

# **Photron FASTCAM Viewer**

**for High-Speed Digital Imaging**

**User's Manual**  
**Ver. 4.1.0.0 E**

**Photron**

The copyright of this manual is held by PHOTRON LIMITED.  
Product specifications and manual contents are subject to change without notice.  
PHOTRON LIMITED bears no responsibility for any results by using our products nor by applying this manual to any operations.

The official name of Windows is the Microsoft Windows Operating System.  
Microsoft, Windows, and the logo of Windows are trademarks of Microsoft Corporation of the United States and/or its affiliated companies.  
Intel and Pentium are trademarks or registered trademarks of Intel Corporation in the United States and/or other countries.

Other company names and product names listed in this manual are trademarks or registered trademarks of their respective companies.  
Product specifications and features can change for the purpose of improvement without notification.

# Introduction

Thank you for purchasing your Photron FASTCAM series high-speed camera system. This manual contains how to install, configuration, operating instructions, and warnings necessary for using the Photron FASTCAM Viewer (referred to as PFV). Read the entire manual before using the software.

If any part of this manual is unclear, refer to the “FAQ and Troubleshooting” and contact Photron using the contact information printed at the back of this manual.

This manual covers PFV Ver. 4.1.0.0

# How to Read This Manual

This section explains the layout of the manual.

## Manual Organization

This manual is organized so that you can perform the basic operation of PFV if reading it from Chapter 1 to Chapter 7. In Chapter 8 or later, the settings and functions of PFV are described in detail. Read the descriptions as necessary.

This manual describes hardware such as high-speed cameras. For details, see the manual attached to the hardware.

### ◆ Chapter 1, Overview

This chapter briefly introduces the functions of PFV and the full picture of the system. It also describes the high-speed cameras and functions that PFV supports, and the recommended operating environment of PC.

### ◆ Chapter 2, Preparation

This chapter describes the installation of PFV, how to start/close it, and its screen.

### ◆ Chapter 3, How to Connect Camera

This chapter describes how to connect a camera and connection settings.

### ◆ Chapter 4, Camera Settings at Live Image

This chapter describes the camera settings necessary for recording.

### ◆ Chapter 5, Recording and Data Playback

This chapter describes the recording method of PFV and how to play back recorded images.

### ◆ Chapter 6, Saving Data

Images recorded on a camera will be lost when the camera is turned off. Therefore, to keep the recorded images, you need to save them from the camera to the PC or an external media such as SD card.

This chapter describes how to save files to them.

### ◆ Chapter 7, Playing Back and Controlling Saved Data

This chapter describes how to play back the data files saved in the PC, data conversion, and others.

### ◆ Chapter 8, How to Use Tool Menu

This chapter describes how to use the tool menu and function panels.

### ◆ Chapter 9, Side Menu

This chapter describes the settings available through the side menu to be displayed by clicking the menu button.

### ◆ Chapter 10, Detailed Setting

This chapter describes the detailed menu to be displayed by clicking the menu button in the upper-left corner of the screen.

### ◆ A. Appendix





This chapter describes the trouble shooting and terms used in this manual.



# Manual Notation

---

Notations used in this manual have the following meanings.

Icon/Symbol	Description
 <b>IMPORTANT</b>	This symbol indicates content that should always be read.
 <b>CAUTION</b>	This symbol indicates instructions that should always be followed when using the software, or things to be careful of when using the software.
 <b>NOTE</b>	This symbol indicates supplementary items to be aware of when using the system.
 <b>REFERENCE</b>	This symbol indicates the location of a reference.
“ ”	This symbol is used to indicate the names of items on a screen, references, dialog names, and connectors.
[ ]	This symbol is used to indicate menu names, and sub-menu names.

# Contents

<b>Chapter 1 Overview</b>	<b>11</b>
1.1. What Is PFV? .....	12
1.1.1. System Components.....	12
1.1.2. What PFV Does .....	13
1.2. Features Supported by Each Camera.....	14
1.3. Recommended Environment.....	18
<b>Chapter 2 Preparation</b>	<b>19</b>
2.1. Installing/Uninstalling PFV.....	20
2.1.1. Before Installation.....	20
2.1.2. How to Install.....	20
2.1.3. How to Uninstall.....	23
2.2. How to Start and Close.....	24
2.3. Description of Screen .....	25
2.3.1. Operation Modes.....	26
<b>Chapter 3 How to Connect Camera</b>	<b>29</b>
3.1. How to Connect Camera.....	30
3.1.1. Checking Camera's IP Address .....	30
3.1.2. Gigabit Ethernet Interface Connection to PC .....	31
3.1.3. Changing PC's IP Address.....	31
3.1.4. Optimizing Ethernet Settings.....	33
3.2. Connecting Multiple Cameras.....	38
3.2.1. To Use Synchronization Signal from Outside for Synchronized Shots with Cameras .....	40
3.2.2. To Use Two Gigabit Ethernet Interface Connectors Simultaneously .....	40
<b>Chapter 4 Camera Settings at Live Image</b>	<b>41</b>
4.1. Displaying/Editing Information .....	42
4.1.1. Warning Display .....	42
4.1.2. Information Items .....	43
4.1.3. Editing Display Information .....	44
4.2. Camera Controls Menu.....	50
4.2.1. Searching for Camera.....	52
4.2.2. Registering Camera.....	53
4.2.3. Changing Camera Name and IP Address.....	54
4.2.4. Saving Setting Information .....	55
4.2.5. Loading Setting Information .....	57
4.3. Setting Shooting Conditions .....	60
4.3.1. Items in "Setup" .....	62

4.3.2.	Lock Function in Trigger Parameter.....	66
4.3.3.	Resolution Lock.....	67
4.3.4.	Detailed Settings of Shutter Speed .....	68
4.3.5.	Lens Control.....	71
4.3.6.	Detailed Settings of Variables.....	74
4.3.7.	Shading Calibration.....	76
4.4.	Setting Trigger Mode.....	77
4.4.1.	What Is Trigger Mode?.....	77
4.4.2.	Supported Trigger Modes by Camera .....	79
4.4.3.	Trigger Mode Types .....	80
4.4.4.	Setting Hardware Image Trigger.....	93

**Chapter 5 Recording and Data Playback 95**

5.1.	Recording.....	96
5.1.1.	For Start, Random, Random Reset, Random Center, and Random Loop Modes.....	96
5.1.2.	For Center, End, and Manual Modes.....	97
5.1.3.	For Random Center and Random Manual Modes.....	98
5.1.4.	For Rec On Cmd Mode .....	99
5.2.	Playing Back Recorded Data.....	100
5.3.	How to Play Back Various Data.....	103
5.3.1.	Playback at Desired Speed.....	103
5.3.2.	Moving to Trigger Frame .....	103
5.3.3.	Moving to Freely Set Trigger Frame .....	104
5.3.4.	Moving to Event Marker .....	105
5.3.5.	Playback with Playback Range Specified.....	106
5.3.6.	Smooth Play.....	106
5.3.7.	Repeat Playback .....	107
5.3.8.	Skip Playback.....	107
5.3.9.	Synchronized Playback .....	108
5.4.	Switching Partitions.....	109

**Chapter 6 Saving Data 110**

6.1.	File Save Settings.....	111
6.2.	Saving Recorded Data.....	113
6.2.1.	Saving Images to PC.....	113
6.2.2.	Edit multiple save path .....	115
6.2.3.	Edit Group Folder Name .....	116
6.2.4.	Edit Subfolder Name .....	117
6.2.5.	Edit File Name .....	118
6.2.6.	Saving Images to SD Card.....	123
6.2.7.	Saving Images to FAST Drive.....	124
6.2.8.	Saving Images to CFast Card.....	125

6.2.9. File Formats and Options.....	126
6.2.10. Save Options.....	132
6.2.11. Save Information Settings .....	134
6.3. Saving Layout .....	137
6.4. Outputting a Report.....	144
6.4.1. Report Key List .....	147
6.5. Saving/Copying a Snapshot Image.....	148

## **Chapter 7 Playing Back and Controlling Saved Data 150**

7.1. Playing Back Data Saved in PC .....	151
7.1.1. Opening Saved Data.....	151
7.1.2. Opening Multiple Saved Data.....	153
7.1.3. Opening Saved Data by Specifying Folder .....	154
7.1.4. Sequentially Playing Back Saved Files Split Up .....	155
7.1.5. Grouping Files .....	156
7.1.6. Re-saving Loaded File .....	158
7.2. Batch Data Conversion.....	160
7.3. Controlling Data in an External Device.....	165
7.3.1. Loading Images from SD Card .....	165
7.3.2. Loading Images from FAST Drive .....	167
7.3.3. Loading Images from CFast Card .....	169

## **Chapter 8 How to Use Tool Menu 171**

8.1. Image Quality Adjustment Tools.....	172
8.1.1. Setting LUT .....	172
8.1.2. Color Adjustment.....	177
8.1.3. Filter Setting.....	179
8.1.4. High Dynamic Range (HDR) .....	183
8.1.5. Binning .....	184
8.2. Simple Measurement Tools.....	185
8.2.1. Simple Measurement .....	185
8.2.2. Manual Tracking .....	187
8.2.3. Calibration.....	189
8.3. Brightness Measurement Tools .....	191
8.3.1. Pseudo Color .....	191
8.3.2. Histogram .....	193
8.3.3. Line Profile .....	195
8.3.4. Brightness Change.....	197
8.4. Image Edit Tools .....	203
8.4.1. Trimming.....	203
8.5. Shooting Assistance Tools .....	204
8.5.1. Camera Synchronization Settings.....	204
8.5.2. Software Image Trigger .....	211

8.5.3.	Overlaying Image.....	218
8.5.4.	Focus Assistance.....	219
8.5.5.	Exposure Alert.....	220
8.6.	Special Display Tools.....	221
8.6.1.	Moving Origin Fixed Display.....	221
8.6.2.	Lens Distortion Correction.....	223
8.6.3.	Keystone Correction.....	226
8.6.4.	Background Subtraction.....	228
8.6.5.	Cycle View.....	230
8.7.	Add-on Functions.....	234
8.7.1.	DAQ Control.....	234
8.7.2.	PFV4 Mobile.....	258
8.7.3.	MCAT.....	264
8.8.	Turning ON/OFF Image Edit Effects.....	283
8.9.	Keyboard Shortcut.....	284
8.10.	Quick Toolbar.....	286

**Chapter 9 Side Menu 287**

9.1.	What Side Menu Does.....	288
9.1.1.	Configuration.....	288
9.1.2.	Switching Between Dark UI / Light UI.....	289
9.1.3.	Export Support File.....	290
9.1.4.	License control.....	292
9.1.5.	Checking Version Information of PFV.....	293

**Chapter 10 Detailed Setting 294**

10.1.	Camera Connection Settings.....	295
10.1.1.	[Camera Connection Settings] Screen.....	296
10.1.2.	[Ethernet settings] Screen.....	297
10.2.	Image Quality Settings.....	299
10.3.	Trigger Settings.....	301
10.4.	Recording Settings.....	302
10.5.	Save Settings.....	306
10.6.	I/O Settings.....	308
10.6.1.	Setting External I/O Port.....	310
10.6.2.	Signal Delay.....	314
10.6.3.	Signal Width.....	315
10.7.	Camera Option Settings.....	316
10.8.	Display Settings.....	318
10.9.	Alert Settings.....	319
10.10.	Preference.....	321
10.10.1.	Time Code Display Settings.....	322

<b>A. Appendix</b>	<b>324</b>
A1. FAQ and Troubleshooting.....	325
Q1.    PFV shows no live image from a camera.....	325
Q2.    Will a camera retain shooting data when being turned off?.....	326
Q3.    Data download is very slow.....	326
Q4.    A camera makes no response even if being turned on, and LEDs on its back will not light up normally.....	326
Q5.    Whole or part of video is streaked.....	326
Q6.    Tone of video is unusual.....	327
Q7.    A screen has dotted noise.....	327
Q8.    How to initialize a camera to the factory default.....	327
Q9.    A message asking whether to delete data is displayed when attempting to change the shooting conditions while using a Mini CX camera.....	328
Q10.   A confirmation message for the camera communication reset while using ST Camera Head.....	328
Q11.   Connecting a camera using 10GbE, but the speed is not high.....	328
Q12.   Every time I add a camera or open a file, a warning appears.....	329
A2. Terms.....	330
A3. Various Information .....	331
A3.1 File Format .....	331
A3.2 Various Information in CIHX File .....	333
A4. CSV File .....	334
A4.1 Type A.....	334
A4.2 Type B .....	335
A4.3 Type C.....	336
A4.4 Type D.....	337
A4.5 Type S.....	338
A4.6 Type A with T .....	339
A4.7 Type B with T.....	340
A5. Contacting Photron.....	341

# 1

## Chapter 1 Overview

This chapter briefly introduces the functions of PFV and the full picture of the system. It also describes the high-speed cameras and functions that PFV supports, and the recommended operating environment of PC Overview.

# 1.1. What Is PFV?

PFV is the software for controlling Photron FASTCAM series high-speed cameras from the PC. Since it has not only basic functions as camera control software, such as camera settings, recording, playback, and save, but also various image processing functions and video editing functions indispensable to high-speed shooting, you can also utilize it widely as a powerful viewer and video editing software.

## 1.1.1. System Components

The basic system components when using a FASTCAM series high-speed camera are shown below.

### FASTCAM series High-Speed cameras

Controls cameras recording/playback/downloading



### Lighting equipment



Synchronizes pulse LED and laser with cameras

### Signal generator



Synchronizes signal generators such as IRIG with cameras

### Lens



Controls lenses  
\* Optional function

### Data logger



Controls the data logger/captures the analog waveform with images  
\* Optional function

### High-capacity data storage



Converts the format of the download data and saves them again

### Image analysis software

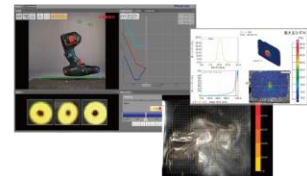

Convert data to a format compatible with image analysis software



## 1.1.2. What PFV Does

### Functions as a camera controller

#### Controlling a high-speed camera

- Displaying live images
- Configuring recording settings and more

➔ See Chapter 3 and 4

#### Recording and viewing the data

- Playing back the images in the memory of the camera
- Setting the section to be played back and the playback speed, and more

➔ See Chapter 5

#### Saving image data

- Downloading images saved in the memory of the camera
- Composing and downloading multiple images, and more

➔ See Chapter 6



### Functions as a data viewer or image authoring software



#### Viewing and editing the data

- Playing back/editing/managing the data
- Converting the data format and more

➔ See Chapter 7

### Providing a lot of functions for image processing, image editing, and features convenient for recording

- Adjusting the brightness, color and quality of images; scaling up/down, rotating, flipping images
- Measuring data from an image, including luminance distribution, line profile, distance to the subject, camera angle
- Lens distortion correction, warp correction, focus assistance, and other user support functions

➔ See Chapter 8 and 9

## 1.2. Features Supported by Each Camera

The high-speed cameras and functions that PFV4 supports are as follows.



### REFERENCE

Refer to the “4.4.2 Supported Trigger Modes by Camera” on page 79. for the trigger modes supported by each camera.

	Nova S6-S20	Nova R2-R5	Mini R5	MH6	Mini CX
PFV Version Supporting	Ver. 4.0.3.2 or later (S20: Ver. 4.0.6.0 or later)	Ver. 4.0.3.2 or later (R5: Ver. 4.0.6.0 or later, R3: Ver. 4.0.6.1 or later)	Ver. 4.1.0.0 or later	Ver. 4.0.1 or later ST Cam: Ver. 4.0.4.1 or later	Ver. 4.0.1.1 or later
Random/Random Trigger Recording Count	✓	✓	✓		
Variable Frame Rate / Variable Resolution	✓	✓	✓		
Auto Exposure	✓	✓			
Exposure Time Measurement During Auto Exposure	✓	✓			
Dual-Slope Shutter	✓	✓			
Shutter Lock Mode	✓	✓	✓	✓	
Resolution Lock Mode	✓	✓	✓		
Fan Control	✓	✓	✓		
Lens Control Option	✓	✓	✓		
IRIG Input	✓	✓	✓	✓	✓
Choosing Time of IRIG Time Stamp for Exposure Start or End	✓	✓	✓	✓	
IRIG Synchronization	✓	✓	✓		✓
Variable Frequency Synchronization	✓	✓	✓		✓
DAQ control	✓	✓	✓	✓	
Measurement of Time Between Trigger Input and Exposure Start					
Signal Delay Setting	✓	✓	✓	✓	✓ (TRIG IN only)
Signal Width Setting	✓	✓	✓	✓	
Sync output rate Setting	✓	✓	✓	✓	
Event Marker	✓	✓	✓	✓	
Straddling Pulse Signal Output					
Operating Bit Switching	✓ (S20 only)				
Save While Recording	✓	✓	✓		
Hardware Image Trigger					
Mechanical Shutter Control	✓	✓	✓		
Maximum Memory Partitioning	128	128	64		
G Sensor Trigger				✓	✓
Temperature Sensor				✓	✓
User Switch Setting				✓	
Device Date/Clock				✓	✓
Save to Nonvolatile Media* (*1 FAST Drive, *2 SD card, *3 CFast Card, *4 Internal SSD card)	✓ *1	✓ *1		✓ *4	✓ *3
HD SDI Output	✓	✓			
HDMI					✓
Direct Start Setting	✓	✓	✓	✓	
10 Gigabit Ethernet	✓	✓	✓		

	SA-Z	SA-X2	Mini AX 50/100/200	Mini UX 50/100	Mini WX 50/100
PFV Version Supporting	Ver. 4.0.0 or later	Ver. 4.0.0 or later	Ver. 4.0.0 or later	Ver. 4.0.0 or later	Ver. 4.0.0 or later
Random/Random Trigger Recording Count	✓	✓			
Variable Frame Rate / Variable Resolution	✓	✓	✓	✓	✓
Auto Exposure	✓	✓			
Exposure Time Measurement During Auto Exposure	✓	✓			
Dual-Slope Shutter	✓	✓	✓		✓
Shutter Lock Mode	✓	✓	✓	✓	✓
Resolution Lock Mode	✓	✓	✓	✓	✓
Fan Control	✓	✓	✓	✓	✓
Lens Control Option	✓	✓			
IRIG Input	✓	✓	✓	✓	✓
Choosing Time of IRIG Time Stamp for Exposure Start or End	✓	✓			
IRIG Synchronization	✓	✓	✓		✓
Variable Frequency Synchronization	✓	✓	✓	✓	✓
DAQ control	✓	✓	✓	✓	✓
Measurement of Time Between Trigger Input and Exposure Start	✓	✓			
Signal Delay Setting	✓	✓	✓	✓	✓
Signal Width Setting	✓	✓	✓	✓	✓
Sync output rate Setting	✓	✓	✓	✓	✓
Event Marker	✓	✓	✓	✓	✓
Straddling Pulse Signal Output	✓	✓			
Operating Bit Switching	✓	✓			
Save While Recording	✓	✓	✓		✓
Hardware Image Trigger	✓	✓			
Mechanical Shutter Control	✓	✓	✓		✓
Maximum Memory Partitioning	128	128	64	64	64
G Sensor Trigger					
Temperature Sensor					
User Switch Setting	✓	✓			
Device Date/Clock	✓	✓			
Save to Nonvolatile Media* (*1 FAST Drive, *2 SD card, *3 CFast Card, *4 Internal SSD card)	✓ *1,2	✓ *1,2			
HD SDI Output	✓	✓			
HDMI					
Direct Start Setting	✓			✓	✓
10 Gigabit Ethernet					

	Multi	SA1.1/SA4/ SA5	MH4	MC2.1	SA2/SA6
PFV Version Supporting	Ver. 4.0.0 or later	Ver. 4.0.0 or later	Ver. 4.0.0 or later	Ver. 4.0.3 or later	Ver. 4.0.0 or later
Random/Random Trigger Recording Count					
Variable Frame Rate / Variable Resolution	✓	✓			✓
Auto Exposure	✓	✓			✓
Exposure Time Measurement During Auto Exposure					
Dual-Slope Shutter		✓			✓
Shutter Lock Mode	✓	✓	✓	✓	✓
Resolution Lock Mode	✓		✓	✓	✓
Fan Control	✓				
Lens Control Option	✓	✓			✓
IRIG Input	✓	✓			✓
Choosing Time of IRIG Time Stamp for Exposure Start or End					
IRIG Synchronization	✓	✓			
Variable Frequency Synchronization	✓				
DAQ control	✓	✓	✓	✓	✓
Measurement of Time Between Trigger Input and Exposure Start					
Signal Delay Setting	✓	✓	✓		✓
Signal Width Setting	✓	✓	✓	✓	✓
Sync output rate Setting	✓	✓	✓	✓	✓
Event Marker	✓	✓	✓		✓
Straddling Pulse Signal Output					
Operating Bit Switching		✓			
Save While Recording					
Hardware Image Trigger					
Mechanical Shutter Control					
Maximum Memory Partitioning	64	64			64
G Sensor Trigger					
Temperature Sensor					
User Switch Setting	✓	✓	✓	✓	✓
Device Date/Clock	✓				
Save to Nonvolatile Media* (*1 FAST Drive, *2 SD card, *3 CFast Card, *4 Internal SSD card)	✓ *1				
HD SDI Output	✓	✓			✓
HDMI					
Direct Start Setting	✓		✓	✓	
10 Gigabit Ethernet					

	SA3	SA7/SA8
PFV Version Supporting	Ver. 4.0.0 or later	Ver. 4.0.0 or later
Random/Random Trigger Recording Count		
Variable Frame Rate / Variable Resolution	✓	
Auto Exposure		
Exposure Time Measurement During Auto Exposure		
Dual-Slope Shutter	✓	
Shutter Lock Mode	✓	✓
Resolution Lock Mode		
Fan Control		
Lens Control Option		
IRIG Input	✓	
Choosing Time of IRIG Time Stamp for Exposure Start or End		
IRIG Synchronization		
Variable Frequency Synchronization		
DAQ control	✓	✓
Measurement of Time Between Trigger Input and Exposure Start		
Signal Delay Setting	✓	✓
Signal Width Setting	✓	✓
Sync output rate Setting	✓	✓
Event Marker	✓	✓
Straddling Pulse Signal Output		
Operating Bit Switching	✓	
Save While Recording		
Hardware Image Trigger		
Mechanical Shutter Control		
Memory Partitioning	8	8
G Sensor Trigger		
Temperature Sensor		
User Switch Setting		
Device Date/Clock		
Save to Nonvolatile Media* (*1 FAST Drive, *2 SD card, *3 CFast Card, *4 Internal SSD card)		
HD SDI Output		
HDMI		
Direct Start Setting	✓	✓
10 Gigabit Ethernet		

Some of the features may not be supported depending on when the camera was purchased.

## 1.3. Recommended Environment

The recommended operating environment of the PC for running PFV4 is as follows.

Item	Description
OS	Windows 11 Pro, Windows 11 Enterprise, Windows 11 Education, Windows 10 Pro, Windows 10 Enterprise, Windows 10 Education, * 64-bit version is essential.
CPU	Intel Core i5 or higher (Intel Core i7 or higher is recommended) * SSE2 is essential.
Memory	Above 4 GB (above 8 GB is recommended)
Hard Disk or SSD	Above 1 GB of free space * When downloading the data in GRAW format, an NVMe SSD (M.2 SSD) is recommended.
Graphics	Intel HD Graphics or higher NVIDIA graphics card VRAM 4 GB or higher is recommended. * OpenGL3.0 or higher is essential. * AMD graphics card is not supported. * When connecting multiple cameras, prepare a graphics card of the recommended memory capacity (4 GB).
Display Resolution	24-bit color or higher of Full HD (1,920 x 1,080) is recommended. * WXGA (1,280 x 768) is also available, but some items may not be displayed.
Others	<ul style="list-style-type: none"> <li>• A high-capacity hard disk or removable media drive for saving recorded image data</li> <li>• A DVD-ROM drive (for use during installation)</li> <li>• When using the Gigabit Ethernet connection, a 1000BASE-T capable NIC with “Jumbo Frame” support is recommended.</li> <li>• When using the 10 Gigabit Ethernet connection and downloading the data in GRAW format, a 10GBASE-T capable NIC with “Jumbo Frame” support and an NVMe SSD (M.2 SSD) are recommended.</li> <li>• SD Card Reader (for playing back images saved in an SD card)</li> <li>• USB Port (for controlling a camera or playing back images saved in a FAST Drive via USB)</li> <li>• CFast Card Reader (for playing back images saved in an CFast card)</li> </ul> <p>Depending on the image to display, better operating environment than is recommended might be required.</p>

### NOTE

- We do not guarantee the remote desktop operation of a PC running PFV4. However, it may work in some cases, so contact our technical personnel for assistance.
- The recommended operating environment represents a typical specification and does not guarantee the operating performance. Contact Photron for support in selecting a PC.
- Depending on the virus security software you are using, there may be a slowdown when downloading data. Check with your company’s security department if necessary.

# 2

## Chapter 2 Preparation

This chapter describes the installation of PFV, how to start/close it, and its screen.

## 2.1. Installing/Uninstalling PFV

Here, the installation of PFV is described. Read “2.1.1 Before Installation” on page 20 and “2.1.2 How to Install” on page 20 in this order.

### 2.1.1. Before Installation

Prepare the installation DVD of PFV software. See the “1.2 Features Supported by Each Camera” on page 14 for the supported cameras and “1.3 Recommended Environment” on page 18 for the supported PC.

There is no problem installing PFV with the default settings. However, if necessary, the following items can be set during the installation procedure.

- Changing the destination folder of installation  
The default is “C:\Program Files\Photron\Photron FASTCAM Viewer 4”. Specify the folder to change it.
- Selecting components  
The selectable components will be displayed. Select the components you want to use.
- Changing the folder name where the shortcuts of the start menu are  
The default is “Photron FASTCAM Viewer 4”. Specify the folder name to change it.

### 2.1.2. How to Install

Go to the following procedure to install it.

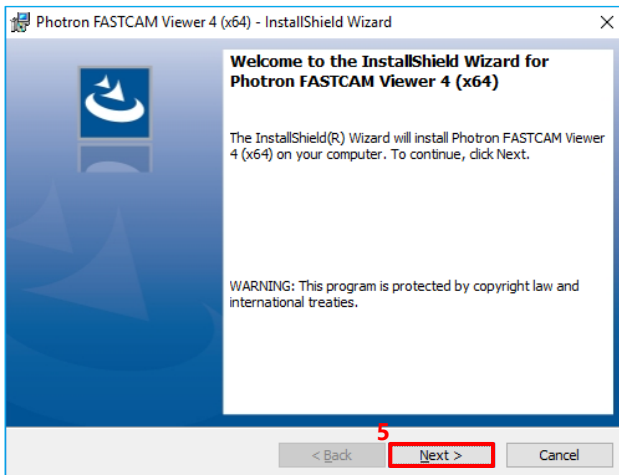

1. Load the PFV installation DVD in the optical drive.
  2. Double-click the DVD drive under “Computer”.
  3. Double-click “PFV4\_x64.exe”.
- The setup program will start. Depending upon the OS being used, the confirmation screen of the user account control will be displayed.
4. Click the [Yes] button.
  5. Click the [Next] button.
- The license agreement will be displayed.



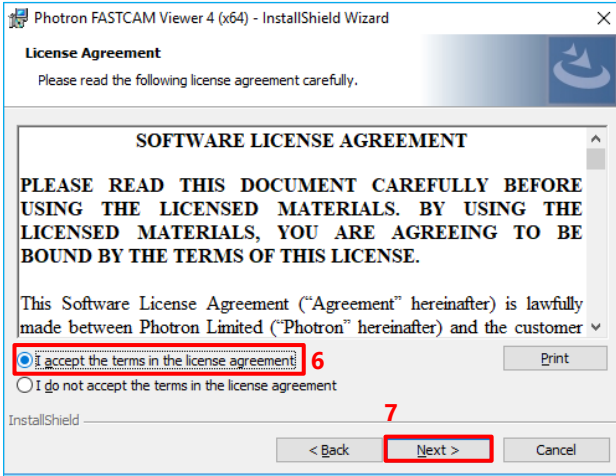

6. Check the content and select “I accept the terms in the license agreement”.
7. Click the [Next] button.

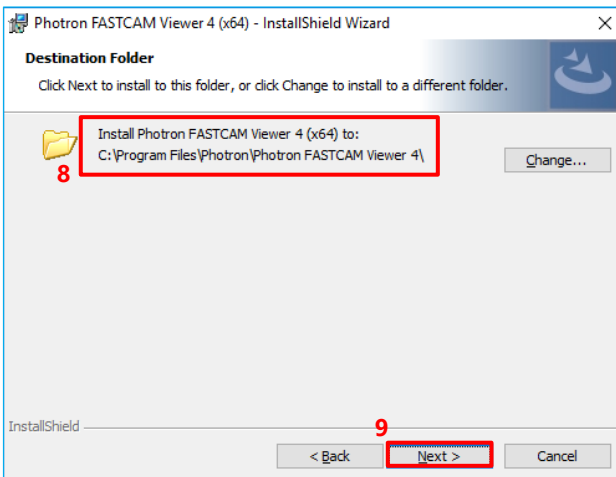

8. Specify the installation destination.  
The default is “C:\Program Files\photron\Photron FASTCAM Viewer 4\”.  
To specify another installation destination, click the [Change] button and change it to any desired location.
9. Click the [Next] button.

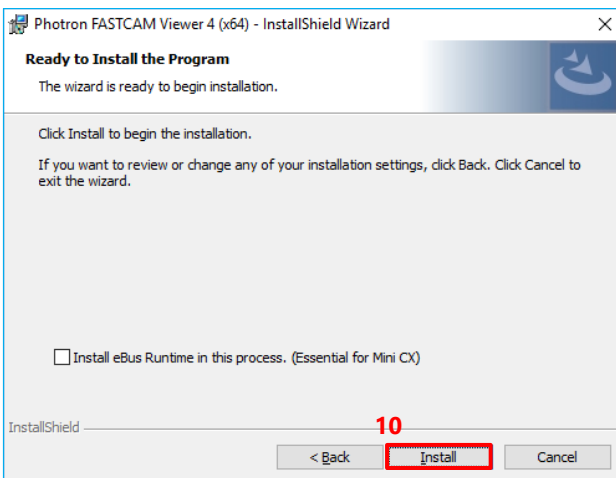

10. Click the [Install] button.  
The installation will start.  
When the installation has been completed, the next screen will be displayed.

**NOTE**

Be sure to check to “Install eBus Runtime in this process” before installation to use Mini CX.

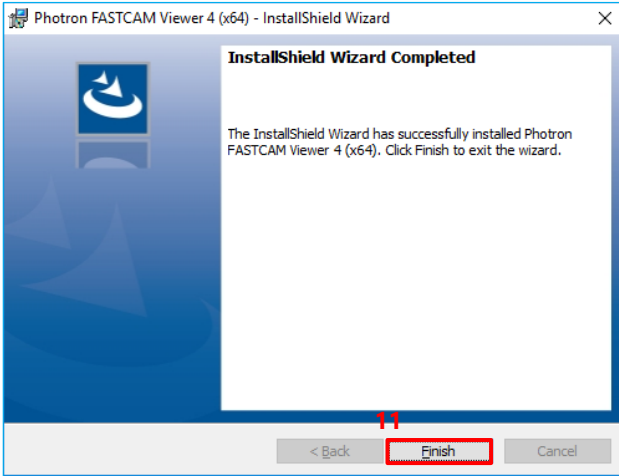

11. Click the [Finish] button.

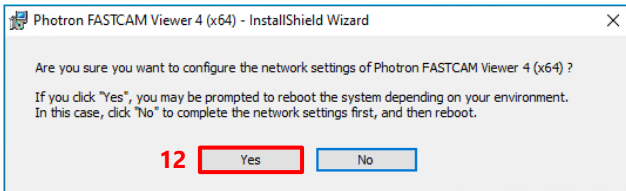

12. If you want to configure network settings, click the [Yes] button. With the network settings, the IP address and other information on the PC can be set to match the camera.

The installation is now complete.

### NOTE

- The network settings for PFV4 can be configured from [MENU] - [Configuration] - [Connection] - [PC network settings] later.
- PFV is updatable. To update, double-click and execute the installation program (PFV4\_x64.exe) for the new version.

## 2.1.3. How to Uninstall

Go to the following procedure to uninstall PFV4.

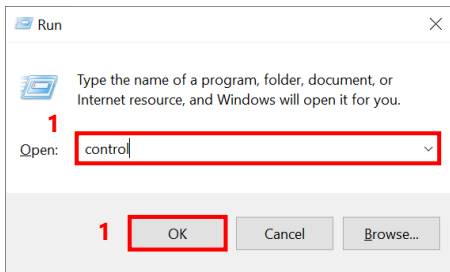

1. Press the [Win] key and [R] key, enter “control” and click the [OK] button, then click [Uninstall a program].

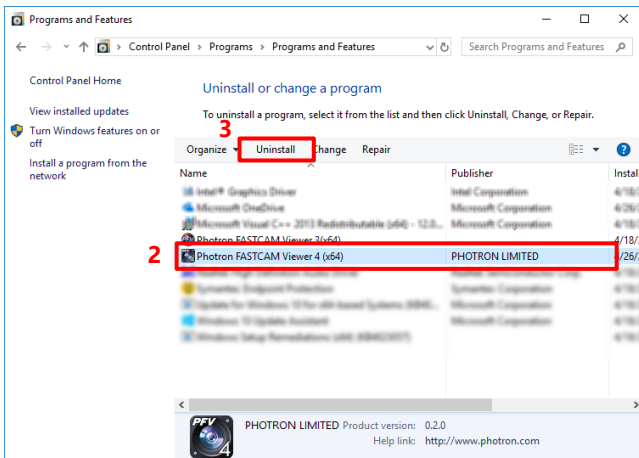
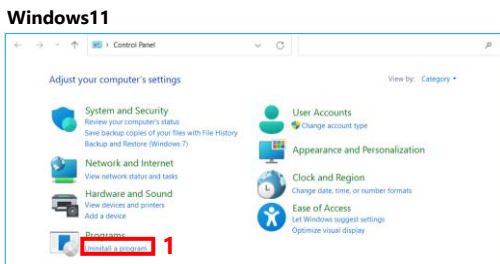
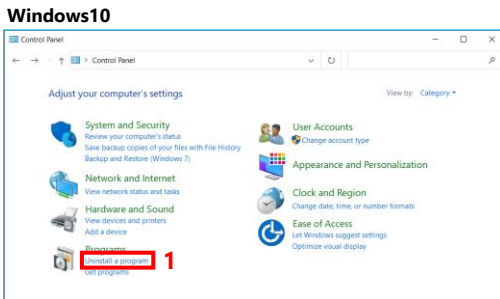

2. Select [Photron FASTCAM Viewer4 (x64)] from the displayed list.
3. Click the [Uninstall] button.  
The screen with the message “Are you sure you want to uninstall Photron FASTCAM Viewer 4(x64)?” will be displayed.
4. Click the [Yes] button.

The uninstallation is now complete.

## 2.2. How to Start and Close

To start PFV4, perform the following procedure.

1. Click the [Start] button - [Photron FASTCAM Viewer 4] - [PFV4(x64)] (or [PFV4]), double-click  on the desktop, or double-click CIHX/PCSX file.

PFV starts.

PFV4

When a camera is connected, the software starts in LIVE mode and a live video from the camera is displayed.  
When a camera is not connected, the software starts in FILE mode and no image is displayed.

### NOTE

The state of PFV after startup depends on the procedure for opening it.

- Open from [Start] button or shortcut icon: Starts up in LIVE mode or FILE mode.
- Double-click on a cihx file: Starts with the video opened in FILE mode
- Double-click on a pcsx file: Starts with the settings in place when the pcsx file is output.

### REFERENCE

If no image is displayed, see “Chapter 3 How to Connect Camera” on page 29.

To close PFV4, perform the following procedure.

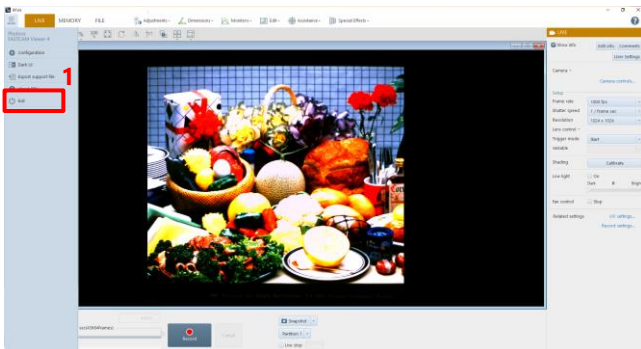

1. Click the menu button - [Exit].  
The exit message is displayed.

Do not turn off the camera while the message is being displayed.

## 2.3. Description of Screen

When PFV starts, the following screen is displayed. Here, names of parts of this screen are described.



Item	Name	Function
(A)	Menu button	Displays the menu for settings etc. about the software itself.
(B)	Mode switching tab	Switches modes between “LIVE”, “MEMORY”, and “FILE”. Each mode has the following features. LIVE mode: You can prepare for shooting and start recording while checking the live image from a camera. MEMORY mode: You can check the memory image inside a camera before saving data. FILE mode: You can check the saved images.
(C)	Tool menu bar	Displays the tools about settings. Setting items for the selected tool are displayed on the function panel. Available items displayed vary according to the mode.
(D)	Help button	Starts the PFV4 User’s Manual.
(E)	Minimize button	Minimizes the screen of PFV. To show the screen of PFV, click the icon of PFV on the taskbar.
(F)	Maximize/Restore button	Maximizes the window or restores it to the original size.
(G)	Close button	Closes PFV.
(H)	Quick toolbar	Displays the tools used frequently and in combination with other tools.
(I)	Video display region	This is a region where video is displayed.
(J)	Effect status bar	Displays the icons of applied effects, which are set on the tool menu etc. In addition, clicking an icon cancels the effect temporarily.
(K)	Function panel	Displays the setting items for setting or controlling a tool selected on the tool menu. Items displayed vary with the mode.
(L)	Recording/Playback panel	Displays the buttons and setting items about playing back or saving video. Items displayed vary with the mode. In addition, it is not available if there is no view window in the video display region. Put a check in the box of [Live stop] which is shown in LIVE mode to stop the live image.
(M)	View window	Displays the video from a camera, shot video, or others.

## 2.3.1. Operation Modes

PFV has three modes: LIVE mode, MEMORY mode, and FILE mode. Its screen and function panel vary with the mode. Here, each mode is described.

### ■ LIVE mode

Images being obtained by the currently connected camera are displayed. When multiple cameras are connected, images from each camera are displayed. (The same is true for multi-head cameras.) The camera name (or the IP address, depending on the setting) is displayed as a title. When PFV starts in LIVE mode, images from all cameras will be displayed, with all the connected ones selected.



### REFERENCE

For rearranging or fitting windows, see “8.10 Quick Toolbar” on page 286.

When multiple windows are displayed, if you select one of them, the camera corresponding to the selected window will be selected and the function panel will display the information on the selected camera.

#### ● Function panel in LIVE mode

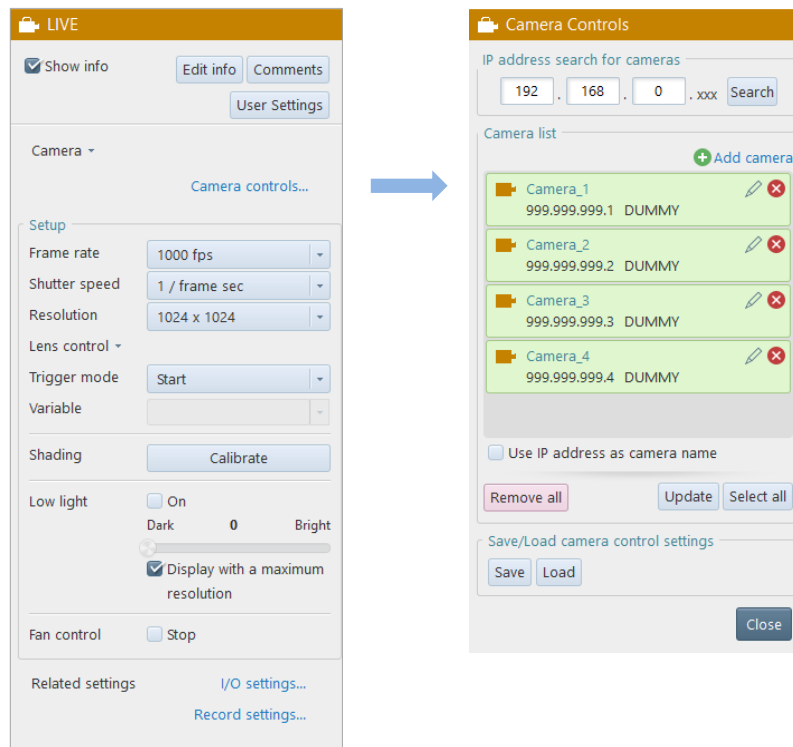

### REFERENCE

For details of the setting panel on the function panel in LIVE mode, see “4.3 Setting Shooting Conditions” on page 60.

## ■ MEMORY mode

Images saved in the memory of the currently connected camera are displayed. When multiple cameras are connected, images saved in the memory of each camera are displayed. (The same is true for multi-head cameras.) The camera name (or the IP address, depending on the setting) is displayed as a title.

When multiple windows are displayed, if you select one of them, the camera corresponding to the selected window will be selected and the function panel will display the information on the selected camera.

### ● Function panel in MEMORY mode

Here, the function panel in MEMORY mode is described.

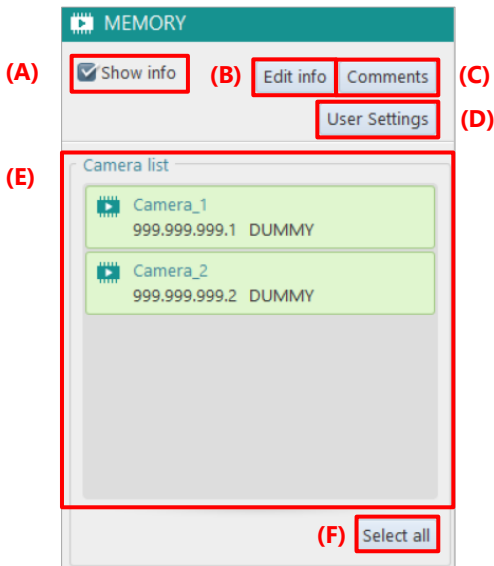

Item	Name	Function
(A)	Show info	Checking this displays the set information.
(B)	Edit info	Clicking this button allows you to select the information to display.
(C)	Comments	Clicking this button allows you to enter a comment for the specified camera window or image.
(D)	User Settings	Clicking this button allows you to add information to be displayed at the upper left of the view window. For details, see “[User Settings] screen” on page 46.
(E)	Camera list	Displays the connected cameras in list form.
(F)	Select all	Displays the images from all the connected cameras.

## ■ FILE mode

Data images saved in media are displayed on each window. The filename is displayed as a title (according to the setting of [File name], the name displayed can be selected between a full path name and a filename only).

When you open a file from an SD card, the temporary name [Viewer No. xx] assigned automatically when it is opened will be displayed because no filename exists.

### ● Function panel in FILE mode

Here, the function panel in FILE mode is described.

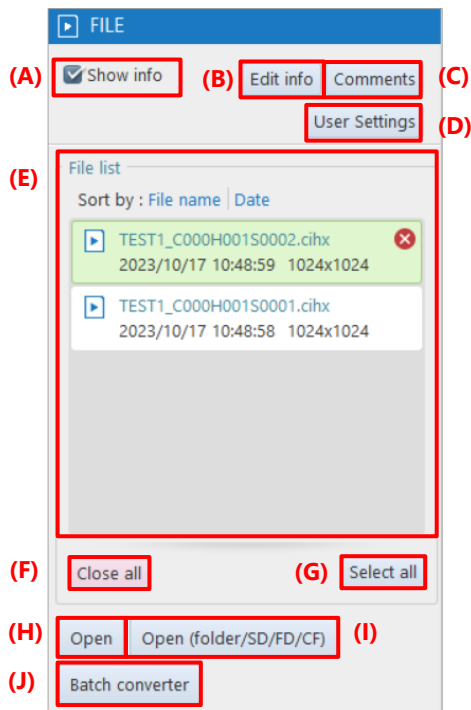

Item	Name	Function
(A)	Show info	Checking this displays the set information.
(B)	Edit info	Clicking this item allows you to select the information to display.
(C)	Comments	Clicking this item allows you to enter a comment for the camera.
(D)	User Settings	Clicking this item allows you to add information to be displayed at the upper left of the view window. For details, see “[User Settings] screen” on page 46.
(E)	File list	Displays the files being opened on PFV in list form.
(F)	Close all	Remove all the images shown in the File list.
(G)	Select all	Displays all the images displayed on the File list.
(H)	Open	Displays the file you have selected.
(I)	Open (folder/SD/FD/CF)	Displays the files in the folders / SD / FAST Drive / CFast card.
(J)	Batch converter	Starts the batch converter.



# 3

## Chapter 3 How to Connect Camera

This chapter describes how to connect a camera and connection settings.

## 3.1. How to Connect Camera

This section describes how to connect a camera and the PC using Gigabit Ethernet interface connection. Since using a LAN cable to connect the camera and the PC, you need to check and set their IP addresses.

When using PFV as a viewer for recorded image, proceed to “Chapter 7 Playing Back and Controlling Saved Data” on page 150.

Items to prepare

- Camera
- PC
- LAN cable
  - 1GbE connection: Category 5e or higher cable
  - 10GbE connection: Category 7 or higher STP (Shielded Twisted Pair) cable

### 3.1.1. Checking Camera’s IP Address

The IP address is assigned to the high-speed camera in advance. The factory default IP address can be found on a label attached to the camera.

Do not set this address as the IP address of your PC.

If the same IP address is set to the PC, a conflict occurs between the camera and the PC, resulting in the camera not being recognized, live images not being displayed, etc.

#### ■ Factory default IP address of camera

IP Address: 192.168.0.010  
Subnet mask: 255.255.255.000  
Default Gateway: 000.000.000.000

#### ■ Example IP address

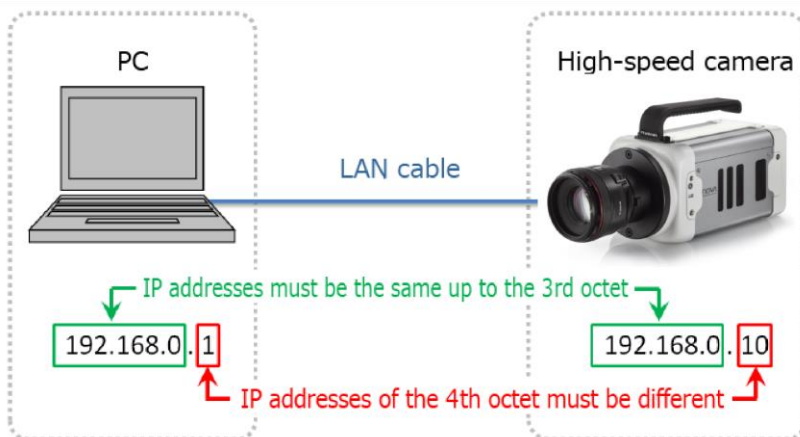

#### IMPORTANT

- High-speed camera’s IP address and PC’s IP address must be the same up to the 3rd octet and be different after the 4th octet. Since the 4th octet of camera’s IP address is 10 by factory default, that of PC’s IP address must be any numeral (1 to 254, except 10).
- When connecting two or more cameras, see “3.2 Connecting Multiple Cameras” on page 38 to set them.



## CAUTION

- If, for any cause, you have changed and lost camera's IP address, reset the camera settings. By default, it is set to "192. 168. 0. 10".  
For how to reset them, see the camera's hardware manual.
- Depending on the environment, 10GbE connection may not be stable. Check the operation in advance or contact Photron for support.

### 3.1.2. Gigabit Ethernet Interface Connection to PC

1. Insert a LAN cable into the LAN connector.
2. Insert the other connector of the LAN cable into PC's LAN connector.  
For PC's LAN connector, see the PC's hardware manual.

### 3.1.3. Changing PC's IP Address

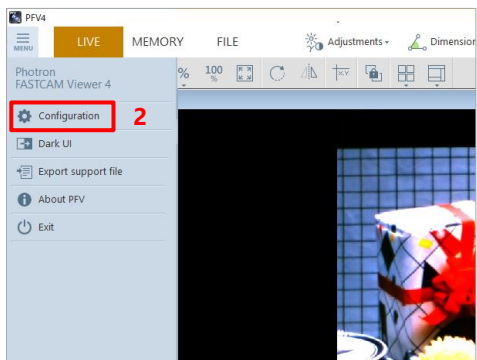

1. Start PFV.
2. Click [Configuration] from the menu.  
The "Configuration" screen is displayed.

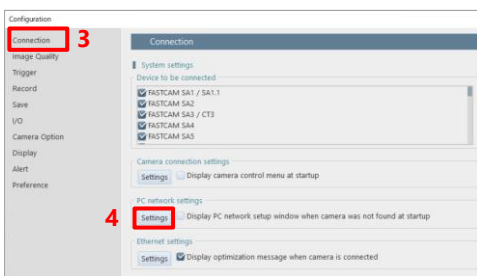

3. Click [Connection].  
The "Connection" screen is displayed.
4. Click the [Settings] button under the "PC network setting".  
The "PC network settings" dialog is displayed.

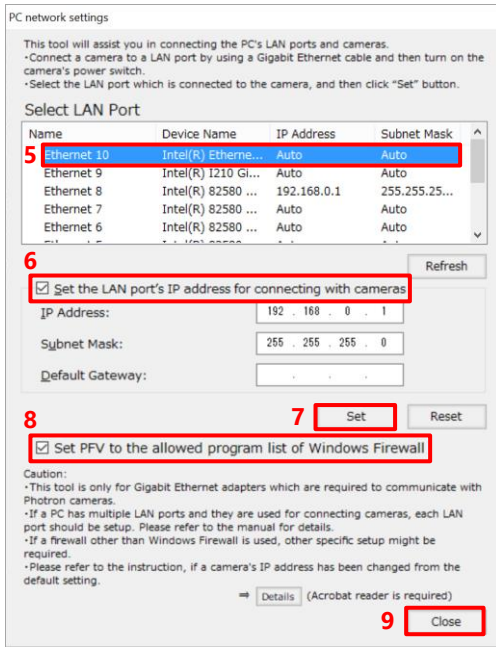

5. Select the adapter connected to the camera to be configured.
6. Check "Set the LAN port's IP address for connecting with cameras" as necessary.  
Checked: The input IP address, subnet mask, and gateway will be used.  
Unchecked: A DHCP connection will be used without using IP etc.
7. Click the [Set] button.  
The settings are applied.
8. Be sure to check [Set PFV to the allowed program list of Windows Firewall].  
Checked: An exception setting will be added.  
Unchecked: The exception setting will be deleted.  
If the camera is not recognized, [DEVICE SETTINGS] is displayed on the function panel.
9. Click the [Close] button.  
When the setting process is complete, a message will be displayed.
10. Click the [OK] button.
11. Restart PFV or the PC.

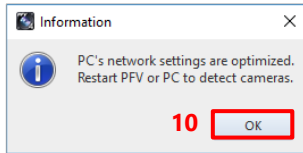

## NOTE

- Clicking the [Reset] button returns the settings to default.
- When using MH6, it is possible to connect it to the PC by using a USB cable (3.0). When the camera and PC are connected by using a USB cable, the serial number is displayed instead of an IP address.
- If both a LAN cable and USB cable are used for connection, the LAN cable is recognized preferentially.  
Do not connect both USB and LAN at the same time, as this may cause problems.
- To use a USB cable, a driver must be installed in advance.

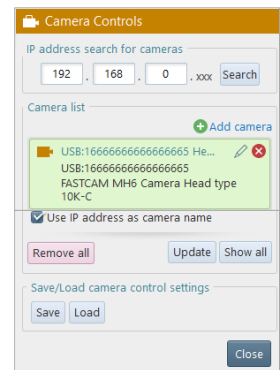

### 3.1.4. Optimizing Ethernet Settings

PFV4 optimization function optimizes the PC's network card settings, the PC's power settings, and packet settings.



#### CAUTION

- An optimization using the [Optimize] button does not work for Mini CX and MH6 connected via USB.
- Confirm the camera to use is shown in the camera list before optimizing.  
When the camera or the network adapter to use is changed, perform an optimization again.

#### ■ Optimize from confirmation message (optimize when camera is detected/added)

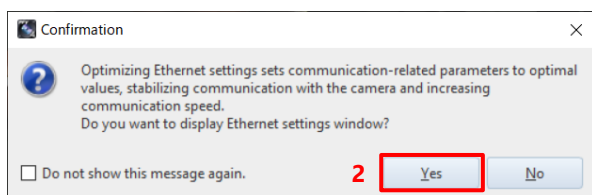

1. Start PFV.

The camera is searched, and a message is displayed.

2. Click the [Yes] button.

The "Ethernet settings" window is displayed.

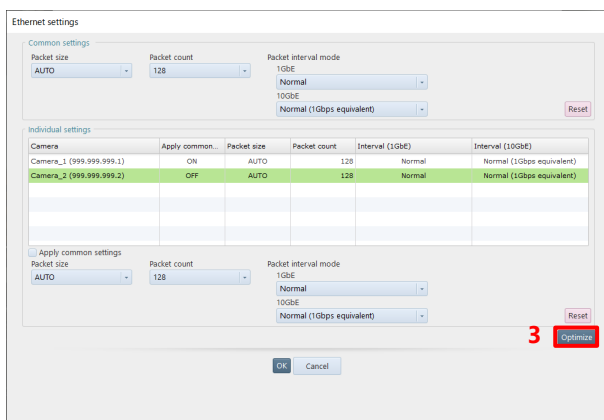

3. Click the [Optimize] button.

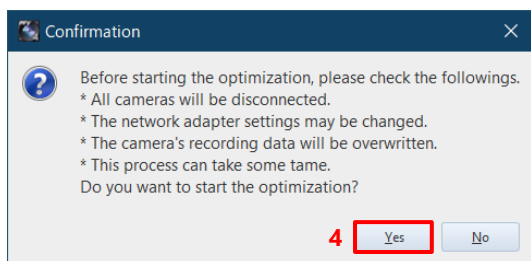

4. Click the [Yes] button.

Optimization starts.

Depending upon the OS being used, the confirmation screen of the user account control will be displayed. Click the [Yes] button.

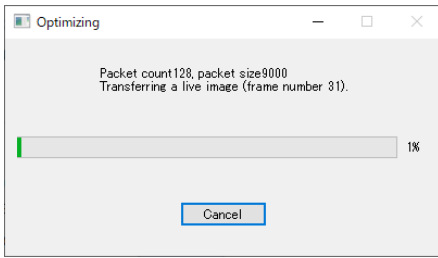

Optimization proceeding.  
 (required time: around 2 to 5 min.)  
 ※ It may take longer time under an unstable connection.

Click the [Cancel] button to cancel the optimization and return the setting before changing.

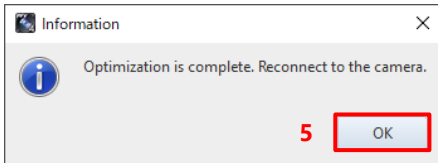

5. Click the [OK] button and reconnect to the camera.

### ■ Optimize from Camera Controls (optimize after adding camera)

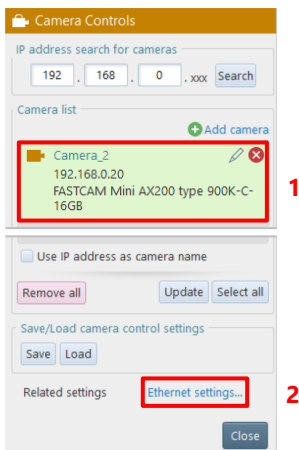

1. Confirm the camera to use is shown in the camera list.
2. Click [Ethernet setting] from related settings.  
 The “Ethernet settings” window is displayed.

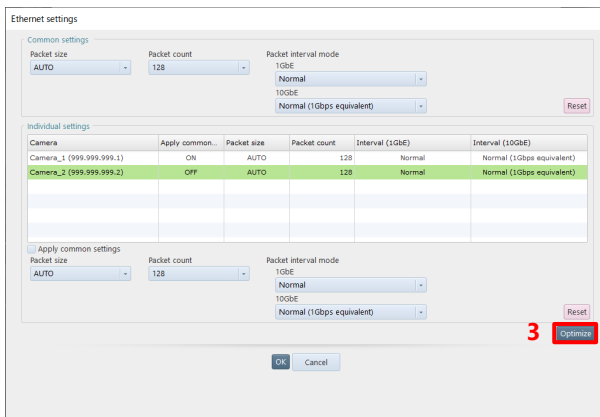

3. Click the [Optimize] button.

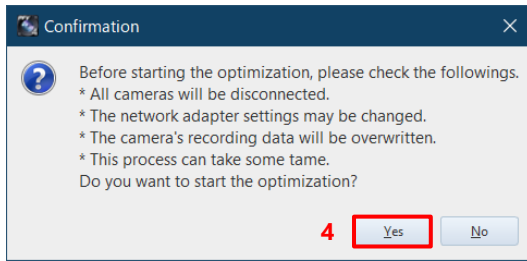

4. Click the [Yes] button.

Optimization starts.

Depending upon the OS being used, the confirmation screen of the user account control will be displayed. Click the [Yes] button.

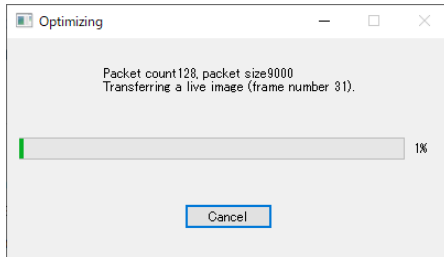

Optimization proceeding.  
(required time: around 2 to 5 min.)

※ It may take longer time under an unstable connection.

Click the [Cancel] button to cancel the optimization and return the setting before changing.

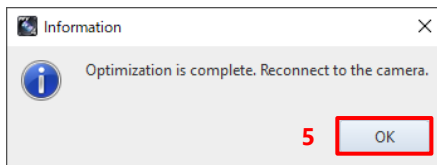

5. Click the [OK] button and reconnect to the camera.

## NOTE

- Optimization can be performed even when 1GbE / 10GbE cameras are connected in a mixed configuration.
- Optimization feature optimizes the following communication and settings.
  - LIVE communication in LIVE mode
  - Data download communication in MEMORY mode
  - Packet size, packet count, and packet interval mode
  - Network card settings and power plan of PC
- In case the communication remains unstable even after optimization, modify packet size, packet count, and packet interval mode manually.  
A smaller value will more stabilize the communication, but will more reduce the communication rate at the same time.
- The optimization confirmation message is displayed each time a camera is added. If you do not want this message to appear, check the “Do not show this message again”.  
To display the message again, check “Open Ethernet settings when camera is connected” in the Ethernet settings under [MENU] - [Connection].

## ■ Adjust Packet Settings Manually

### NOTE

- Change the Ethernet settings following the below procedure if the communication is unstable even after the optimization or to set at your discretion. Normally this item does not require a change.

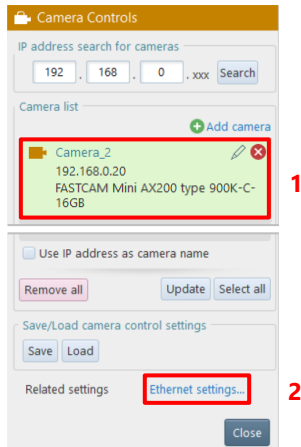

1. Confirm the camera to use is shown in the camera list.
2. Click [Ethernet setting] from related settings.  
The “Ethernet settings” window is displayed.

### ■ To configure settings for multiple cameras at once

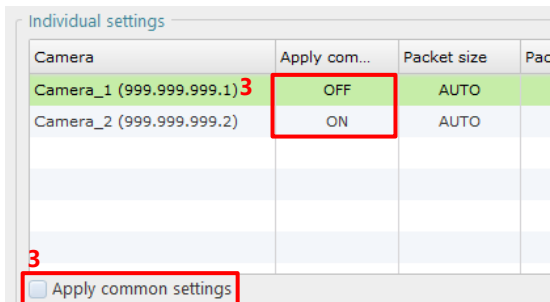

3. Check if the [Apply common settings] status of the camera is set to ON. Select the camera and check the [Apply common settings] checkbox.

If it is set to OFF, the camera will be excluded from the settings in the Common Settings field.

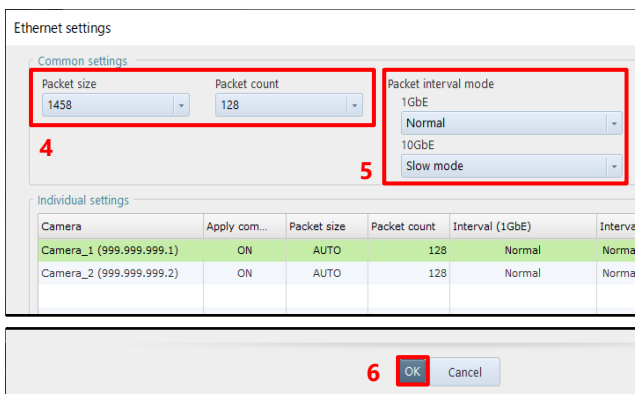

4. Select Packet size and Packet count in the Common settings column.
5. Select Packet interval mode.  
For a 10GbE connection, change the Packet interval mode setting to increase the communication speed. When set to Slow mode, the speed will be low.
6. Click the [OK] button.



- To configure settings for each camera respectively

Individual settings

Camera	Apply com...	Packet size	Pac
Camera_1 (999.999.999.1)	OFF	AUTO	
Camera_2 (999.999.999.2)	ON	AUTO	

3

Apply common settings

3. Select the camera you want to configure individually from the list and uncheck [Use common settings].

Individual settings

Camera	Apply com...	Packet size	Packet count	Interval (1GbE)	Interval
Camera_1 (999.999.999.1)	OFF	AUTO	128	Normal	Normal
Camera_2 (999.999.999.2)	ON	AUTO	128	Normal	Normal

4

Apply common settings

Packet size: AUTO

Packet count: 128

Packet interval mode: Normal (1Gbps equivalent)

5

6 OK Cancel

4. Select Packet size and Packet count in the Common settings column.
5. Select Packet interval mode. For a 10GbE connection, change the Packet interval mode setting to increase the communication speed. When set to Slow mode, the speed will be low.
6. Click the [OK] button.



## CAUTION

The maximum packet count depends on the camera; Nova has a maximum of 1024, and other models have a maximum of 256. You can set the packet count to 256 or more for models other than Nova, but it will work with 256.



## NOTE

- By default, the packet size is set to “1458”, the packet count to “32”, and the packet interval mode to “Normal mode” respectively. Click the [Reset] button to return to these settings.
- A larger value increases the communication rate and the chance of packet loss at the same time. Optimize the value after checking the communication status.

## 3.2. Connecting Multiple Cameras

PFV allows multiple high-speed cameras to be connected to a single PC to control them collectively. Cameras and the PC are connected as shown below.

### When a hub is used

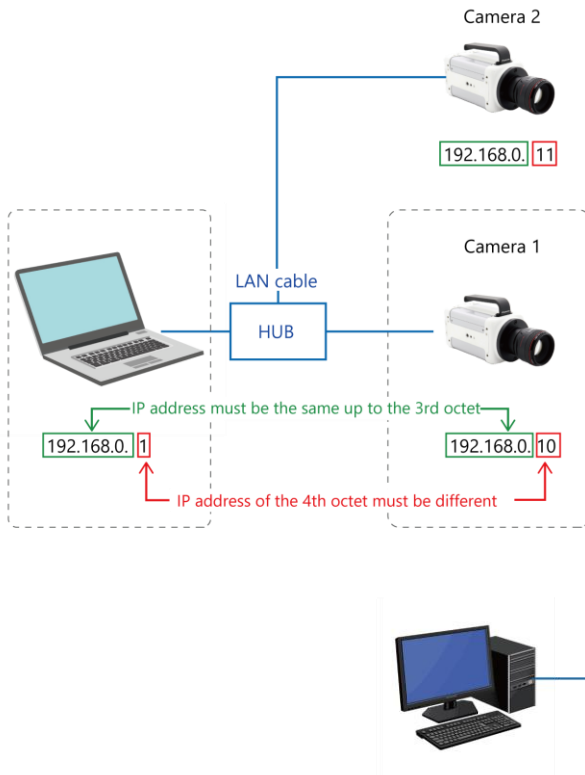

### When multiple network cards are used

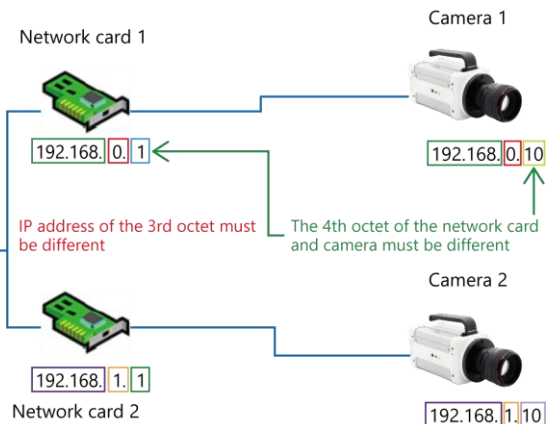

The high-speed camera is assigned its IP address beforehand, and it is indicated on the label affixed to the camera body.

When you set PC's IP address, it must be the same as camera's IP address up to the 3rd octet and be different after the 4th octet.

### CAUTION

- Do not assign the PC the same IP address as that of the camera. Setting the same IP address will result in such phenomena as preventing the camera from being recognized or live images from being displayed.
- When changing the IP address, connect cameras one by one.  
For how to change the IP address, see "4.2.3 Changing Camera Name and IP Address" on page 54.
- When multiple network cards are used, automatic search for IP address in "4.2 Camera Controls Menu" on page 50 cannot connect to multiple cameras.  
Add the camera to connect to "Camera list" and perform a search.
- When using a hub and connecting cameras to the hub additionally, it may take about one minute for the newly connected camera to become searchable.

Here, the connection for synchronized shots with two cameras is described.

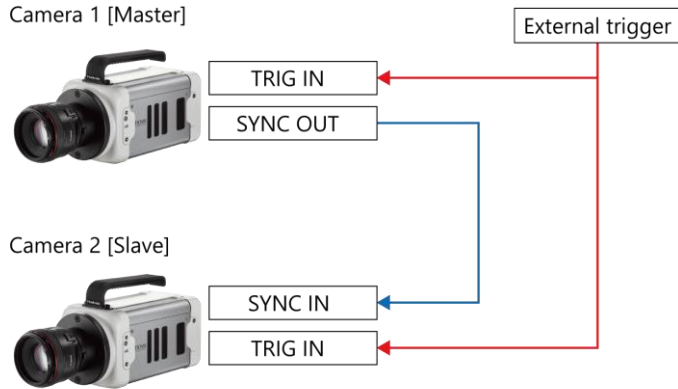

1. From among the cameras used for synchronized shots, choose a master camera (outputting a synchronization signal) and a slave camera (receiving the synchronization signal).
2. Connect master camera's SYNC OUT connector and slave camera's SYNC IN connector by using a cable.
3. Make the signal output setting of the master camera.
4. Make the signal input setting of the slave camera.
5. Input a trigger from outside to all the cameras.

#### NOTE

- In addition to the above settings, check “Do not input software trigger to slave cameras” from [MENU] - [Configuration] - [Trigger].
- If the communication is unstable or to set at your discretion, change the Ethernet settings referring the “3.1.4 Optimizing Ethernet Settings” on page 33.
- Connector names vary depending on your camera.
- Configure the I/O settings referring the “10.6.1 Setting External I/O Port” on page 310.

### 3.2.1. To Use Synchronization Signal from Outside for Synchronized Shots with Cameras

Here, the connection for synchronized shots by receiving a synchronization signal from an external device is described.

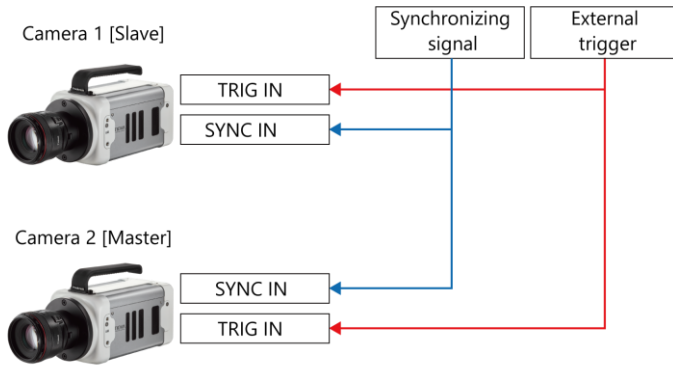

1. Connect the SYNC IN connector of each camera to connect and the synchronization signal generator by using a cable.
2. Make the “external input setting” of each camera to connect.
3. Input a trigger from outside to all the cameras.

### 3.2.2. To Use Two Gigabit Ethernet Interface Connectors Simultaneously

Here, in the camera equipped with two Gigabit Ethernet interfaces, the connection for using the two connectors simultaneously is described.

#### CAUTION

- In the camera equipped with two Gigabit Ethernet interface connectors, each of the connectors has its IP address. PC's IP address must be different from both the two addresses.
- In the network setting of PFV, specify only the IP address of “Gigabit Ether1 connector” by automatic search for IP address or IP address selection.  
If the IP addresses of both connectors are specified by IP address selection, two live images are displayed, preventing the high-speed communication with two interface connectors.

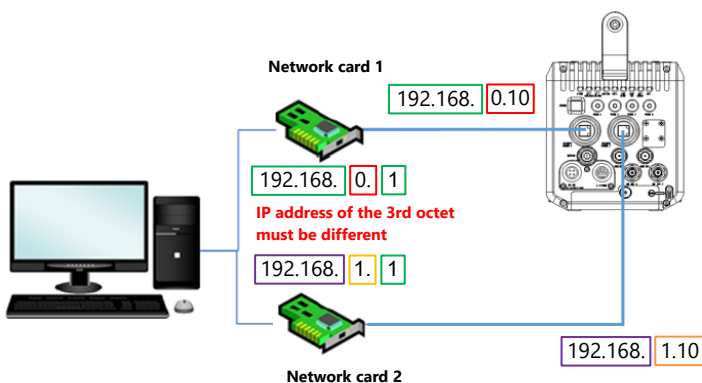

1. Set PC's IP address as shown in the left figure.
2. Insert two LAN cables into the Gigabit Ethernet interface connectors of the camera to connect it to the PC.
3. Turn on the camera.
4. Start PFV.

# 4

## Chapter 4 Camera Settings at Live Image

This chapter describes the camera settings necessary for recording.

## 4.1. Displaying/Editing Information

The upper-left part of the video display canvas displays the information based on each of LIVE, MEMORY, and FILE modes.

To hide this information, uncheck [Show info] in the upper part of the function panel.

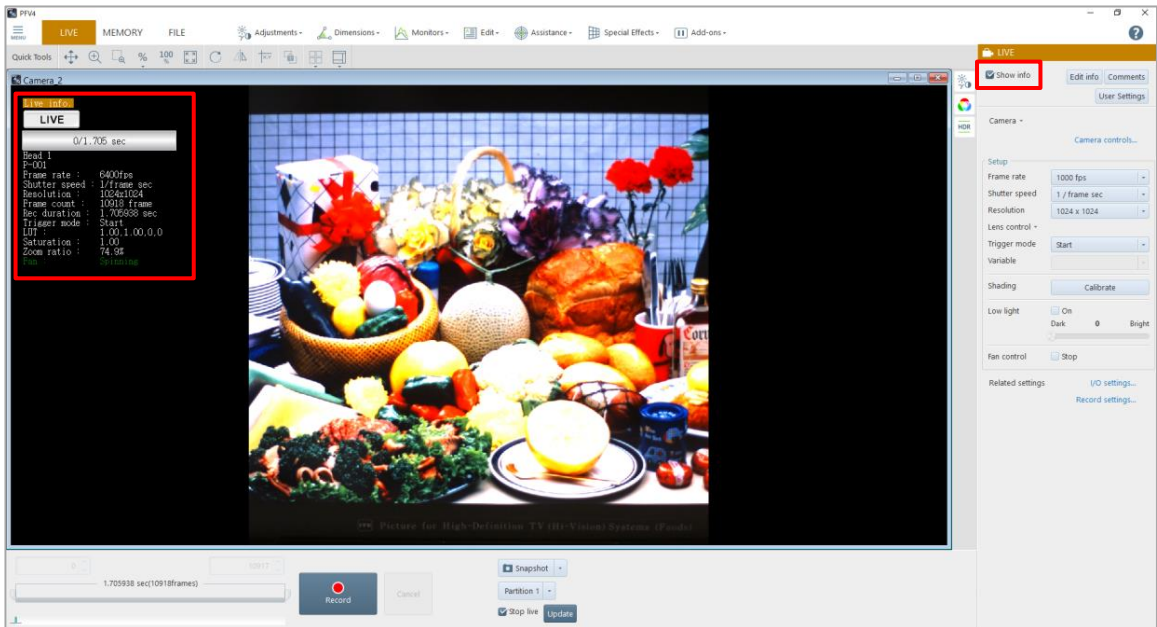



### 4.1.1. Warning Display

Warnings may appear in the LIVE mode. The types of warnings are “Acceleration Sensor Error”, “Initial Startup Error”, and “Device-related Warning”.



If any warning is displayed, see the “9.1.3 Export Support File” on page 290 to export a support file and contact our technical personnel.

## 4.1.2. Information Items

### ■ Camera state

Display	Description
	Live image being displayed.
	The camera is waiting to record.
	The camera is recording.

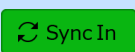
### ■ Sync signal input state

Display	Description
	No synchronization signal is being input to the camera.
	Synchronization signal is being input to the camera, regardless of whether it is possible to synchronize.
	Synchronization signal with a higher frequency than the once-synchronized signal is being input.
	Synchronization function not supported.



#### NOTE

For Mini CX 100, “Sync In” displays in the information display when a signal is input to the SYNC IN connector and is a valid synchronizable signal.

### 4.1.3. Editing Display Information

To customize items to display on the screen, click the [Edit info] button. The items to display can be rearranged by a drag-and-drop operation.

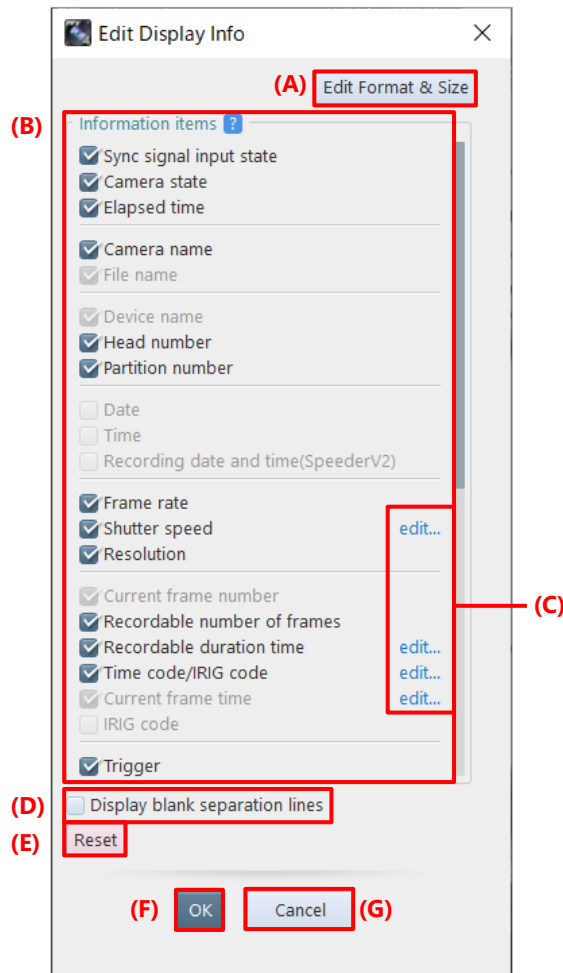

Item	Name	Function
(A)	Edit Format & Size	Displays a screen for setting the display format and icon size. For details, see “[Edit Format] screen” on page 49.
(B)	Information Items	Check items in this field to show/hide them. The items can be rearranged by a drag-and-drop operation.
(C)	edit	Displays the screen on which to edit display contents.
(D)	Display blank separation lines	Check here to insert blank separation lines among the items as per where the separation lines of “Information items” are.
(E)	Reset	Returns the settings to default.
(F)	OK	Applies the settings and closes this screen.
(G)	Cancel	Closes the screen without applying the changed settings.



## Information items

Items to be displayed in “Information items” on the “Edit Display Info” screen are as follows.

Items selected from “Information items” are displayed in the information display area of the view window.

- Sync signal input state
- Camera state
- Elapsed time
- Camera name
- File name
- Device name
- Head number
- Partition number
- Date
- Time
- Recording date and time
- Frame rate
- Shutter speed
- Resolution
- Current frame number
- Recordable number of frames
- Recordable duration time
- Time code/IRIG code
- Current frame time
- IRIG code
- Trigger
- H/W image trigger info
- Event marker
- Number of ignored triggers
- LUT
- Saturation
- Zoom ratio
- Cross cursor
- Comments
- Logo
- User settings
- Over sync alert
- Trigger to exposure gap time
- FAST Drive free space
- CFast card free space
- Fan state
- Measurements
- Battery information
- Acceleration sensor
- Lens Information

## [Comments] screen

This screen is displayed by clicking the [Comments] button or the [edit] button for [Comments] on the item list.

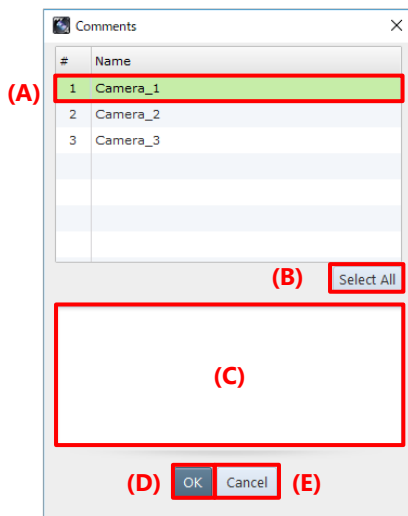

Item	Name	Function
(A)	Camera name	Click and select cameras for which to add comment.
(B)	Select all	Click the button to select all the cameras.
(C)	Comments	Enter a comment in text format.
(D)	OK	Applies the settings and closes this screen.
(E)	Cancel	Closes the screen without applying the changed settings.

## [User Settings] screen

This screen is displayed by clicking the [edit] button for [User settings] on the item list.

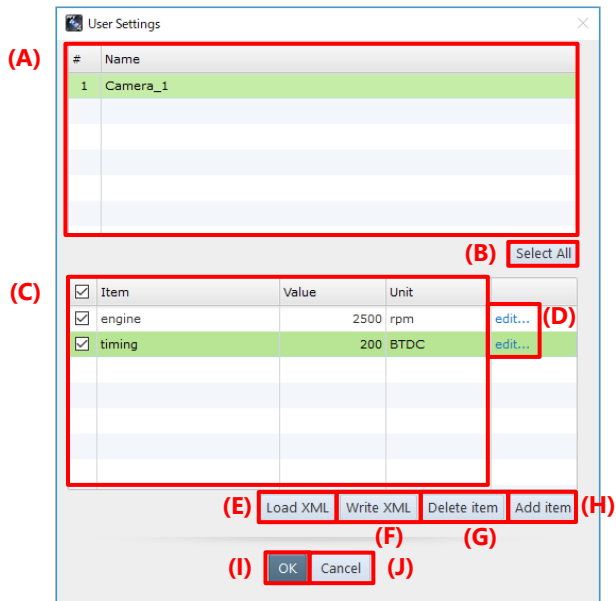

Item	Name	Function
(A)	Camera list	Click and select cameras for which to set the user settings.
(B)	Select All	Click the button to select all the cameras in the list.
(C)	Drawing selection	Check items to select them. Checking the box next to “Item” label selects all the items on the list.
(D)	edit	Click here to show the “Edit item” dialog. Edit items in this dialog.
(E)	Load XML	Clicking this loads an XML file that contains the user settings.
(F)	Write XML	Clicking this saves the user settings to an XML file.
(G)	Delete item	Deletes the checked items.
(H)	Add item	Click the button to show the “Add item” dialog. Fill each slot to add an item.
(I)	OK	Applies the settings and closes this screen.
(J)	Cancel	Closes the screen without applying the changed settings.

The following describes how to add or delete the user settings.

## ■ Adding an item

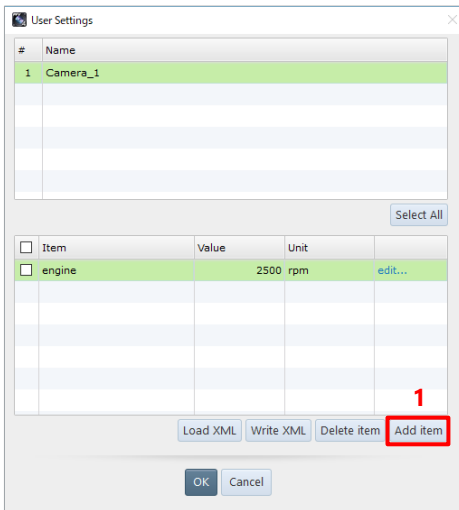

1. Click the [Add item] button.

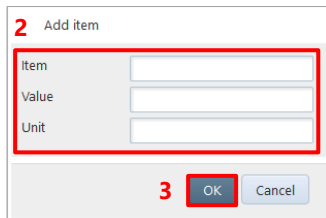

2. Fill each slot.
3. Click the [OK] button.

## ■ Editing an item

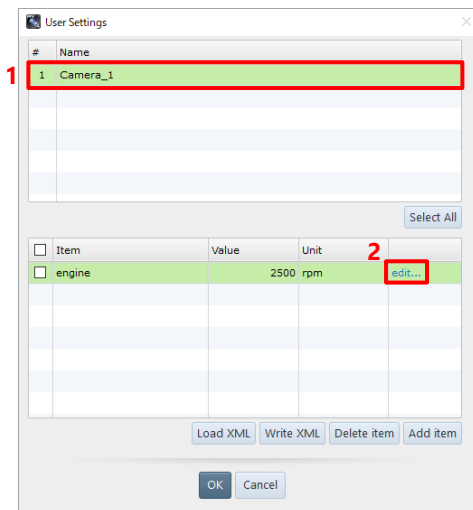

1. Select cameras to edit.
2. Click [edit] of the item.

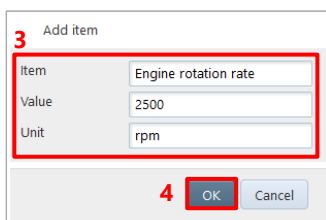

3. Change the information.
4. Click the [OK] button.

## ■ Deleting an item

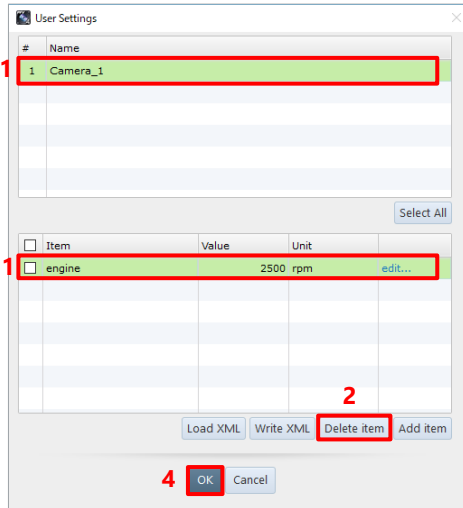

1. Select a camera and click items to delete.  
Multiple cameras are also selectable.
2. Click the [Delete item] button.  
The dialog asking you for confirmation of deletion appears.
3. Click the [Yes] button.
4. Click the [OK] button.

## ■ Saving the user settings

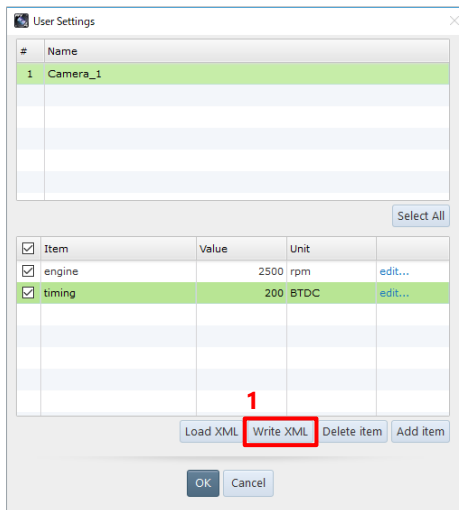

1. After making the user settings, click the [Write XML] button.  
The information which item is selected is also saved in an XML file.  
The “Save As” dialog appears.
2. Specify the destination and file name in the shown dialog, then click the [Save] button.

## ■ Importing the user settings

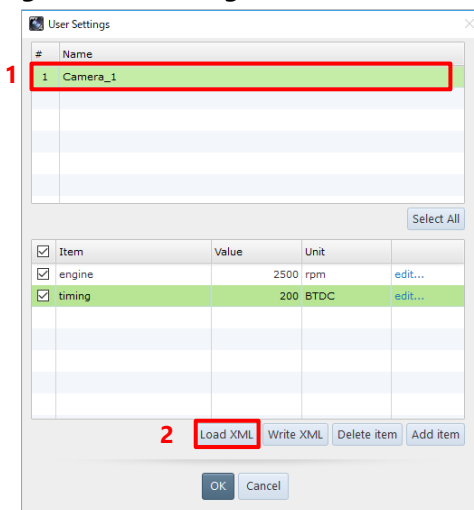

1. Click and select the camera to import its user settings.
2. Click the [Load XML] button.  
The [Open] dialog appears.
3. Enter the name of XML file to load.
4. Click the [Open] button.

## [Edit Format] screen

This screen is displayed by clicking [Edit Format & Size] on the screen to be displayed by clicking the [Edit info] button.

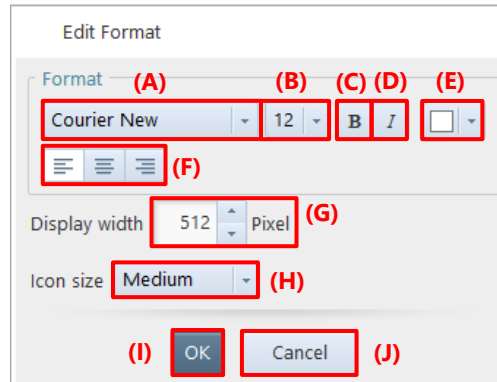

Item	Name	Function
(A)	Font selection	Select a font to use from the list to be displayed by clicking.
(B)	Font size	Select a font size to use from the list to be displayed by clicking.
(C)	Bold	Clicking this will put the font in bold.
(D)	Italic	Clicking this will put the font in italic.
(E)	Font color	Clicking this displays the screen on which to select a color, where you can select a color to use.
(F)	Alignment	Select a display width from among [L] (align left), [C] (align center), and [R] (align right).
(G)	Display width	Set the width of information display by entering a value.
(H)	Icon size	Select an icon size of “Camera state”, “Sync signal input state”, and “Elapsed time” from among [Large], [Medium], and [Small].
(I)	OK	Applies the settings and closes this screen.
(J)	Cancel	Closes the screen without applying the changed settings.



### NOTE



If characters are changed to bold or italic, the layout might be slightly collapsed.

## 4.2. Camera Controls Menu

Here, the setting of [Camera Controls] to be displayed on the function panel in LIVE mode is described.

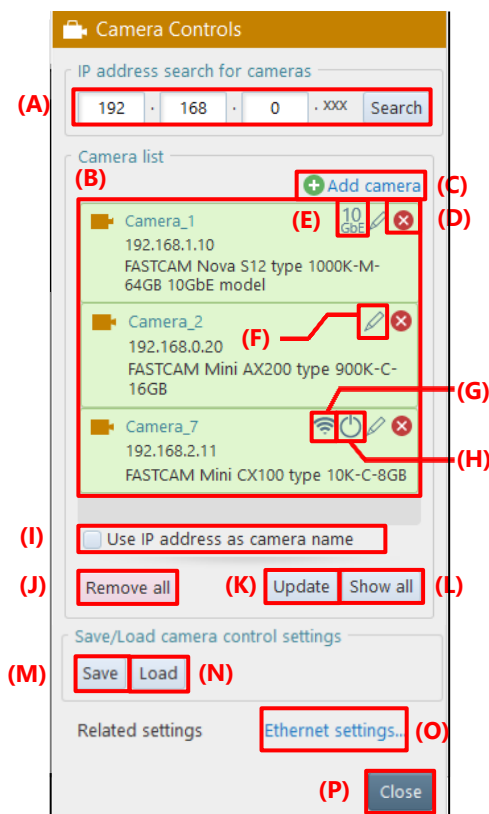
This screen is displayed by clicking [Camera controls] on the [LIVE] screen to be displayed on the function panel in LIVE mode.



Item	Name	Function
(A)	IP address search for cameras	Searches for a camera with its IP address. When you enter the IP address of a camera to search for and click the [Search] button, the applicable camera will be displayed on “Camera list”. For details, see “4.2.1 Searching for Camera” on page 52.
(B)	Camera list	According to the camera connection status, the head icon is displayed as follows.  : Connected  : Not connected
(C)	Add camera	Adds a camera to “Camera list”. For details, see “4.2.2 Registering Camera” on page 53.
(D)	Delete	Deletes the selected camera.
(E)	Link speed	If the selected camera has a 10GbE connection, “10GbE” will be displayed.
(F)	Edit	Change the name and IP address of the selected camera. For details, see “4.2.3 Changing Camera Name and IP Address” on page 54.
(G)	Wi-Fi connection	When connected to a Wi-Fi enabled camera, this icon will be active. Click the icon to display the Wi-Fi setting screen. The color of the icon will change to blue  when the camera is connected via Wi-Fi.

Item	Name	Function
(H)	Power off	When connected to a power controllable camera, this icon will be active. When this icon is clicked, a confirmation message will be displayed, and the camera power will be turned off or the camera will be rebooted. If two or more cameras that support power control from PFV are connected (including unselected cameras), a confirmation message will be displayed asking if you want to control them all at once.
(I)	Use IP address as camera name	Checking this displays the camera's IP address as a view window title (unchecking this displays the camera name). When the camera is connected by using a USB cable, the serial number is displayed.
(J)	Remove all	Deletes all the cameras.
(K)	Update	Refreshes all the camera connection statuses.
(L)	Show all	Selects all the cameras.
(M)	Save	Saves the current setting information. For details, see "4.2.4 Saving Setting Information" on page 55.
(N)	Load	Loads the saved setting information. For details, see "4.2.5 Loading Setting Information" on page 57.
(O)	Ethernet settings	Displays [Ethernet settings] window. For details, see "10.1.2 [Ethernet settings] Screen" on page 297.
(P)	Close	Closes [Camera Controls] and displays [LIVE].



## CAUTION

- If, with multiple cameras selected, even one camera not supporting a function to execute is included, the item of the applicable function may become inactive and disabled.
- The recorded data on camera memory disappears when the camera power is turned off. Be sure to download any necessary data after recording.



## NOTE

- This [Camera Controls] screen is displayed when LIVE mode starts if "Display camera control menu at startup" is selected in [Connection] on the [Configuration] screen. For details, see "10.1 Camera Connection Settings" on page 295.
- When multiple cameras are selected and values are set for them, if there is any camera not supporting the set values, the settings will be applied to the selected cameras except that camera. (However, if the maximum/minimum value not being supported by a camera is set, the closest value will be adopted.)

## 4.2.1. Searching for Camera

Set the IP address range to search for the camera not displayed on “Camera list”.

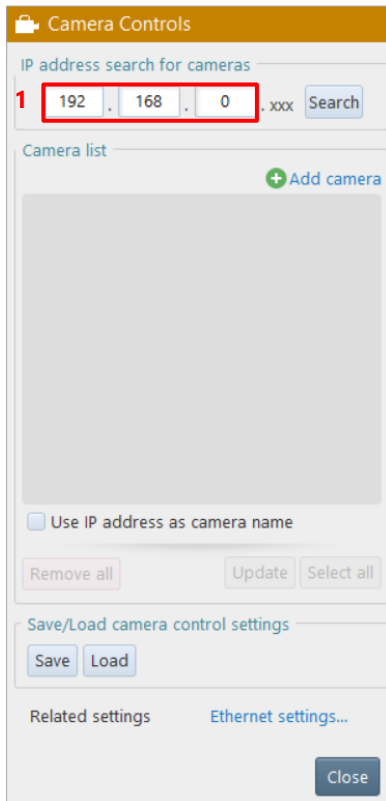

1. Set the IP address range.

When the high-order octet of the IP address is specified in “IP address search for cameras”, addresses existing in the network are searched for automatically and displayed on “Camera list”.

If a target camera is not displayed on “Camera list”, check the connection of the camera and click the [Search] button to search for it again.

If a target camera is displayed on “Camera list” but with a “?” mark, check the connection with the camera and click the [Update] button to search for it again.



### CAUTION

When using a hub and connecting cameras to the hub additionally, it may take about one minute for the newly connected camera to become searchable.



### NOTE

- Clicking the [Update] button refreshes the connection statuses of the cameras displayed on “Camera list”.
- For USB connection, regardless of the IP address range, cameras are searched and displayed if they are not displayed in the list.



## 4.2.2. Registering Camera

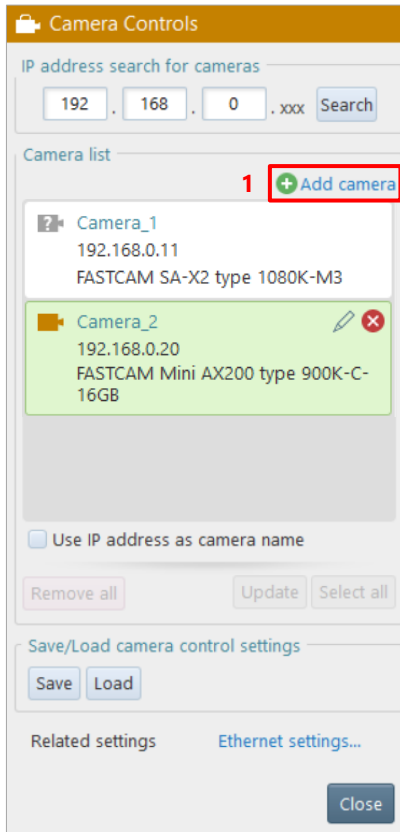

1. Click [Add camera].  
The “Add camera” dialog is displayed.

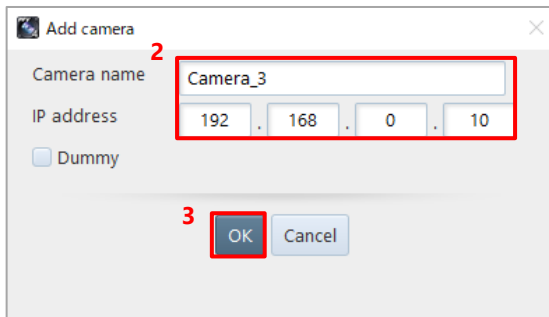

2. Enter the camera name and its IP address.  
To add it as a dummy camera, check [Dummy].
3. Click the [OK] button.  
The newly added camera is displayed on “Camera list”.

### NOTE

When [Dummy] is checked, you can only enter the 4th octet of IP address.

## 4.2.3. Changing Camera Name and IP Address

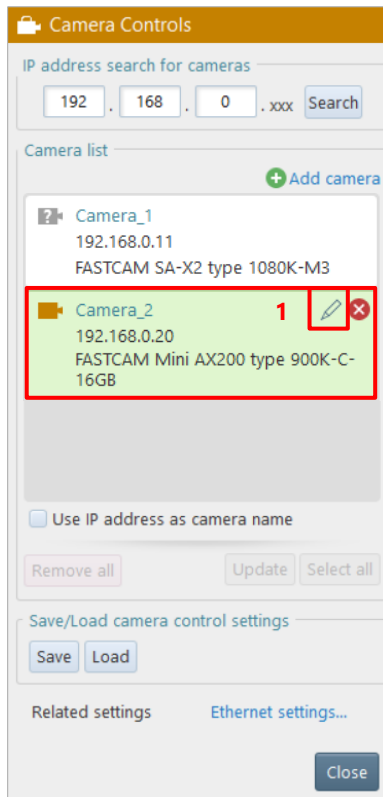

1. Select a camera.  
Click the camera to change from “Camera list” and click the [Edit] button displayed in the upper-right part. The “Edit Camera Info” dialog is displayed.

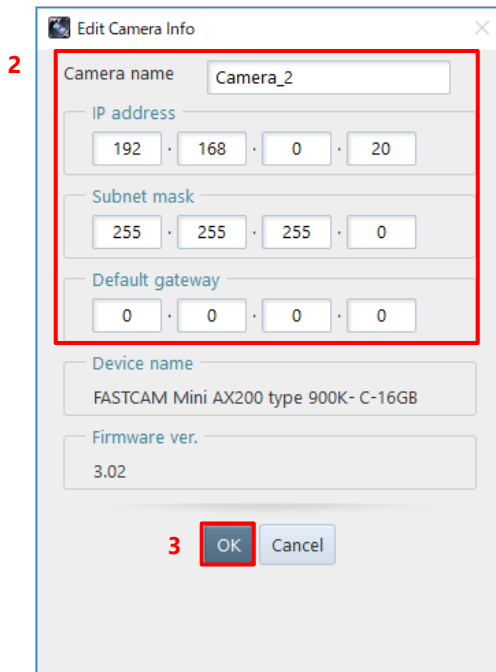

2. Change values.  
Change the following values as necessary.
  - Camera name:  
Camera name to change
  - IP address:  
IP address of camera to change
  - Subnet mask:  
Subnet mask of camera to change
  - Default gateway:  
Default gateway setting of camera to change. Most often left blank.
3. Click the [OK] button.  
The settings are changed.  
The settings will be applied after the camera is restarted.

## 4.2.4. Saving Setting Information

Save the current settings in [DEVICE SETTINGS]. You can specify one of the following as the destination.

- Saving to the PC: Saves the setting information of all the cameras to the PC.
- Saving to the preset region of the camera: To the preset region of the connected camera, saves the setting information of the applicable camera.

### NOTE

If you check the [Execute “Save to camera” of camera settings] under [MENU] - [Configuration] - [Connection], the settings will be preset saved to the camera when the connection between the PFV and the camera is disconnected. For details, see “10.1 Camera Connection Settings” on page 295.

### ■ To save to the PC

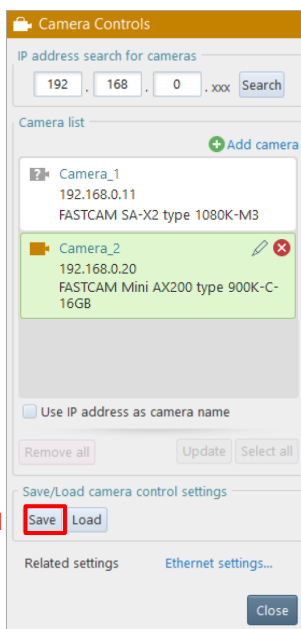

1. Click the [Save] button.  
The “Save Camera Control Settings” dialog is displayed.

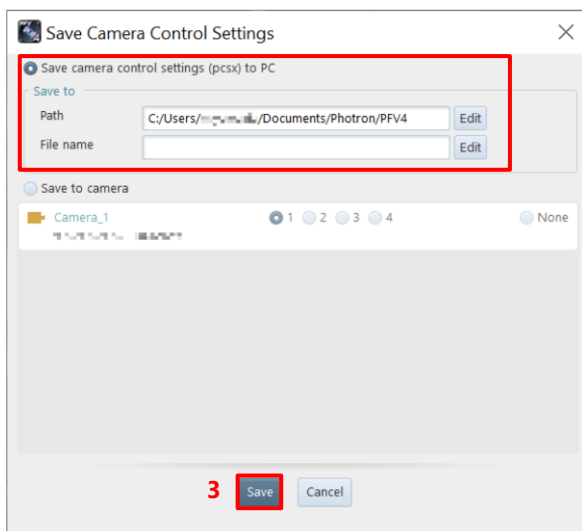

2. Specify the destination and the filename.
3. Click the [Save] button.  
The current setting information file is saved to the PC.

## ■ To save to the preset region of the camera

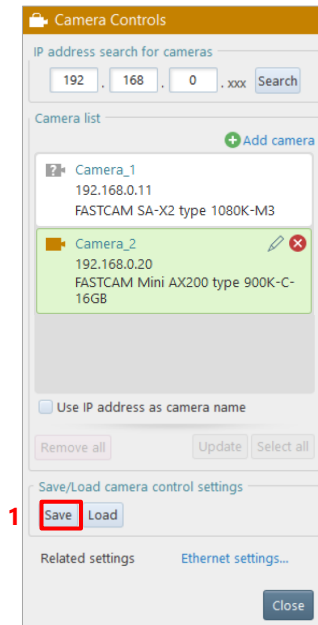

1. Click the [Save] button.  
The “Save Camera Control Settings” dialog is displayed.

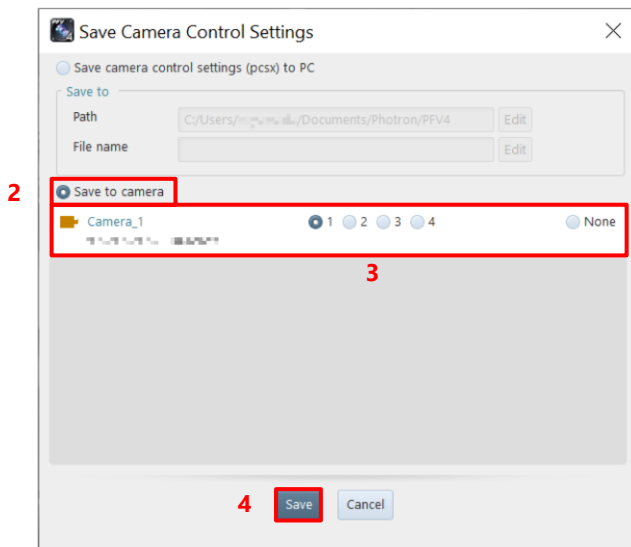

2. Check [Save to camera].  
The list of the connected cameras is displayed in the lower part of the dialog.
3. Choose the preset region of destination for each camera.  
Choose [None] for the camera whose information is not saved.
4. Click the [OK] button in the lower part of the dialog.  
The current setting information is saved to the preset region of the camera.

## 4.2.5. Loading Setting Information

Load the setting information saved in “4.2.4 Saving Setting Information” on page 55.  
You can specify one of the following as the source.

- Setting information saved on the PC
- Setting information saved in the preset region of the camera

### ■ To load the setting information saved on the PC

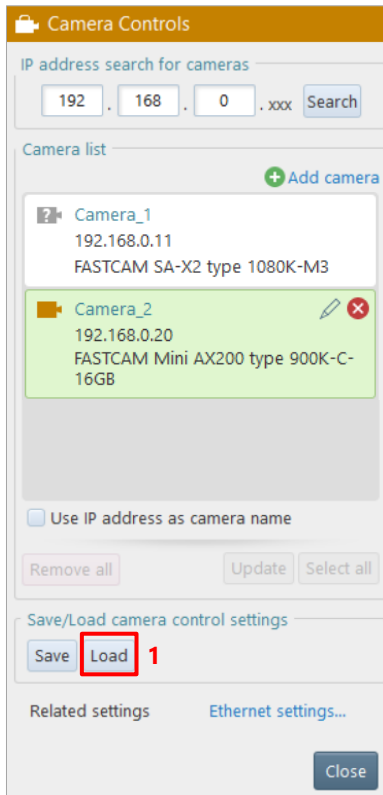

1. Click the [Load] button.  
The “Load Camera Control Settings” dialog is displayed.

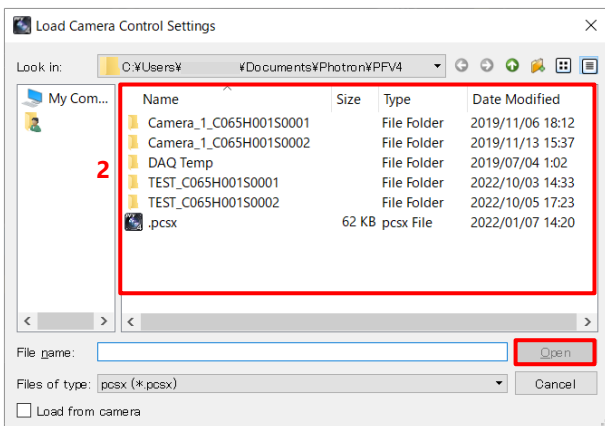

2. Specify the source filename.
3. Click the [Open] button.  
The current setting information is changed to that in the loaded file.

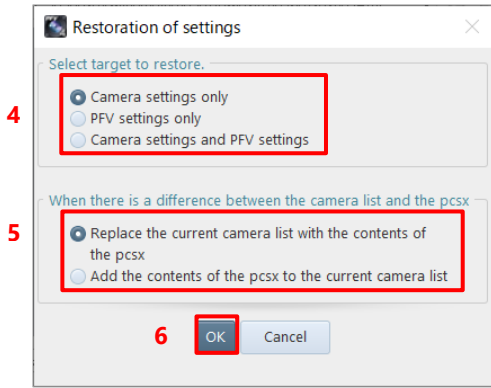

The [Restoration of settings] window appears.

4. Check the settings to load and click the [OK] button.
5. Select the settings to be used when there is a difference between the camera list and the pcsx file.
6. Click the [OK] button.
7. Loads and restores the selected settings.
8. Click the [OK] button to close the window.

The window differs according to the settings to restore.

PFV restarts as needed.

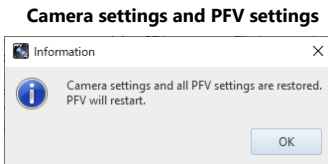
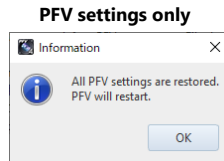
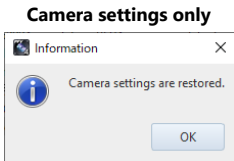

## NOTE

- In saving or loading a pcsx file, most of the settings of the camera inside and the PFV4 are restored. Contact our technical personnel for detailed items.
- If the camera cannot be connected and cannot be restored, or if a camera with the same IP but a different model is found, a warning message will be displayed because the camera settings cannot be restored.

■ To load the setting information saved in the preset region of the camera

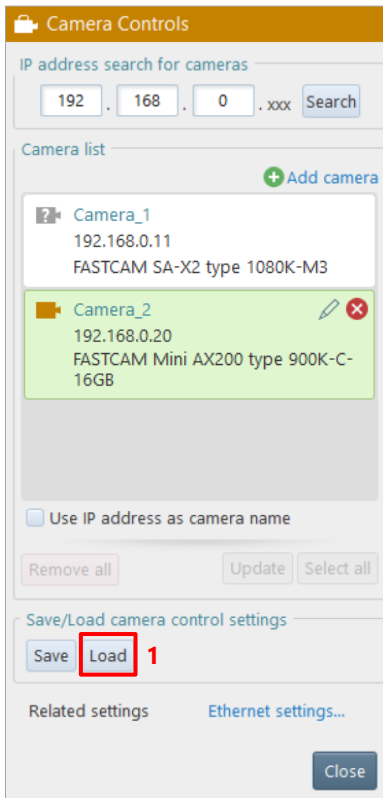

1. Click the [Load] button.  
The “Load Camera Control Settings” dialog is displayed.

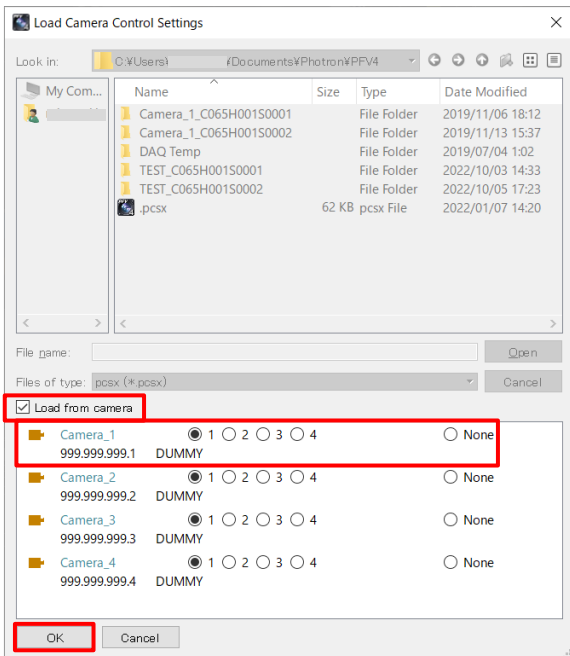

2. Check [Load from camera].  
The list of the connected cameras is displayed in the lower part of the dialog.
3. Choose the preset region of source for each camera.  
Choose [None] for the camera to load no setting information from.
4. Click the [OK] button in the lower part of the dialog.  
The current setting information is changed to that loaded from the camera.

## 4.3. Setting Shooting Conditions

Here, the setting of [LIVE] to be displayed on the function panel in LIVE mode is described.

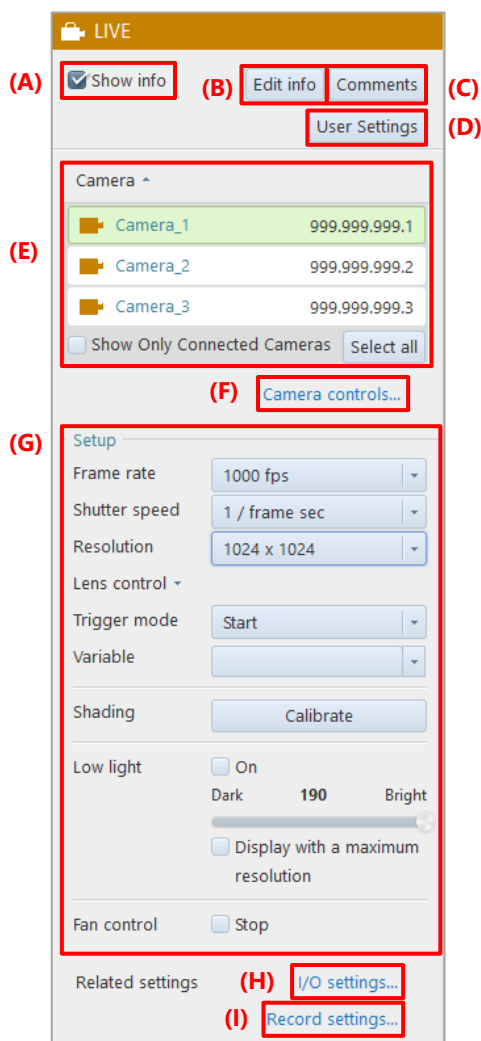

Item	Name	Function
(A)	Show info	Checking this displays the information set by using the information editing function on the video canvas.
(B)	Edit info	Clicking this item allows you to select the information to display. For details, see “4.1 Displaying/Editing Information” on page 42.
(C)	Comments	Clicking this item allows you to enter a comment for the camera. For details, see “[Comments] screen” on page 45.
(D)	User settings	Clicking this item allows you to add information to be displayed at the upper left of the view window. For details, see “[User Settings] screen” on page 46.
(E)	Camera	This is to show cameras for the current devices. Click [▼] to list cameras which can be specified as the current devices. Select cameras to show. Click [Show Only Connected Cameras] to show only the connected cameras. Click [Show all] to show all the cameras. The selected cameras will be highlighted.



Item	Name	Function
(F)	Camera controls	Clicking this displays the [Camera Controls] screen. For details, see “4.2 Camera Controls Menu” on page 50.
(G)	Setup	For details, see “4.3.1 Items in “Setup” on page 62.
(H)	I/O settings	Clicking this item displays the [I/O settings] screen. For details, see “10.6 I/O Settings” on page 308.
(I)	Record settings	Clicking this item displays the [Record settings] screen. For details, see “10.4 Recording Setting” on page 302.



**NOTE**

Selecting multiple cameras by mouse  
 Include the cameras to select within the dotted rectangle as shown below.

Good

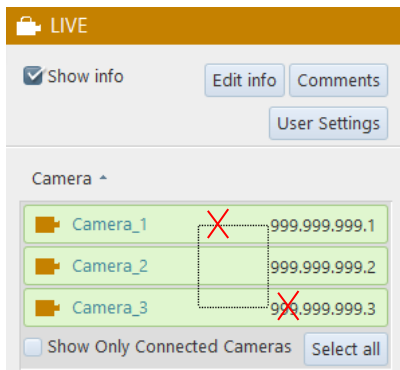

Bad

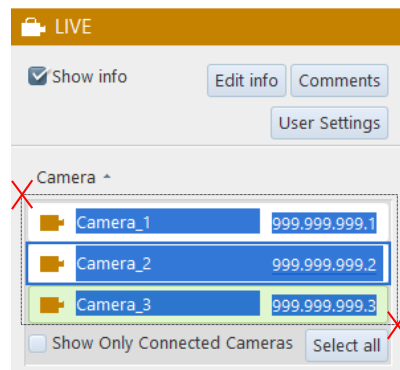

## 4.3.1. Items in "Setup"

Here, the settings in "Setup" on the [LIVE] screen to be displayed on the function panel in LIVE mode are described. Settings, such as lists, displayed in this item vary with the camera model.

The screenshot shows the 'Setup' menu in the LIVE interface. Items (A) through (M) are highlighted with red boxes. Item (G) is further detailed in a separate panel on the right.

**(G) Manual Trigger**

Trigger mode: Manual

Trigger parameters ^

Total frames: 43684

Trigger point: [Slider]

	Before trigger	After trigger
frame	10921	32763
%	25.00	75.00

**Random/Random Reset Trigger**

Trigger mode: Random

Trigger parameters ^

Frames per trigger: 1

Record count

Record count limit: 1

**RandomManual Trigger**

Trigger mode: Random Manual

Trigger parameters ^

Frames per trigger: 999

Record count limit: 6



Trigger point: [Slider]



	Before trigger	After trigger
frame	333	666
%	33.33	66.67

Item	Name	Function
(A)	Frame rate	Clicking this displays the list of frame rates that can be set for the selected camera. Select a frame rate to set from this list.

**NOTE**

- When the frame rate is changed, the resolution and shutter speed values and the selectable ranges will be changed in synchronization.
- In variable mode, the variable frame rate is displayed. When the frame rate is changed by reselecting it, the variable mode will be canceled.

Item	Name	Function
(B)	Shutter speed	<p>Clicking this displays the list of shutter speeds that can be set for the selected camera. Select a shutter speed to use from this list.</p> <p>For the shutter speed, priority is given to the setting for a frame rate. Therefore, when you set the frame rate after setting the shutter speed, it will automatically be set to default (shutter release).</p> <p>You can choose the shutter lock, automatic exposure control setting, and dual slope shutter, as long as the camera to use supports them.</p>
(C)	Dual slope shutter	<p>Set the extended dynamic range mode. When you choose [Dual slope shutter] in [Shutter speed], the menu to set an exposure interval rate will be displayed. Set the exposure interval rate here by using the slider or entering a value.</p> <p>The value 0 means that the extended dynamic range mode is off.</p> <p>When only the characters “Dual slope shutter” are displayed, you can display the exposure interval rate setting menu by clicking [▼] to the right of the characters.</p> <p>For details, see “4.3.4 Detailed Settings of Shutter Speed” on page 68</p>
(D)	Resolution	<p>Clicking this displays the list of resolutions that can be set for the selected camera. Select a resolution to set from this list.</p> <div data-bbox="504 691 1284 969" style="border: 1px solid orange; padding: 10px;"> <p> <b>NOTE</b></p> <ul style="list-style-type: none"> <li>• When the camera to use supports resolution lock, the item of “Resolution lock” is displayed on the list. For the resolution lock, see “4.3.3 Resolution Lock” on page 67.</li> <li>• In variable mode, the variable resolution is displayed. When the resolution is changed by reselecting it, the variable mode will be canceled.</li> </ul> </div>
(E)	Lens control	<p>When the camera supports remote control, the EF mount lens and the Micro Four Thirds mount lens can be controlled remotely from PFV. The lens types and the controllable functions are as follows. Use the slider of each function for setting.</p> <ul style="list-style-type: none"> <li>- EF mount lens: IRIS, Focus</li> <li>- Micro Four Thirds mount lens: IRIS, Focus, Zoom</li> </ul> <p>Use the slider of each function for setting.</p> <div data-bbox="504 1213 1284 1503" style="border: 1px solid yellow; padding: 10px;"> <p> <b>CAUTION</b></p> <ul style="list-style-type: none"> <li>• The control is available only when a controllable lens is mounted.</li> <li>• If the lens is changed after PFV is started, PFV needs restarting.</li> <li>• The zoom-in function of the quick toolbar and the zoom function of the lens control are not synchronous.</li> <li>• They are different because the lens control uses an analog zoom method, and the quick toolbar uses a digital zoom method for zooming in/out.</li> </ul> </div>
(F)	Trigger mode	<p>Select a trigger mode from the list to be displayed by clicking. Setting the trigger mode to a shooting target is convenient when you check and analyze recorded images. In addition, when the selected camera supports a hardware image trigger, “H/W image trigger” is displayed on the list.</p> <p>For details, see “4.4 Setting Trigger Mode” on page 77.</p>

Item	Name	Function
(G)	Trigger parameters	<p>The menu will differ depending on the trigger selected in (F).</p> <ul style="list-style-type: none"> <li>• Total frames: Displays the total number of frames that can be recorded.</li> <li>• Trigger point: Sets the ratio of recording frames before and after trigger input. More detailed settings can be made before and after trigger.</li> <li>• Frames per trigger: Sets the number of frames per trigger input.</li> <li>• Record count: This is displayed when Random or Random Reset trigger is selected. Check this box to set the maximum number of recordings.</li> <li>• Record count limit: Sets the maximum number of recordings for Random triggers.</li> <li>• Before trigger (frame): Sets the number of frames until the trigger is input. Click on the icon to turn it on and off.</li> <li>• After trigger (frame): Sets the number of frames after the trigger is input. Click on the icon to turn it on and off.</li> <li>• Before trigger (%): Sets the ratio of frames before the trigger is input. Click on the icon to turn it on and off.</li> <li>• After trigger (%): Sets the ratio of frames after the trigger is input. Click on the icon to turn it on and off.</li> </ul> <p> <b>NOTE</b></p> <ul style="list-style-type: none"> <li>• “Random triggers” is a generic term for Random, Random Reset, Random Center, Random Manual, and Random Loop triggers.</li> <li>• With variable mode, the resolution being selected will be displayed.</li> </ul>
(H)	Variable	<p>In [Frame rate] or [Resolution], to select a setting that is not on the list to be displayed by clicking the corresponding button, you can use it by choosing [Variable] and then registering the desired values as a channel. For details, see “4.3.6 Detailed Settings of Variables” on page 74.</p>
(I)	Shading	<p>Allows you to make a shading (black level) correction of the image sensor. Making the shading correction resets the black-level non-uniformity in pixels in the image sensor.</p>
(J)	Low light	<p>Lightens a LIVE mode display screen by reducing the frame rate temporarily. It is useful for such a case where, because of high-speed image shooting, the LIVE mode display screen is so dark until shooting is executed that the lens focus cannot be adjusted easily, under the set shooting conditions. Checking [On] enables the brightness adjusting slider, where you can adjust it. In addition, when you operate the slider, the shutter speed of the camera will be changed in synchronization. After the adjustment, uncheck [On] to turn off the low light. When you turn on the low light, the resolution before it is turned on will be saved, the maximum resolution will be used instead, and the pre-change resolution will be displayed on the video display region in rectangle form. This rectangular range is fixed. When you turn off the low light, the rectangular display will disappear. If you check the “Display with a maximum resolution” checkbox, the frame rate will be set to the lowest value and the resolution will be displayed at the maximum value.</p> <p> <b>CAUTION</b></p> <p>The range of the shutter speed that can be set varies between on and off of the low light.</p>

Item	Name	Function
(K)	Camera communication reset	Clicking the [Camera communication reset] button executes phase adjustment (reconfiguration of camera communication) for all selected cameras that have a phase adjustment warning. This button is displayed only when ST Camera Head is connected.
(L)	Fan control	Checking [Stop] can stop the fans for a certain period. The fan can be stopped while the temperature does not affect the camera.
(M)	LED/laser control	<p data-bbox="477 336 1292 369">Enables and disables LED and the positioning laser pointer individually.</p> <div data-bbox="491 394 1284 614" style="border: 1px solid orange; padding: 10px;"> <p data-bbox="495 401 636 446"> <b>NOTE</b></p> <ul data-bbox="526 471 1236 606" style="list-style-type: none"> <li data-bbox="526 471 1236 529">• This feature is only enabled when the FASTCAM Multi LED option is used.</li> <li data-bbox="526 537 1236 569">• Connect the LED light option before starting the camera.</li> <li data-bbox="526 577 1236 606">• For details, see the FASTCAM_Multi_LED_HW_Manual.</li> </ul> </div>

### 4.3.2. Lock Function in Trigger Parameter

When the recordable total frames change due to changes in the frame rate of the camera or the number of partitions, the trigger position will also be changed. By locking the parameters, the trigger position setting is retained.

e.g., When locking the Before trigger (%) and changing the frame rate

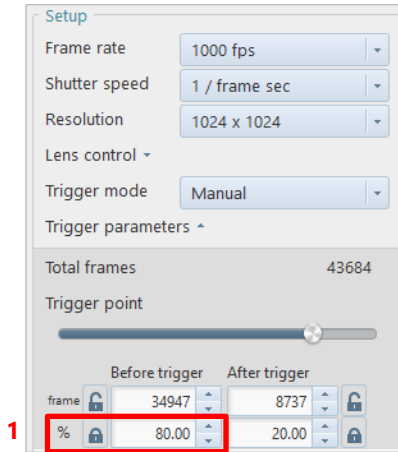

1. Set the Before trigger (%) and click on the padlock symbol to lock it.

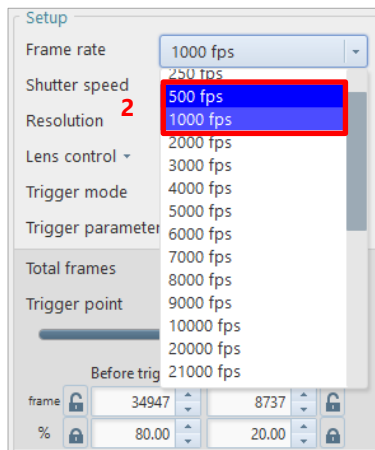

2. Change the frame rate.

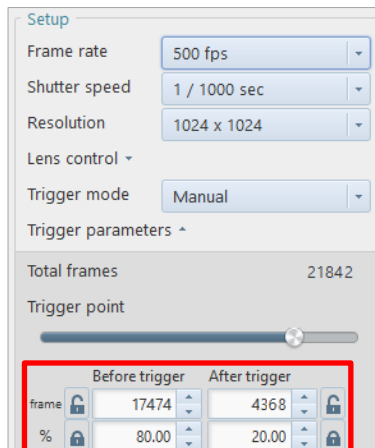

The Before trigger frames is automatically set to the value 17474 (21,842 x 80%) based on the locked parameter (for percentage)

### 4.3.3. Resolution Lock

---

The resolution lock is a function to maintain a resolution without automatically changing it even if a frame rate is changed.

When the camera to use supports the resolution lock, the item of “Resolution lock” is displayed on the resolution list. Clicking it turns on/off the resolution lock.

When the resolution lock is on, the background of “Resolution lock” turns green.



#### NOTE

If you have changed the resolution lock setting when multiple cameras are connected and all the cameras are shown, it makes same lock setting as that of the current camera to the other cameras as well. However, it does not change the setting for cameras not supporting the resolution lock.

## 4.3.4. Detailed Settings of Shutter Speed

You can choose the shutter lock, automatic exposure control setting, and dual slope shutter from the shutter speed list, if the camera to use supports them. Here, those items are described.

### ■ Shutter lock

The shutter lock is a function to maintain a shutter speed without automatically changing it even if a frame rate is changed. When the camera to use supports the shutter lock, “Shutter lock” is displayed on the list to be displayed by clicking [Shutter speed]. Clicking it turns on/off the shutter lock. When the shutter lock is on, the background of “Shutter lock” turns green.

#### NOTE

If you have changed the shutter lock setting when multiple cameras are connected and all the cameras are shown, it makes same lock setting as that of the current camera to the other cameras as well. However, it does not change the setting for cameras not supporting the shutter lock.

### ■ Dual slope shutter

The dual slope shutter is a function to extend the dynamic range of the camera when filming events that have areas of pixel saturation by having a shorter exposure for bright areas of the image a longer exposure for darker areas of the image.

When the camera to use supports the dual slope shutter, “Dual slope shutter” is displayed on the list to be displayed by clicking [Shutter speed].

When you choose [Dual slope shutter], the slider bar and numeral field where you set an exposure interval rate will be displayed.

Set the exposure interval rate by using the slider bar or entering a value.

#### CAUTION

When the camera is set in the following state, the dual slope shutter cannot be set.

- The trigger mode is set at [Random reset].
- The automatic exposure control is ON.

The exposure interval rate is set by using the slider or entering a value.

#### NOTE

- The setting and unit range from 0 % to 95 % in 5 % increments.  
However, for the following camera models, they range from 0 % to 99 %.
  - SA-Z    • WX50    • WX100    • AX50    • AX100    • AX200    • Nova
- If you have changed the dual slope shutter setting when multiple cameras are connected and all the cameras are shown, it makes same setting as that of the current camera to the other cameras as well. However, it does not change the setting for cameras not supporting the dual slope shutter.
- To use the Dual slope shutter function on Nova R3 / R5, go to [MENU]-[Configuration]-[Camera Option] and check the “Enable” checkbox under the “Dual slope shutter”, and reboot the camera.



## ■ Automatic exposure control setting

When the automatic exposure control function (Auto exposure) is used, in addition to the shutter speed value initially set, the shutter speed can automatically be changed according to the amount of entering light to maintain the desired image illumination level. Use this function in situations where the subject's light will likely change. When the camera to use supports the automatic exposure control, the “Auto exposure Settings” screen is displayed. Choosing [Auto exposure] displays the “Auto Exposure Settings” screen. In addition, the [LIVE] screen displays the target range setting rectangle.



### CAUTION

When the camera is set in the following state, the automatic exposure control cannot be set.

- The dual slope shutter is ON.
- The low light mode is ON.



### NOTE

- When multiple cameras are connected and [All cameras] is also selected on the device list, [Auto exposure] is disabled.
- If the resolution is changed after configuring Auto exposure settings, Auto exposure settings need to be set again.

Here, the “Auto Exposure Settings” screen is described.

The screenshot shows the 'Auto Exposure Settings' screen with the following labeled components:

- (A)  Auto exposure
- (B) Area: W: 128 × H: 8
- (C) Position: X: 192 Y: 256
- (D) Target value: 128
- (E) Range: 13
- (F) Max exposure: 1 / 1000 sec
- (G)  Show histogram
- (I) [OK] [Cancel] [Apply]
- (H) [OK] button
- (J) [Apply] button

Item	Name	Function
(A)	Auto exposure	Checking this enables the automatic exposure control function.
(B)	Area	Specify the width and height of the reference image area for shutter speed setting. The image area can also be set by dragging the video display area. In this case, you cannot set the area exceeding the current resolution. The set area is displayed on the live image view window in dotted frame form. The shutter speed is changed so that the average level for the image in the image area specified here will be the desired image output level (within the range of “Value ± Range”).
		<b>CAUTION</b> For SA2 and SA6, you cannot specify the area exceeding 1M pixel (“1,024 x 1,024” etc.) within the range of full resolution (2,048 x 2,048).

Item	Name	Function
(C)	Position	Specify the X-coordinate and Y-coordinate of the target image area for automatic exposure control judgment. The minimum coordinates are not (0, 0) but the upper-left coordinates in the current resolution based on the maximum resolution. You can also operate the rectangular selected range with a mouse.
(D)	Target value	Specify the reference image output level for automatic exposure control judgment.
(E)	Range	Enter the allowable range for the image output level ("Target value").
(F)	Max exposure	Set the maximum exposure time. This can be set to prevent subject blur resulting from a too long exposure time. A shutter operation with an exposure time longer than the shutter value set here will not be performed.
(G)	Show histogram	Checking this displays the histogram of the specified range.
(H)	OK	Applies the settings to the camera and closes this setting screen.
(I)	Cancel	Closes the screen without applying the changed settings.
(J)	Apply	Applies the settings to the camera.

### ■ Relationship among settings

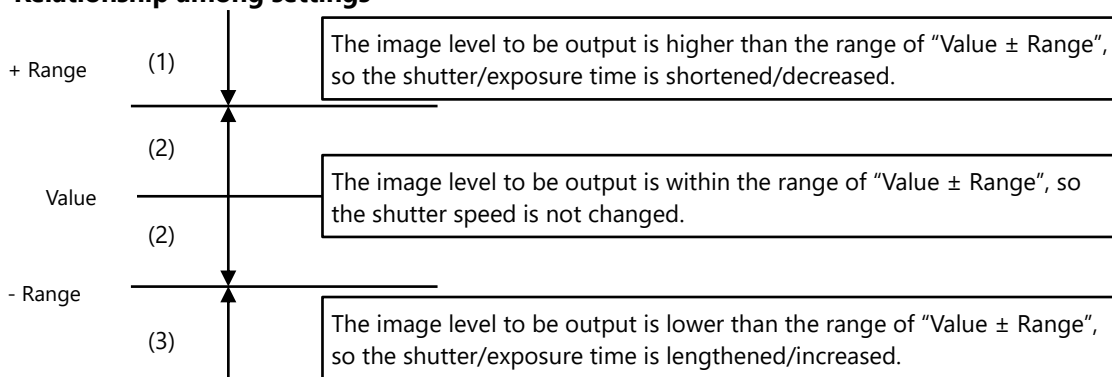

## 4.3.5. Lens Control

When the camera supports remote control in LIVE mode, the EF mount lens and the Micro Four Thirds mount lens can be controlled remotely from PFV. The lens types and the controllable functions are as follows. Use the slider of each function for setting.

Lens Type	IRIS	Focus	Zoom	Close Lens
EF mount lens	✓	✓		
Micro Four Thirds mount lens	✓	✓	✓	✓



### CAUTION

- If the lens is changed after PFV is started, PFV needs restarting.
- The lens must be closed during storage.



### NOTE

- This function is available only when a controllable lens is mounted.
- The zoom-in function of the quick toolbar and the zoom function of the lens control are not synchronous. They are different because the lens control uses an analog zoom method, and the quick toolbar uses a digital zoom method for zooming in/out.

The screenshot shows the PFV LIVE interface with the following lens control settings highlighted:

- (A)** Camera selection: Camera\_3, μFourThirds
- (B)** Iris (F-number): Open 10 Close
- (C)** Focus (m): Near 355 Far
- (D)** Focus mode: Auto
- (E)** Zoom (mm): W 23 T
- (F)** Reset button
- (G)** Close lens button

Item	Name	Function
(A)	Lens name	Displays the lens name.
(B)	Iris	<p>Every time you click the [Close] button, the Iris will be adjusted to be closed.</p> <p>Every time you click the [Open] button, the Iris will be adjusted to be opened.</p> <p>The current value is displayed in the field between the [Close] and [Open] buttons.</p> <p>You can adjust it by clicking the up/down buttons of this field.</p> <p>You can also use the slider bar to set the Iris value.</p> <p>Move the slider bar towards the [Open] button to make the image lighter, and [Close] to darker.</p>
(C)	Focus	<p>Every time you click the [Near] button, the focus will be made near.</p> <p>Every time you click the [Far] button, the focus will be made far.</p> <p>The current value is displayed in the field between the [Near] and [Far] buttons.</p> <p>You can adjust it by clicking the up/down buttons of this field.</p> <p>You can also use the slider bar to set the focus.</p> <p>Move the slider bar towards the [Far] button to bring a distant object into focus, and [Near] to bring a near object into focus.</p>
(D)	Auto	<p>This button will be activated when a camera that supports the auto focus function is connected. Click the [Auto] button to perform auto focus adjustment.</p> <p>For details, see the “Automatic focus setting” on page 73.</p>
(E)	Zoom	<p>Every time you click the [W] button, the image will be zoomed out.</p> <p>Every time you click the [T] button, the image will be zoomed in.</p> <p>The current value is displayed in the field between the [W] and [T] buttons. You can adjust it by clicking the up/down buttons of this field.</p> <p>You can also use the slider bar to set the zoom.</p> <p>Move the slider bar towards the [T] button to zoom in, and [W] to zoom out.</p>
(F)	Reset	<p>Clicking this resets the parameters when mounting an EF lens or a Micro Four Thirds mount lens after starting PFV.</p>
(G)	Close lens	<p>Clicking this ends the lens control, allowing you to remove the lens. It is displayed only when the Micro Four Thirds mount lens is mounted.</p>

## ■ Automatic focus setting

When an EF mount lens is attached to the Nova, the [Auto] button will appear. Click the [Auto] button to display the settings screen.

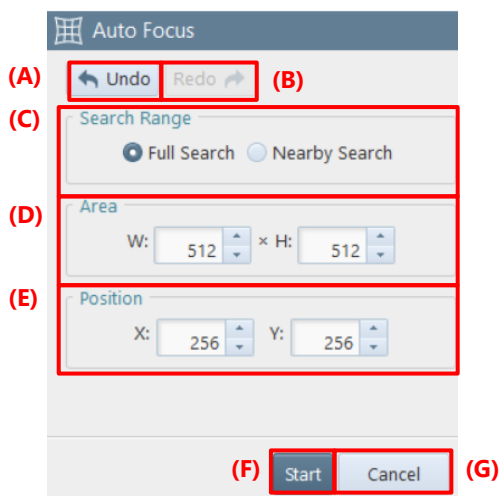

Item	Name	Function
(A)	Undo	Undoes the previous action.
(B)	Redo	Redoes the undone action.
(C)	Search Range	Select the range to adjust the auto focus. It can also be select from PFV4 Mobile. <ul style="list-style-type: none"> <li>• Full Search: Adjusts the focus from the entire focus range.</li> <li>• Nearby Search: Adjusts the focus from around the focus setting when automatic adjustment is started.</li> </ul>
(D)	Area	Specify the width and height of the area to be focused on. Specify the range by entering a numerical value or by dragging the frame that appears.
(E)	Position	Specify the X-coordinate and Y-coordinate of the area to be focused on. You can also move the frame by dragging that appears.
(F)	Start	Start the auto focus adjustment. When the adjustment is completed, a confirmation message will appear. Click the [Yes] to apply the focus setting or click the [No] if you do not want to apply the focus setting.
(G)	Cancel	Closes the screen without applying the changed settings.

### 4.3.6. Detailed Settings of Variables

For the FASTCAM-series cameras that support variables, if you want to use the settings that do not exist in the list displayed by clicking [Frame rate] and [Resolution] in “Camera” on the function panel in LIVE mode, select [Variable] to specify and register desired values as a channel. You can register up to 20 custom frame rate/resolution channels. The mode for which the frame rate and resolution are specified is called “Variable mode”. To use the registered settings, click [Frame rate] and [Resolution] and then select the channel registered in [Variable] from the displayed list, or click [Variable] and select the channel.

#### NOTE

When multiple cameras are connected, select one of them and then execute this function.

#### ■ Registering channels and starting variable mode

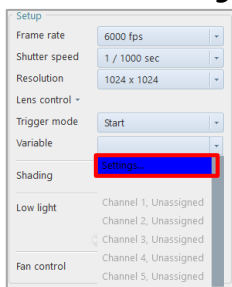

1. Click [Settings] on the variable list.

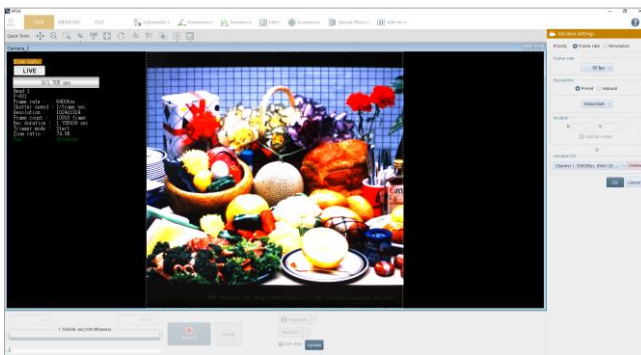

The “Variable settings” screen is displayed, and the resolution setting range is displayed in the center of the live image.

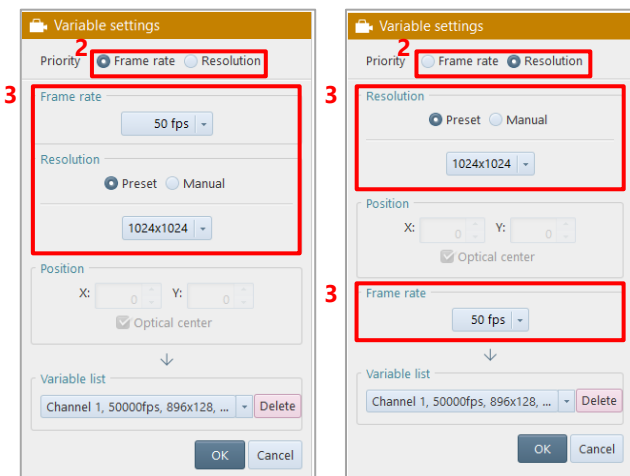

2. Choose the item to be given priority, from [Frame rate] / [Resolution] in “Priority” on the “Variable settings” screen. The contents of the “Variable settings” screen change according to the selected item.
3. Set the frame rate and the resolution. When [Frame rate] is chosen in the step 2, set in the order from [Frame rate] to [Resolution], meanwhile when [Resolution] is chosen in the step 2, set in the order from [Resolution] to [Frame rate]. In the setting of “Resolution”, choose between [Preset] and [Manual].

## NOTE

You can make the original setting where “W (width)” and “H (height)” are specified by choosing [Manual] in [Resolution] or dragging the white frame indicating the image area displayed in the video display area. (However, for some models, it cannot be made depending on the combination with a frame rate.)

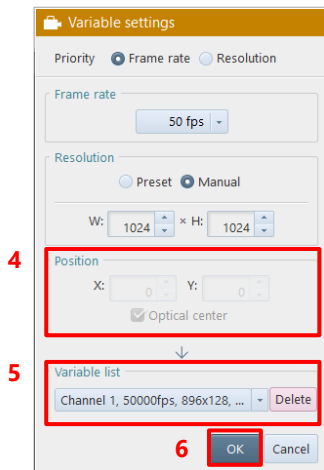

4. For the camera where a shooting position can be specified, specify “Position”. To set the position at the optical axis center, check [Optical center].
5. From “Variable list”, select a target channel for registration.
6. Click the [OK] button. The settings are registered in the channel and the variable mode starts.

### ■ Deleting variable channel

When you select a target channel and click the [Delete] button on the “Variable settings” screen, settings in the selected channel will be deleted.

### ■ Canceling variable mode

When you select the desired frame rate from [Frame rate] on [LIVE], the variable mode will be canceled.

### ■ Setting variable mode + desired resolution

Whether the variable mode will be canceled when you select the desired resolution from [Resolution] on [LIVE] depends on the camera model. Whether the variable mode is established can be checked from a channel in [Variable] on [LIVE]. (When the channel number is between 1 and 20, the variable mode is established. Otherwise, it is canceled.)

If the resolution currently displayed in “Resolution” is different from that of the channel currently selected in “Variable”, both the variable mode and the desired resolution is set.

## 4.3.7. Shading Calibration

Allows you to make a shading (black level) correction of the image sensor.  
Making the shading correction resets the black-level non-uniformity in pixels in the image sensor.

### NOTE

There is no need to block light for a camera mounted with a mechanical shutter.  
To check whether your camera has a mechanical shutter, see the “1.2 Features Supported by Each Camera” on page 14.

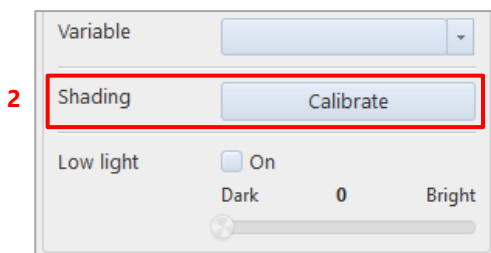

1. Shade the image sensor completely using the lens cap, etc.
2. Click the [Calibrate] button in the function panel.  
Black level image is recorded to the camera and shading correction is executed.

### NOTE

- For a more precise recording, it is recommended to calibrate each time after changing frame rate, shutter speed, or resolution.
- In such cases below, the noise may be removed by the shading correction.
  - Fixed noise of horizontal streaks appears.
  - Noise across the image except a part appears.
- If you use PFV4.0.6.0 or later with Nova series or MH6, shading data and other correction data is stored to your PC.
- For models that can store correction data to the camera (SA series such as SA-Z and SA-X2), save from [Function panel] - [Camera controls] - [Save/Load camera control settings] - [Save] or [MENU] - [Configuration] - [Image Quality] - [Shading Settings] - [Save to camera].  
To automatically store the shading correction data to the camera when shading, go to [MENU] - [Configuration] - [Image Quality] - [Shading settings], and check to “Auto save shading calibration data”.
- When using a camera with a mechanical shutter, if the following items in [Configuration] - [Image Quality] are checked, shading correction will be automatically executed after changing the setting.
  - Auto shading calibration (only for cameras with mechanical shutter)
  - Auto shading calibration when going into Ready state (only for cameras with mechanical shutter)
- If external synchronization is enabled, a warning message will appear if no synchronization signal is input. Disable external synchronization temporarily or input a synchronization signal before performing shading.



## 4.4. Setting Trigger Mode

### 4.4.1. What Is Trigger Mode?

Setting the trigger mode to a shooting target is convenient when you check and analyze recorded images.

The timing and number of frames to be recorded on the camera when a trigger signal is input vary with the set trigger mode. For details, refer to the timing diagram in the hardware manual for each model.

- Relationship diagram of frames to be recorded and trigger modes

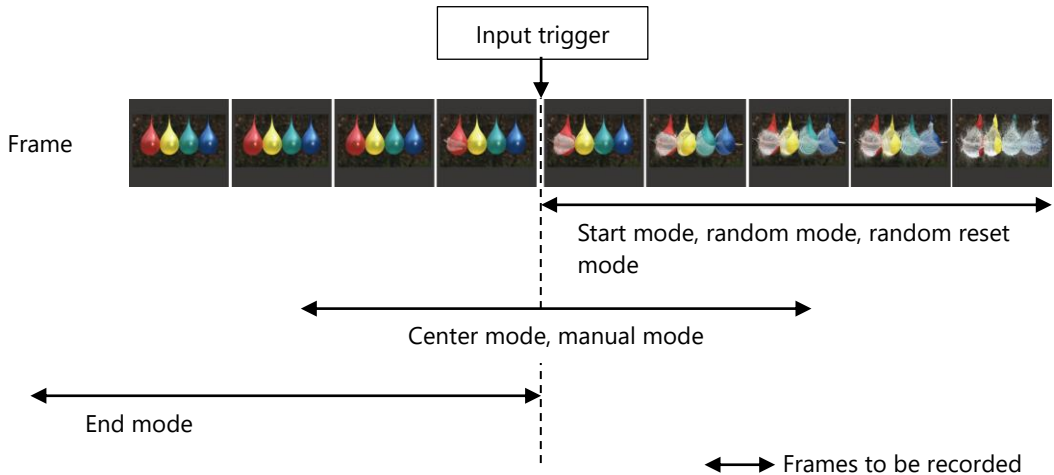



- Button used for recording

Use the [Record] button on the recording/playback panel to start recording.

The [Record] button name and color change according to the status. The button name indicates the current status.

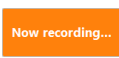

Button Used	Description
	Clicking this makes the system enter the recording ready state. (For the trigger mode to make an endless recording, the endless recording is started.)
	Clicking this inputs a trigger. Recording in the specified trigger mode starts at the time when the trigger is input. Trigger is input in the order of IP address when multiple cameras are connected.
	Indicates the recording state after the trigger is input. In this state, nothing happens even if it is clicked.

- **Endless recording**

In recording the images right before a trigger signal is input (recording in center mode, manual mode, and end mode), the endless recording is made.

Data will be overwritten if exceeding the memory capacity.

Example of camera that can record four frames



Frames to be recorded in memory

Start of endless recording

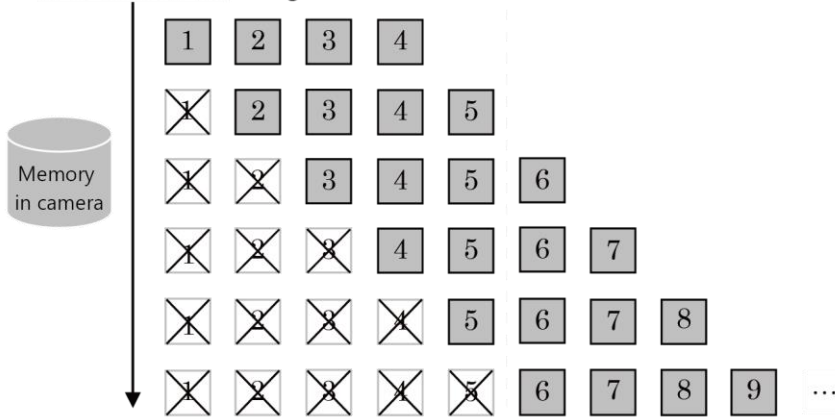

When the memory capacity is exceeded, old frames are overwritten and new frames are recorded.

⊗ Frames to be overwritten

Frames to be recorded eventually after trigger signal input

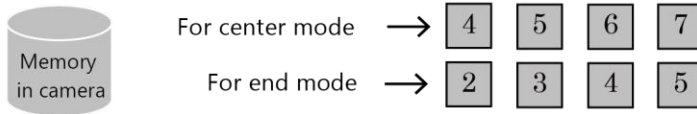

## 4.4.2. Supported Trigger Modes by Camera

Camera \ Trigger	Start	Center	End	Manual	Random	Random Center	Random Manual	Random Reset	Random Loop	REC ON CMD
Nova S6-S20	✓	✓	✓	✓	✓		✓	✓		
Nova R2-R5	✓	✓	✓	✓	✓		✓	✓		
MH6	✓	✓	✓	✓	✓	✓	✓			
Mini R5				✓			✓	✓		
Mini AX50/100/200	✓	✓	✓	✓	✓		✓	✓		✓
Mini UX50/100	✓	✓	✓	✓	✓					
Mini WX50/100	✓	✓	✓	✓	✓			✓		
Mini CX		✓	✓	✓						
SA-X2	✓	✓	✓	✓	✓	✓	✓	✓	✓	✓
SA-Z	✓	✓	✓	✓	✓	✓	✓	✓	✓	✓
Multi	✓	✓	✓	✓	✓	✓	✓	✓		
SA1.1/SA4/SA5	✓	✓	✓	✓	✓	✓	✓	✓		
MH4	✓	✓	✓	✓	✓					
MC2.1	✓	✓	✓	✓	✓					
SA2/SA6	✓	✓	✓	✓	✓	✓	✓	✓		
SA3	✓	✓	✓	✓	✓			✓		
SA7/SA8	✓	✓	✓	✓						



### CAUTION

When using Random Center or Random Manual trigger, it may not be possible to select them depending on the camera settings.

- SA-Z: IRIG setting is ON, or Auto Exposure setting is ON, and the number of recording frame is less than 64.
- SA-X2: IRIG setting is ON, and the number of recording frame is less than 32.

### 4.4.3. Trigger Mode Types

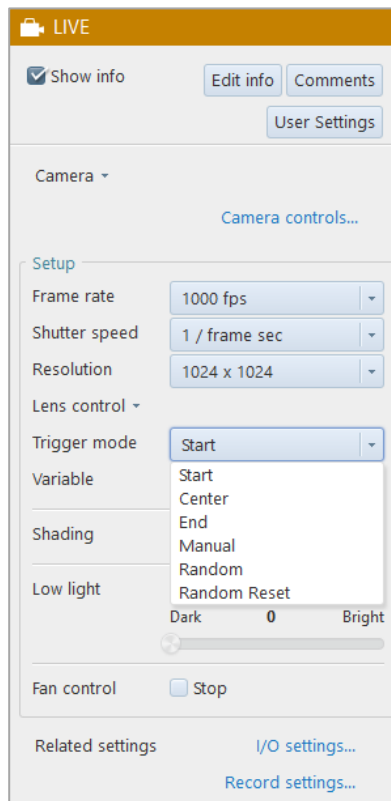

#### CAUTION

Some modes are not displayed depending on the camera model.

#### ■ Start mode

Recording starts at the time of trigger input. This mode is suitable for recording a high-speed phenomenon where the event's start point is known in advance.

Recording will continue until the maximum recordable frame count (camera memory capacity) is reached. In other words, it will end when the camera memory capacity is used up.

Example: For the camera that can make a recording for 2 seconds (2,000 frames) in total  
 Right after the [Ready] button is clicked, 2 seconds of high-speed images will be recorded.

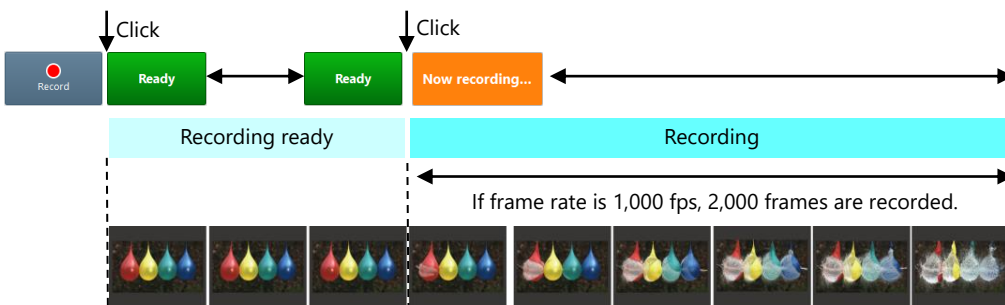



## NOTE

For shooting in the “Start mode”, the first frame to be recorded varies with the camera model.

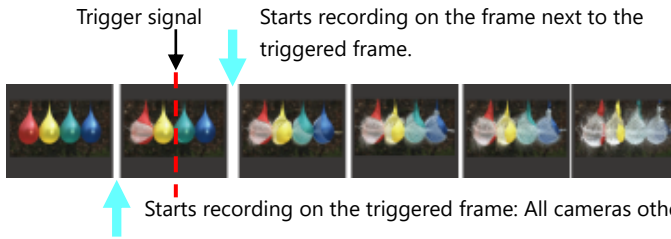

Mini AX 200, Mini AX 100, Mini AX 50, Mini WX 100, Mini WX 50, Multi, SA-Z, SA-X2, Mini UX 100, Mini UX 50, SA8, SA7, Nova, and MH6

## ■ Center mode

Images right before and after trigger input are recorded. This mode is suitable for recording before and after an important moment.

Recording will continue until the maximum recordable frame count (camera memory capacity) is reached. The frame count before and after the trigger is equal.

Clicking the [Record] button indicates the button as [Ready], making the system enter the endless recording state.

Clicking the [Ready] button indicates the button as [Now recording], using the remaining half of the camera memory capacity for recording.

Example: For the camera that can make a recording for 2 seconds (2,000 frames) in total

After the [Ready] button is clicked, 1 second of images will be recorded. Then, clicking the [Ready] button indicates the button as [Recording], recording the remaining 1 second of images. In total, 2 seconds of high-speed images will be recorded.

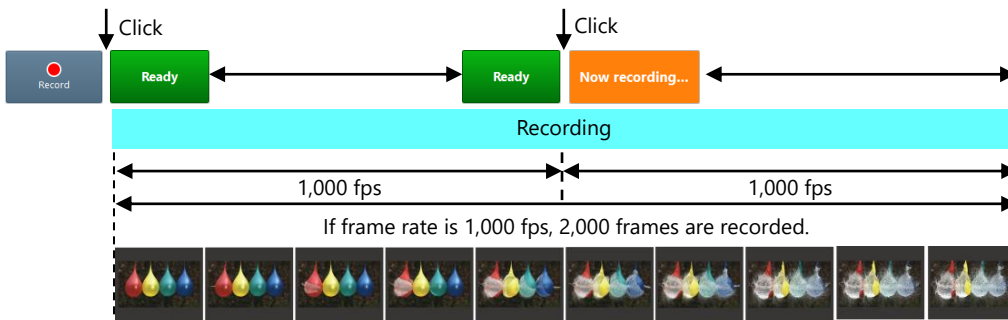

## ■ End mode

Images right before trigger input are recorded.

This mode is suitable for recording an important phenomenon for which it is difficult to predict when the event will begin and end.

Clicking the [Record] button indicates the button as [Ready], making the system enter the endless recording state.

Clicking the [Ready] button again ends the recording.

Example: For the camera that can make a recording for 2 seconds (2,000 frames) in total

Clicking the [Record] button puts the camera into an Endless Recording loop.

Clicking the [Ready] button again ends it, capturing the previous 2 seconds of images.



## Manual mode

As with the center mode, images right before and after trigger input are recorded.

In the center mode, the proportion of recording before and after trigger input is equal; in the manual mode, however, you can set the desired proportion of recording (number of seconds etc.) before and after the important moment to record.

Example: When, with the camera that can make a recording for 2 seconds (2,000 frames) in total, 0.5 (500 frames) and 1.5 seconds (1,500 frames) are set respectively for recording before and after the event.

Clicking the [Record] button starts the endless recording. Clicking the [Ready] button indicates the button as [Now recording], recording 2 seconds of high-speed images in total: 0.5 and 1.5 seconds respectively before and after the Ready button is clicked.

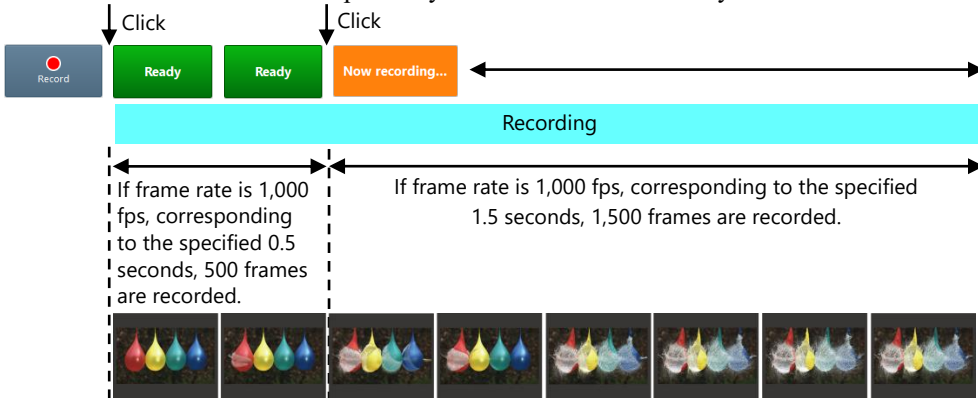

Settings for the recording in manual mode are as follows.

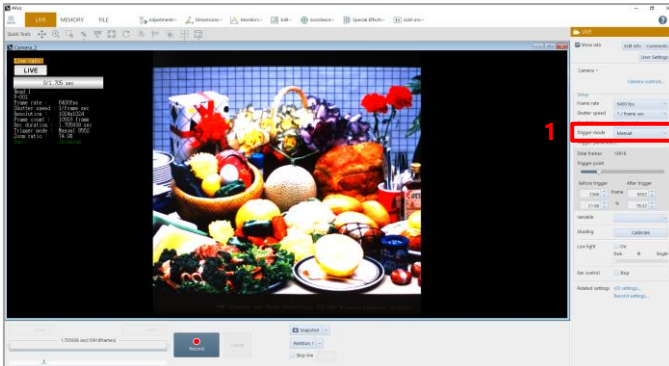

1. Choose [Manual] from the list to be displayed by clicking [Trigger mode]. Setting items corresponding to the manual mode are displayed.

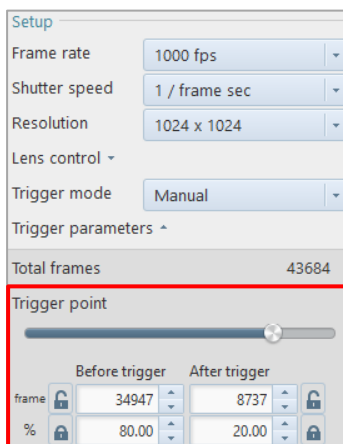

2. Set the number of frames to record before and after trigger input.
  - Drag the slider bar of [Trigger point].
  - Enter the frame count for [Before trigger] and [After trigger].
  - Enter the proportion of the frame count for [Before trigger] and [After trigger].

## ■ Setting manual mode

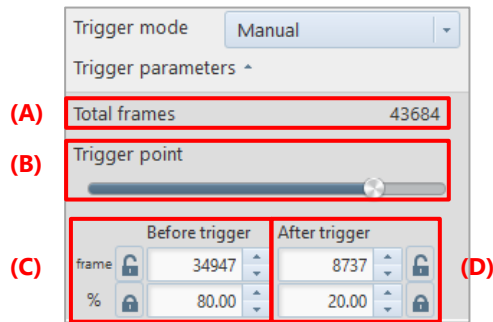

Item	Name	Function
(A)	Total frames	The total frame count available to shooting is displayed.
(B)	Trigger point	Use one of the following methods to specify the number of frames to record before and after trigger input. <ul style="list-style-type: none"> <li>• Drag the slider bar of [Trigger point].</li> <li>• Enter the frame count for [Before trigger] and [After trigger].</li> <li>• Enter the proportion of the frame count for [Before trigger] and [After trigger].</li> </ul> For the lock function, refer to the “4.3.2 Lock Function in Trigger Parameter” on page 66.
(C)	Before trigger	
(D)	After trigger	



## ■ Random mode

Every time a trigger is input, only a preset number of frames right after trigger input will be recorded.

This mode is suitable for a phenomenon that happens irregularly.

The recordable frame count for one trigger input can be set freely from 1 frame to the maximum recordable frame count, in 1 frame increments.

Example: When the number of recording frames is set at 1,000

Right after the [Now recording...] button is clicked, the specified frame count of high-speed images will be recorded.

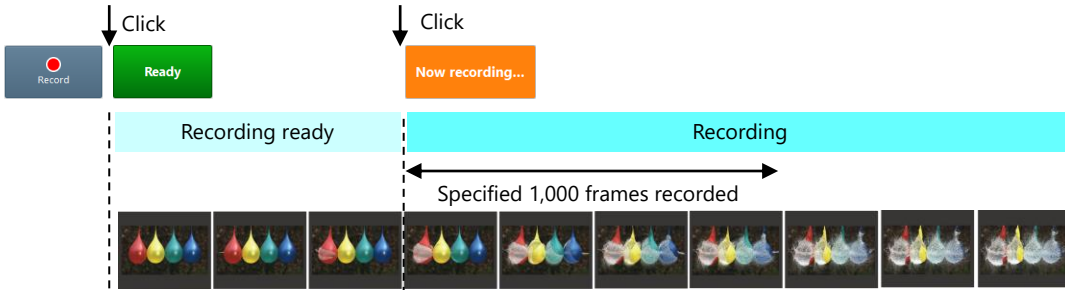

Settings for the recording in random mode are as follows.

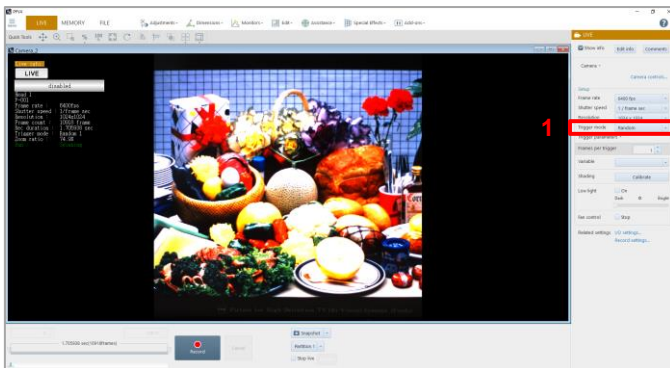

1. Choose [Random] from the list to be displayed by clicking [Trigger mode]. Setting items corresponding to the random mode are displayed.

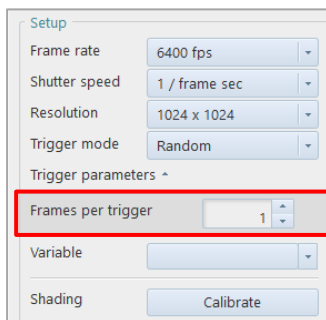

2. Set the number of frames to record for every trigger input, on the random mode setting screen to be displayed. For details of the setting, see “Setting random mode” on page 86.

## ■ Setting random mode

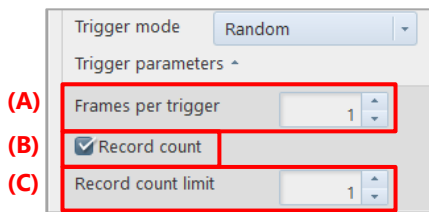

Item	Name	Function
(A)	Frames per trigger	Set the number of frames to record for every trigger input.
(B)	Record count	Check this to specify the maximum recording count for random triggers. If it is not checked, triggers can be input until the end of recording by the frame count available to shooting.
(C)	Record count limit	Set the maximum number of triggers to apply. It can be set between 1 and the maximum number of times set for each camera, or such that [Record count] by [Record count limit] does not exceed the frame count available to shooting.

### NOTE

For shooting in the “Random mode”, the first frame to be recorded varies with the camera model.



Mini AX 200, Mini AX 100, Mini AX 50,  
Mini WX 100, Mini WX 50, Multi, SA-Z,  
SA-X2, Mini UX 100, Mini UX 50, SA8,  
SA7, Nova, and MH6

## ■ Random center mode

As with the random mode, every time a trigger is input, a preset number of frames will be recorded.

In the random mode, a specified number of frames right after trigger input are recorded; in the random center mode, however, a specified number of frames before and after trigger input are recorded.

This mode is suitable for a continuous phenomenon that happens irregularly. You can apply a trigger for its every critical timing and check the phenomenon before and after trigger input.

The recordable frame count for one trigger input can be set freely from 1 frame to the maximum recordable frame count, in 1 frame increments.

Example: When, with the camera that can make a recording for 2 seconds (2,000 frames) in total, the number of recording frames is set at 500 (1,000 fps, maximum number of triggers: 2)

After the [Ready] button is clicked, the recording loop state will be established, recording 500 frames of high-speed images before and after the click of the [Now recording...] button.

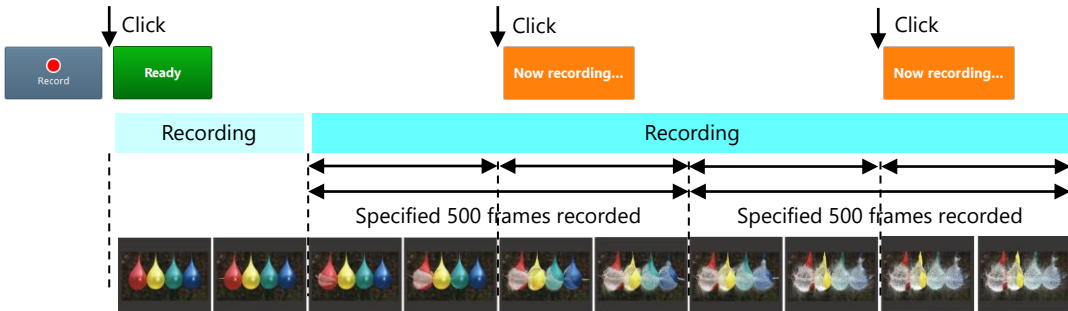

Before recording images in the random center mode, you need to make the following settings.

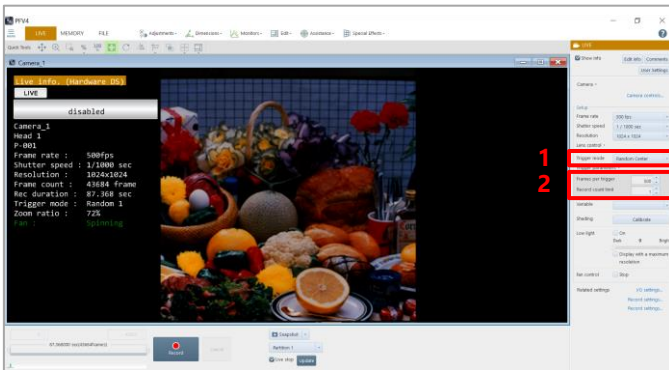

1. Choose [Random center] from the list to be displayed by clicking [Trigger mode]. Setting items corresponding to the random center mode are displayed.
2. Make the settings.  
For details of the settings, see “Setting random center mode” on page 88.

## ■ Setting random center mode

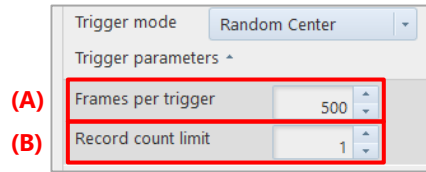

Item	Name	Function
(A)	Frames per trigger	Set the number of frames to record for every trigger input.
(B)	Record count limit	Set the maximum number of triggers to apply. It must be an integer between 1 and 10.

## ■ Random manual mode

As with the random center mode, every time a trigger is input, a preset number of frames before and after trigger input will be recorded. In the random center mode, the proportion of frames to record before and after trigger input is equal; in the random manual mode, however, you can set the desired number of recording frames before and after the important moment to record.

Example: When, with the camera that can make a recording for 2 seconds (2,000 frames) in total, the number of recording frames before and after the event is set at 250 and 750 respectively. (1,000 fps, maximum number of triggers: 2)

After the [Record] button is clicked, the recording loop state will be established, recording specified frames of high-speed images before and after the click of the [Ready] button.

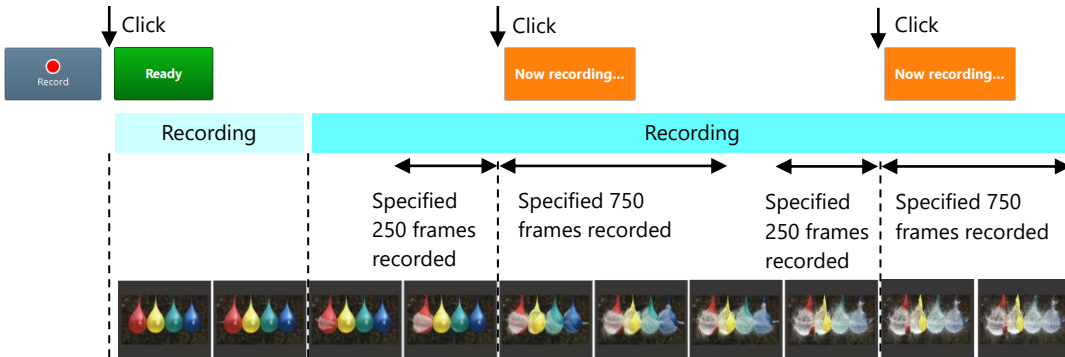

Before recording images in the random manual mode, you need to make the following settings.

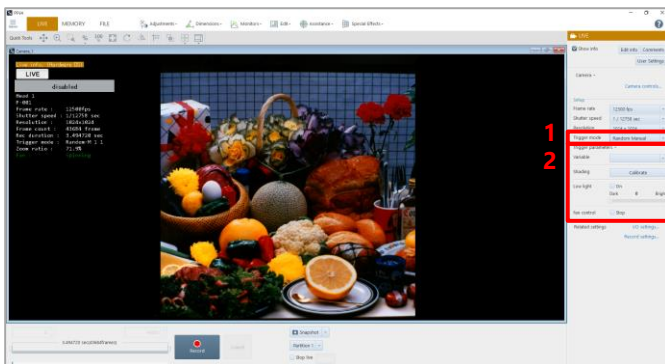

1. Choose [Random manual] from the list to be displayed by clicking [Trigger mode]. Setting items corresponding to the random manual mode are displayed.
2. Make the settings.

## ■ Setting random manual mode

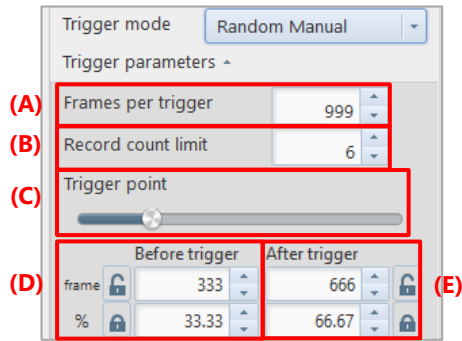

Item	Name	Function
(A)	Frames per trigger	Set the number of frames to record for every trigger input.
(B)	Record count limit	Set the maximum number of triggers to apply. It must be an integer between 1 and 10.
(C)	Trigger point	Use one of the following methods to specify the number of frames to record before and after trigger input. <ul style="list-style-type: none"> <li>• Drag the slider bar of [Trigger point].</li> <li>• Enter the frame count for [Before trigger] and [After trigger].</li> <li>• Enter the proportion of the frame count for [Before trigger] and [After trigger].</li> </ul> For the lock function, refer to the “4.3.2 Lock Function in Trigger Parameter” on page 66.
(D)	Before trigger	
(E)	After trigger	

## ■ Random reset mode

This mode synchronizes a trigger signal and the camera's timing signal, then starts recording.

In the random mode or the start mode, a camera starts recording at the time of trigger input; however, camera's internal timing signal is operating irrespective of the trigger input timing. Therefore, depending on the circumstances, the start of the first frame will not correspond exactly with the trigger time and can vary from shot to shot by a maximum of 1 frame.

In the random reset mode, the camera's internal timing is reset by inputting a trigger. This synchronizes the first frame start timing for the trigger input, improving the timing accuracy.

Difference between random mode and random reset mode

### <For random mode>

Camera's Internal Timing Signal  
Frames to be recorded

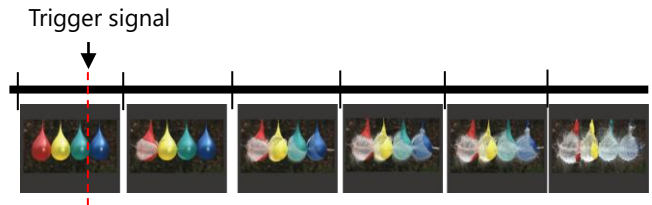

The camera's internal timing signal is not changed by the trigger signal input. The frame exposed when the trigger is input is recorded as the first frame, thereby causing a misalignment between the trigger signal and the internal frame timing.

### <For random reset mode>

Camera's Internal Timing Signal  
Frames to be recorded

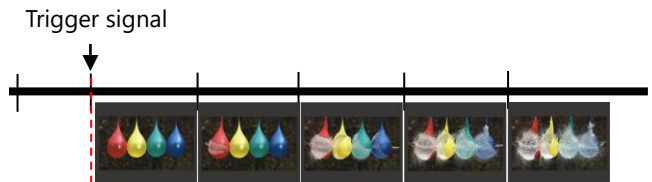

The camera's internal timing signal is reset and synchronized by the trigger signal input.

Before recording images in the random reset mode, you need to make the following settings.

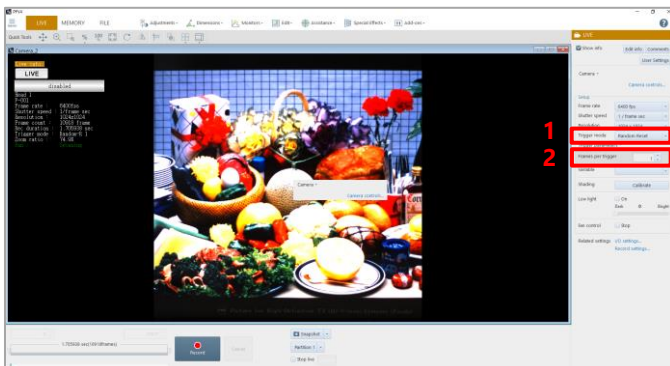

1. Choose [Random reset] from the list to be displayed by clicking [Trigger mode]. Setting items corresponding to the random reset mode are displayed.
2. Make the settings. For details of the settings, see "Setting random mode" on page 86.

## ■ REC ON CMD mode

Data is recorded only while the external SW or TTL trigger is input.

Recording data will stop when the trigger signal is interrupted and will resume when it is input again.

Recording can continue until the maximum recordable frame count is reached; however, the number of trigger inputs is limited to 1,000.

Example: When a trigger is input by the TTL signal

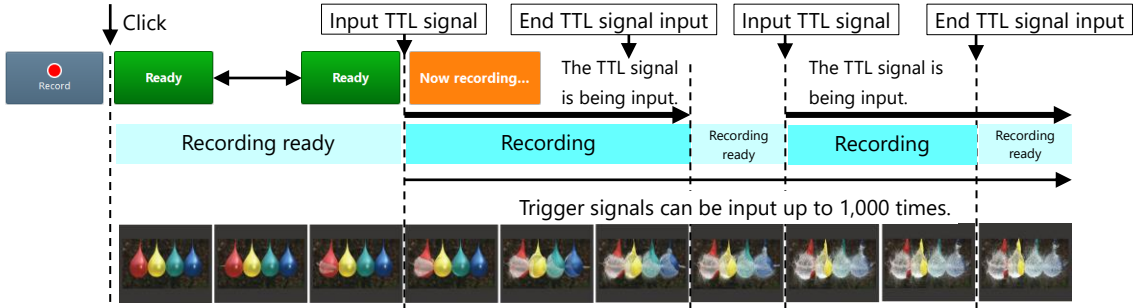

### ⚠ CAUTION

- In this mode, PFV can make the system enter the recording ready state but cannot input a trigger.
- Triggers can be input from outside only.

### ☰ NOTE

For shooting in “REC ON CMD”, the first and last frames to be recorded vary with the camera model.

Recording frames to which a trigger signals is always inputted during exposure: SA-Z, SA-X2

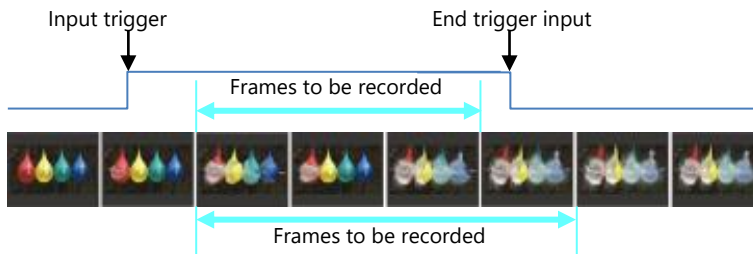

Start recording on the frame next to the frame to which a trigger signal is input and stop recording after the frame on which inputting a trigger signal ends: Mini AX 200, Mini AX 100, Mini AX 50

Before recording images in the REC ON CMD mode, you need to make the following settings.

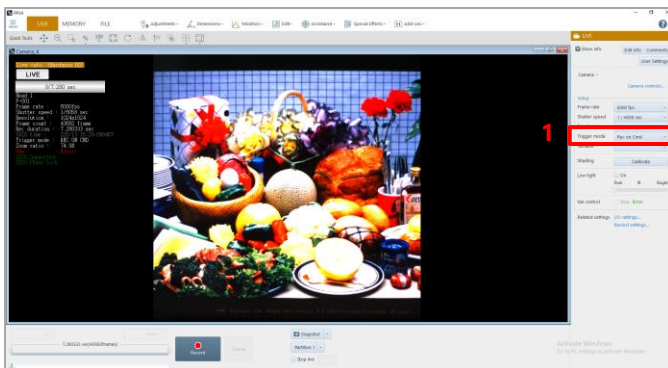

1. Choose [Rec On Cmd] from the list to be displayed by clicking [Trigger mode].

## ■ Random loop mode

In the random loop mode, as with the random mode, every time a trigger is input, only a preset number of frames will be recorded on the memory.

The difference between this mode and the random mode is that when finishing recording the preset number of frames, it will go back and record (overwrite) the first frame and continue to loop and overwrite until the recording is stopped.

Example: When shooting is made four times with the memory holding 3,500 frames and the number of random frames set at 1,000. On the 3rd shooting, 3,000 frames have been recorded. Since the remainder is 500 frames, the shooting for them will not be made. Shooting will be made from the first frame again (data will be overwritten). It repeats as follows: 1st time => 2nd time => 3rd time => 1st time => 2nd time => ...

The number of shooting frames for each trigger can be set freely from 1 frame to the maximum recordable frame count, in 1 frame increments.

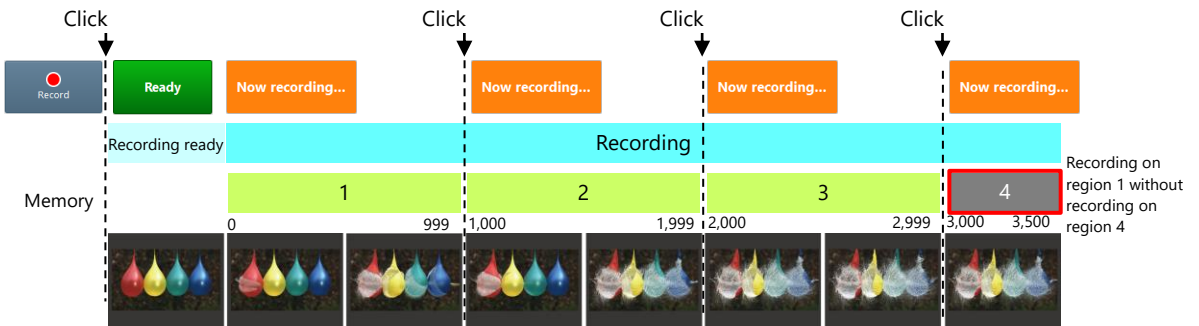

Before recording images in the random loop mode, you need to make the following settings.

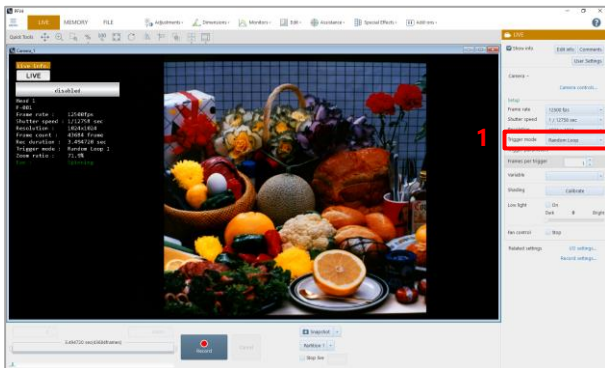

1. Choose [Random Loop] from the list to be displayed by clicking [Trigger mode]. Setting items corresponding to the random loop mode are displayed.

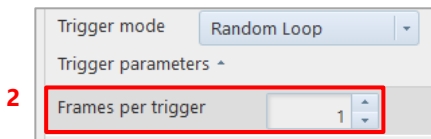

2. Enter the number of frames to record for every trigger input. Enter the desired value in [Frames per trigger].



## 4.4.4. Setting Hardware Image Trigger

The hardware image trigger is a function to allow the hardware to detect a change in image and automatically input a trigger to start recording. When a camera supports the hardware image trigger, “H/W image trigger” is displayed on the “Trigger mode” list on “LIVE”. On the [H/W image trigger settings] screen, you can set up this feature.

The reference range should be specified in advance. When the average brightness in the range goes out of the set threshold range, the trigger will be input. For color images, the G (green) value of RGB is used as a criterion.

Trigger information is displayed in the information display and tool menu.



### CAUTION

- The image trigger function does not guarantee that it can capture 100% of image changes. Depending on the circumstances, this function may overlook image changes, or the trigger may be applied when you feel no change in the image has happened. Fully understand the characteristics of the function, and do not use it in situations where a trigger failure is unacceptable.
- Use this function after fully testing it. Depending on how the image changes and how the settings are made, a change in image is more likely to be captured with a higher probability.

Before recording images using the H/W image trigger, you need to make the following settings.

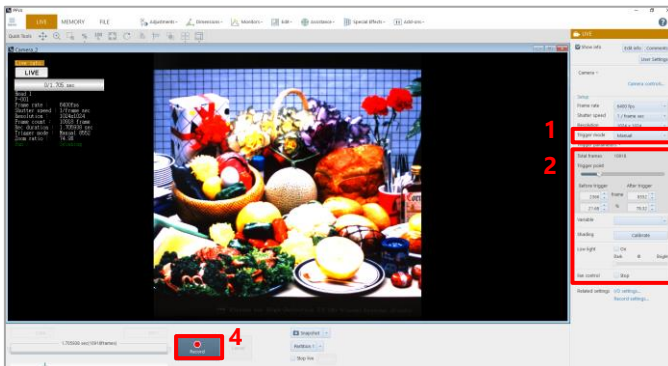

1. Choose [H/W image trigger] from the list to be displayed by clicking [Trigger mode].  
Setting items corresponding to the hardware image trigger are displayed.
2. Make the settings.  
For details of the settings, see “[H/W image trigger settings] screen” on page 94.
3. Click the [OK] button.
4. Click the [Record] button.  
The Ready state is established. When a change in image happens, the trigger will be input.

■ [H/W image trigger settings] screen

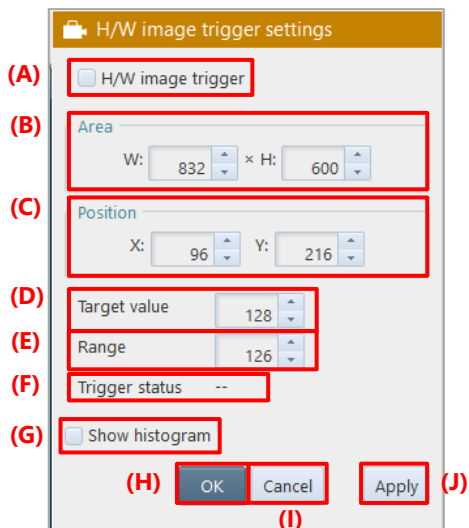

Item	Name	Function
(A)	H/W image trigger	Check this to enable the hardware image trigger function.
(B)	Area	Specify the range (width and height) and (X/Y-coordinates) of the reference image for hardware image trigger detection. You can also drag the video display region to specify the range.
(C)	Position	Specify the start position of the reference image area. You can also click the video display region to specify the start position.
(D)	Target value	Specify the image output level.
(E)	Range	Specify the allowable range for the image output level.
(F)	Trigger status	Displays “Triggered” or “No Triggered” as the trigger detection state according to “Value” and “Range”.
(G)	Show histogram	Checking [Show histogram] displays the histogram of the specified range.
(H)	OK	Applies the settings to the camera and closes this screen.
(I)	Cancel	Closes the screen without applying the changed settings.
(J)	Apply	Applies the settings to the camera.

# 5

## Chapter 5 Recording and Data Playback

This chapter describes the recording method of PFV4 and how to play back recorded images.

# 5.1. Recording

A recording is made by using the recording/playback panel in LIVE mode. The indication [Record] changes according to the status. In addition, the indication also varies with the set trigger mode.



## REFERENCE

For trigger modes, see “4.4.1 What Is Trigger Mode?” on page 77.

### 5.1.1. For Start, Random, Random Reset, Random Center, and Random Loop Modes

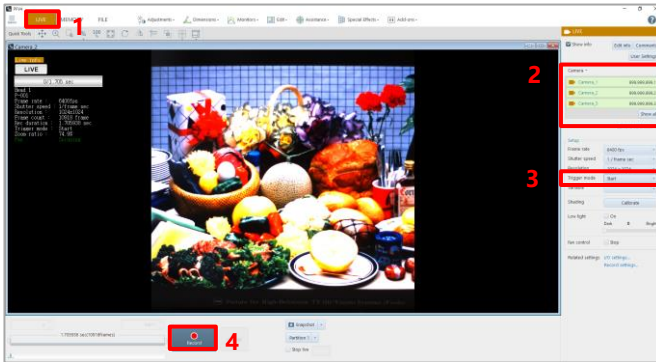

1. Click the [LIVE] tab.
2. Select a camera to use from the list to be displayed by clicking [Camera] on the function panel.
3. Choose [Start], [Random], [Random Reset], [Random Center], or [Random Loop] from the list to be displayed by clicking [Trigger mode].
4. Click the [Record] button.

The recording ready state is established, and the text displayed on the button changes to [Ready].

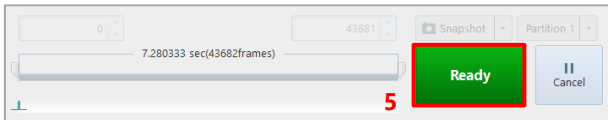

5. Click the [Ready] button. Recording starts, images are recorded on the camera, and the text displayed on the button changes to [Now recording...]. To cancel the recording ready state, click the [Cancel] button.

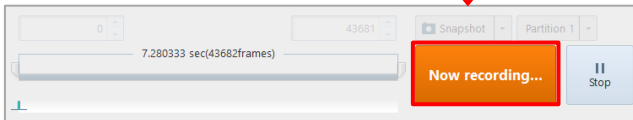

### How to stop recording

Clicking the [Cancel] button to stop recording. The text displayed on the button will change to [Now recording]. The mode will be MEMORY or LIVE mode.



## NOTE

- For trigger inputs from outside, input the signals in the state of [Ready] or [Now recording...].
- For signal input connectors and signal specifications, see the camera’s hardware manual.

## 5.1.2. For Center, End, and Manual Modes

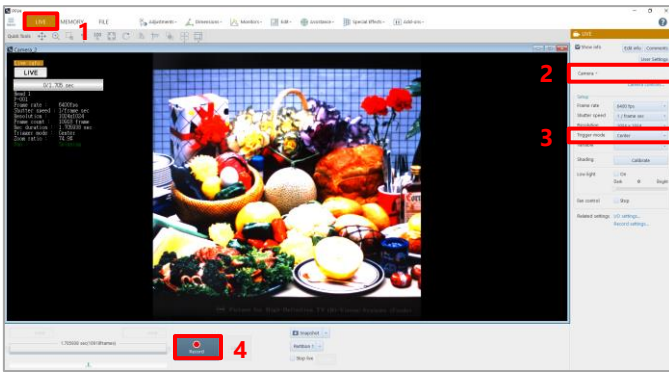

1. Click the [LIVE] tab.
2. Select a camera to use from the list to be displayed by clicking [Camera] on the function panel.
3. Choose [Center], [End], or [Manual] from the list to be displayed by clicking [Trigger mode].
4. Click the [Record] button.

If the following warning message appears, click the [OK] button.

“Do you want to start recording to camera memory?”

The text displayed on the button changes to [Ready], recording starts, and images are recorded on the camera.

To cancel the recording ready state, click the [Cancel] button.

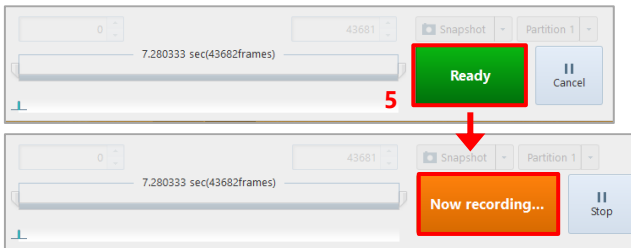

5. Click the [Ready] button.  
The trigger is input, and the text displayed on the button changes to [Now recording...].

### How to stop recording

Clicking the [Cancel] button to stop recording. The text displayed on the button will change to [Now recording]. The mode will be MEMORY or LIVE mode.

#### NOTE

- Triggers can also be input from outside.
- For trigger inputs from outside, input the signals in the state of [Ready].
- For signal input connectors and signal specifications, see the camera’s hardware manual.

#### REFERENCE

- If [MENU] - [Configuration] - [Camera Option] - [Auto playback] is set to [AUTO PLAY], the recorded image will be played back automatically after recording is finished.
- For automatic playback settings, see “10.7 Camera Option Settings” on page 316.

### 5.1.3. For Random Center and Random Manual Modes

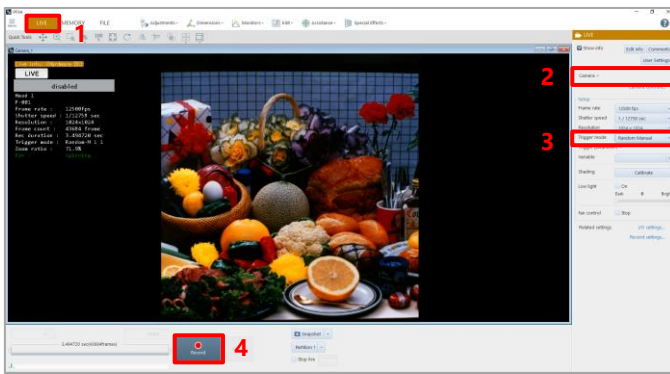

1. Click the [LIVE] tab.
2. Select a camera to use from the list to be displayed by clicking [Camera] on the function panel.
3. Choose [Random Center] or [Random Manual] from the list to be displayed by clicking [Trigger mode].

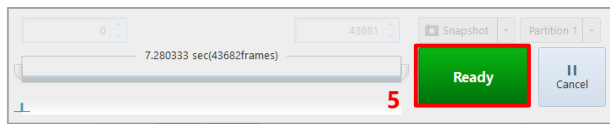

4. Click the [Record] button.  
The text displayed on the button changes to [Ready], and the recording ready state is established.

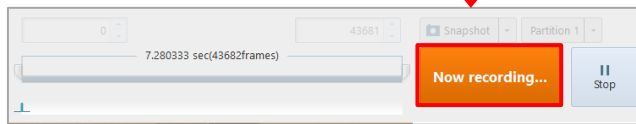

5. Click the [Ready] button.  
The text displayed on the button changes to [Now recording...], and recording is made by the specified frame count. When the recording is finished, the text displayed on the button changes to [Ready].
6. To continue to make recording, repeat step 5.  
To cancel the recording ready state, click the [Cancel] button.

#### How to stop recording

Clicking the [Cancel] button to stop recording. The text displayed on the button will change to [Now recording]. The mode will be MEMORY or LIVE mode.



#### CAUTION

When using the Random Center trigger or Random Manual trigger, an interval of about 1 second is required between trigger inputs.

## 5.1.4. For Rec On Cmd Mode

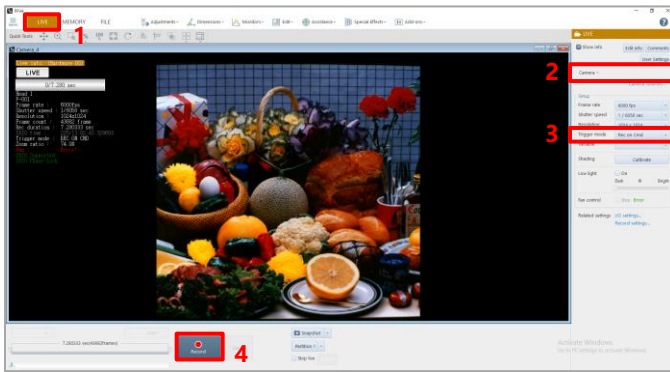

1. Click the [LIVE] tab.
2. Select a camera to use from the list to be displayed by clicking [Camera] on the function panel.
3. Choose [Rec On Cmd] from the list to be displayed by clicking [Trigger mode].
4. Click the [Record] button.

The text displayed on the button changes to [Ready], and the recording ready state is established.

From here on, the recording and the recording ready state are repeated according to the inputs from outside.

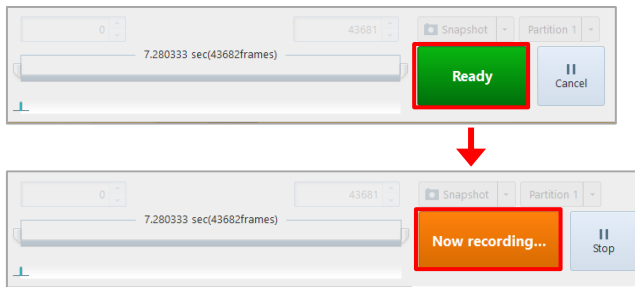

### How to stop recording

Clicking the [Cancel] button to stop recording. The text displayed on the button will change to [Now recording]. The mode will be MEMORY or LIVE mode.

## 5.2. Playing Back Recorded Data

Here, how to play back recorded images is described.

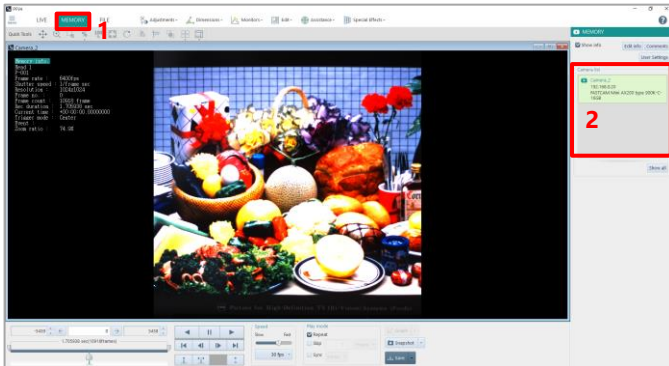

1. Click the [MEMORY] tab.
2. Select a camera that contains the recorded images to play back, from the camera selection panel on the function panel.

### NOTE

When, with multiple cameras connected, you choose [All cameras], images in all the cameras can be played back synchronously.

### REFERENCE

For synchronized playback, see “7.1.2 Opening Multiple Saved Data” on page 153.

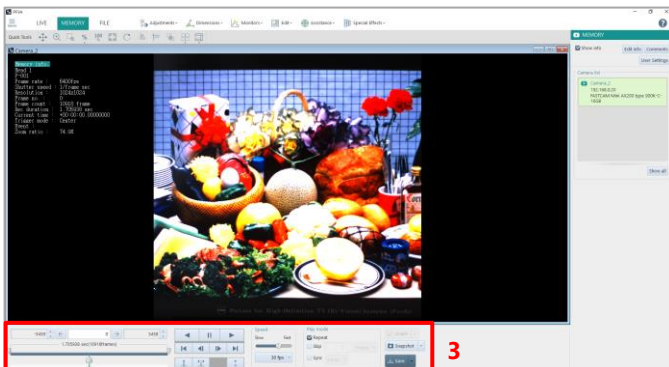

3. Use the recording/playback panel for playback.  
For the recording/playback panel, see “Recording/playback panel” on the next page.



## ■ Recording/playback panel

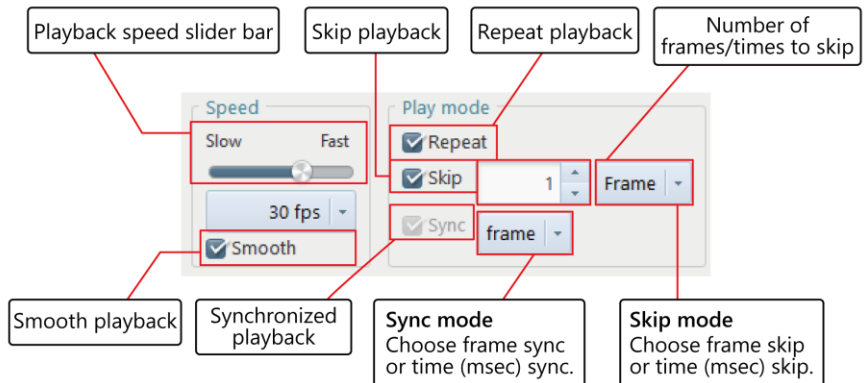
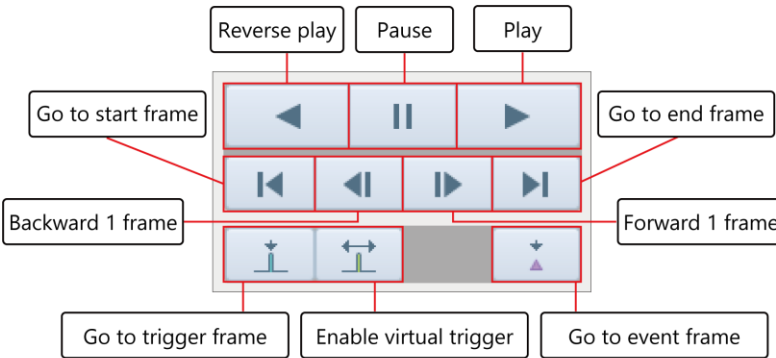
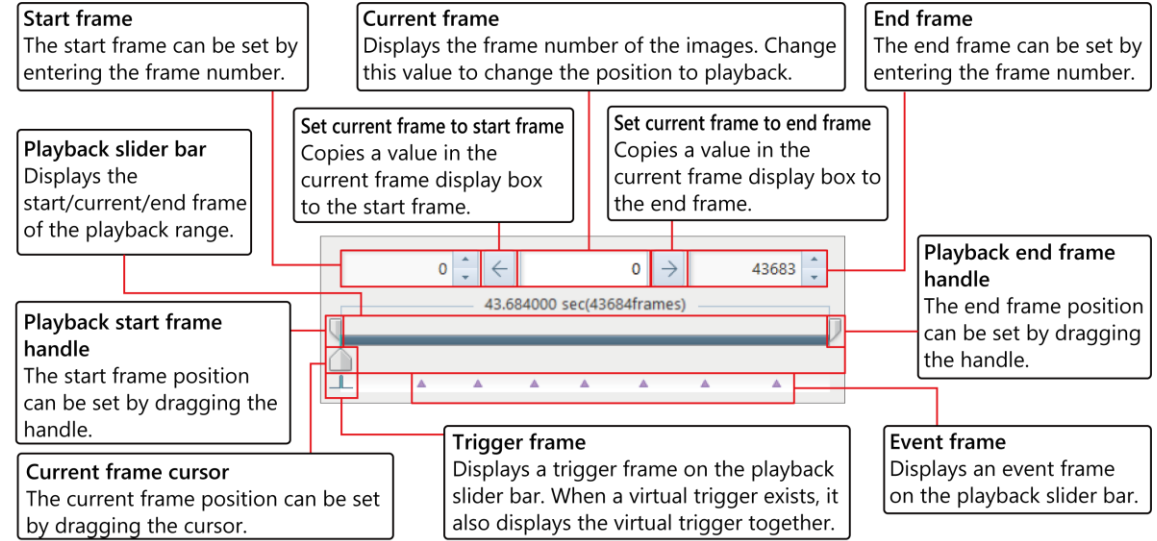



## NOTE

- In the view window information, the time code can be displayed during playback only.
- The number of time code digits displayed can be changed by using the “Time Code Display Settings” screen to be displayed by clicking the [Settings] button of “Customize time code”.

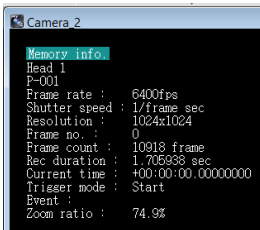

```
Camera 2
Memory info
Head 1
P-001
Frame rate : 6400fps
Shutter speed : 1/frame sec
Resolution : 1024x1024
Frame no. : 0
Frame count : 10918 frame
Rec duration : 1.706988 sec
Current time : +00:00:00.00000000
Trigger mode : Start
Event :
Zoom ratio : 74.9%
```



## REFERENCE

For how to change the number of time code digits displayed, see “10.10.1 Time Code Display Settings” on page 322.

## 5.3. How to Play Back Various Data

### 5.3.1. Playback at Desired Speed

The playback speed can be changed.

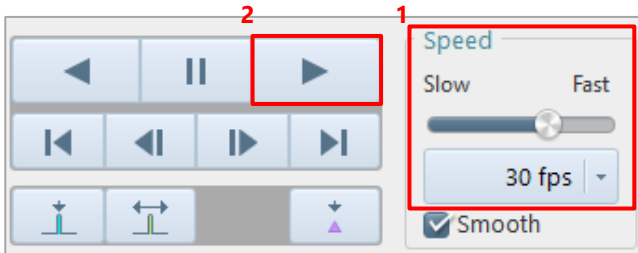

1. Select the desired speed (frames per second) from “Speed” on the recording/playback panel.  
You can also drag the “playback speed slider bar” knob to specify that.  
The playback speed slider bar and the selected speed are displayed in synchronization.
2. Click the [Play] button to play back.  
Playback starts at the specified speed.

### 5.3.2. Moving to Trigger Frame

The light-blue vertical line displayed on the playback slider bar indicates a trigger frame.  
The trigger frame image can be displayed by moving the current frame cursor to the trigger frame.

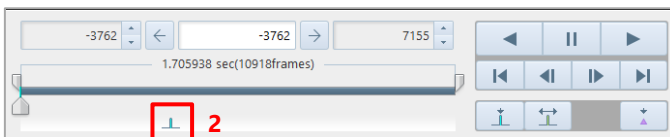
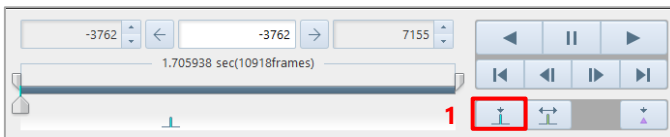
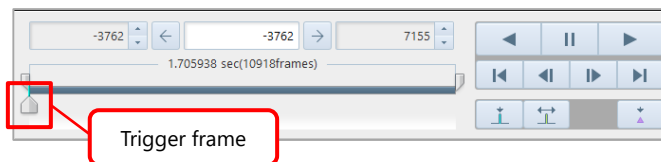

1. Click the [Move to the trigger frame] button on the recording/playback panel.
2. Select the desired speed (frames per second) or drag the “playback speed slider bar” knob to specify that.  
If the event frame is out of the playback range, the current frame moves to the upper- or the lower-limit position.  
In addition, if you execute moving to a trigger frame with multiple cameras selected, the current frame of every camera moves to the trigger frame.

### 5.3.3. Moving to Freely Set Trigger Frame

Besides the trigger frame recorded in the images, you can set the desired frame as a virtual trigger frame. The virtual trigger frame image can be displayed by moving the current frame cursor to the set virtual trigger frame. In addition, when you set a virtual trigger frame, the virtual trigger frame will be displayed as 0.

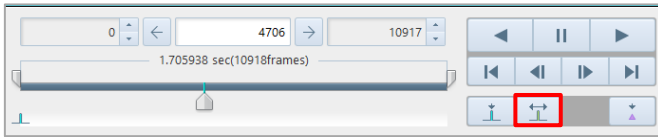

1. Click the [Virtual trigger frame] button to turn this ON.

The current frame turns green.

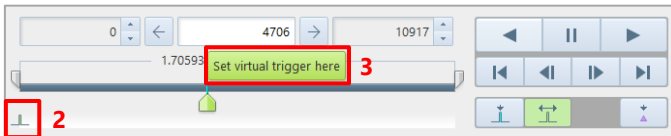

2. On the playback slider bar, drag the current frame cursor to the desired position to be a virtual trigger frame. "Set virtual trigger here" is displayed.
3. Click [Set virtual trigger here].

#### CAUTION

- While the virtual trigger frame is ON, you cannot move to the original trigger frame by using the [Move to the trigger frame] button.

To use the original trigger frame, turn OFF the virtual trigger frame.

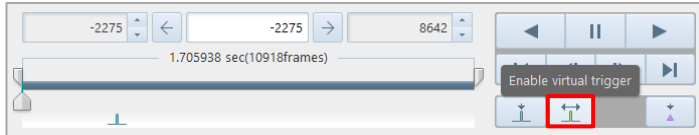

- When you click the [Move to the trigger frame] button with the virtual trigger frame ON, you will move to the set virtual trigger frame.

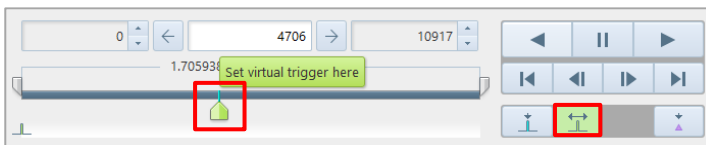

#### NOTE

When an INF file (\*.ini) is opened, you also can move the trigger frame by clicking "Apply current trigger frame" from right-click over the file in the file list.

## 5.3.4. Moving to Event Marker

The light-blue vertical lines displayed on the playback slider bar indicate an event marker.

The image of a frame with the event marker can be displayed by moving the current frame cursor to the event marker.

For how to input the event marker, see the camera's hardware manual.

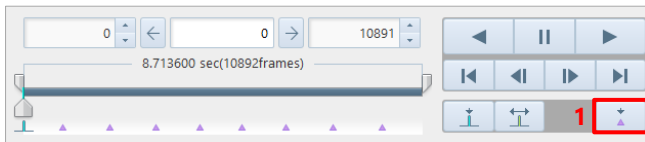
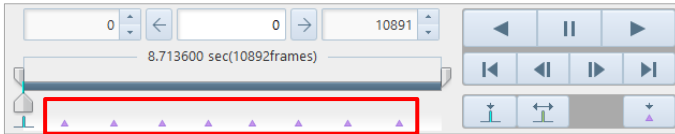

1. Click the [Move to the event] button on the recording/playback panel.

The current frame cursor moves to the event marker, and the image of a frame with the event marker is displayed in the view window.

When clicking the [Move to the event] button after moving to the last event marker on the playback speed slider bar, you will move to the first event marker. In addition, if you execute moving to an event marker with multiple cameras selected, the current frame of every camera moves to the event marker.

### 5.3.5. Playback with Playback Range Specified

Only the desired range (part) of recorded images will be played back.

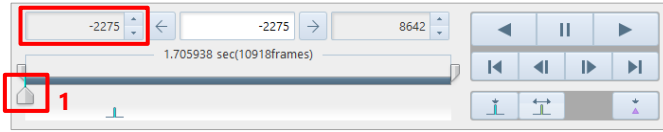

1. Enter the start frame number of the playback range in the replay start frame display/input box. You can also drag the “replay start frame handle” on the playback slider bar instead.

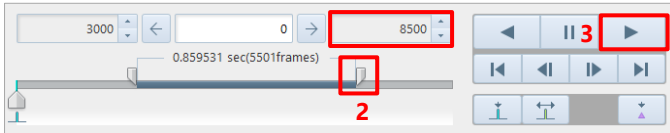

2. Enter the end frame number of the playback range in the replay end frame display/input box. You can also drag the “replay end frame handle” instead.

3. Click the [Play] button.  
Only the specified range is played back.



#### IMPORTANT

- The specified range is maintained even if the recording/playback panel tabs are switched.
- After the range is specified, only the specified range will be saved to the PC when you execute a file save command.



#### REFERENCE

For file save, see “6.2 Saving Recorded Data” on page 113.

### 5.3.6. Smooth Play

Drop frames occur during playback depending on the playback speed and compression setting of recorded images. Checking “Smooth” enables to play back all the frames without any drop frame. However, the playback speed can differ from the specified rate in the “Speed” setting.

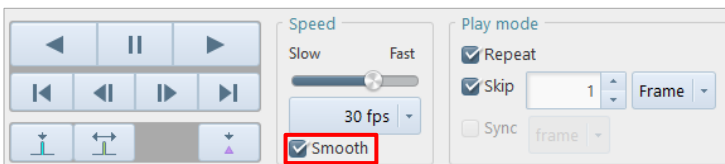

## 5.3.7. Repeat Playback

Checking [Repeat] enables the repeat playback function.

When playback ends in the playback range, the playback will automatically start at the head of the range. Even if clicking the frame advance button at the end, you are not taken to the head.

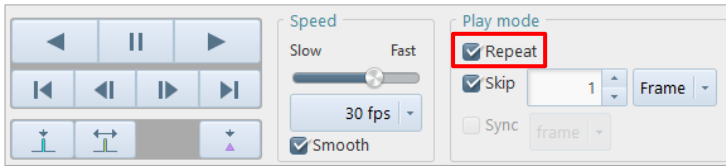

## 5.3.8. Skip Playback

During playback, images can be skipped by a desired number of frames/seconds.

Even when you execute moving frames ahead/back, they will be skipped by a specified number of frames/seconds.

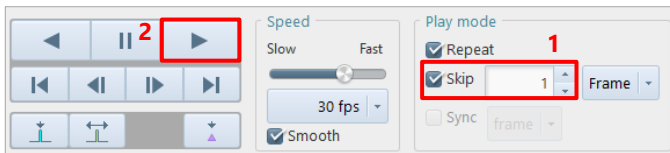

1. Check [Skip] and enter the number of frames/seconds to skip.
2. Click the [Play] button.

The skip playback starts at the area start frame.

### NOTE

- The relation between the skip value and the frames displayed is as follows.  
When “Frame” is selected  
When “1” is specified:  
Frames are displayed without being skipped in the order of 1st frame, 2nd frame, 3rd frame . . .  
When “2” is specified:  
Frames are displayed in the order of 1st frame, 3rd frame, 5th frame . . .  
When the playback speed is set at 30 fps, the 30th frame is displayed in 1 second.  
300th frame is displayed in 10 seconds.  
When the skip frame is set at 10, the 3,000th frame is displayed in 10 seconds.  
When “msec” is selected  
When “10” is specified:  
1,000 fps video -> 1 frame is 0.001 sec (= 1 msec) -> 1 out of 10 frames is displayed  
2,000 fps video -> 1 frame is 0.002 sec (= 2 msec) -> 1 out of 5 frames is displayed  
When the playback speed is set at 30 fps, the 30th frame (3.000 sec) is displayed in 1 second.  
300th frame (0.300 sec) is displayed in 10 seconds.
- When the skip frame is set at 10 [msec], the 3,000th frame (3.000 sec) is displayed in 10 seconds.
- During skip playback, the trigger frame is played back without skipping.

## 5.3.9. Synchronized Playback

---

You can select multiple cameras or files and play back images in synchronization with frame or time. When multiple cameras are selected in MEMORY mode, the synchronized playback is always executed. The synchronized playback has two modes: “frame playback” and “time synchronization”. Choosing “frame playback” will make synchronization with the frame count. Choosing “time synchronization” will make synchronization with the time.



## 5.4. Switching Partitions

When the camera memory is partitioned, the recording destination partition can be specified.



### CAUTION

- It can be specified when the partitions have been created in advance.
- It is not available to cameras without the partition function.

Select it from the list to be displayed by clicking [P-001] on the recording/playback panel.

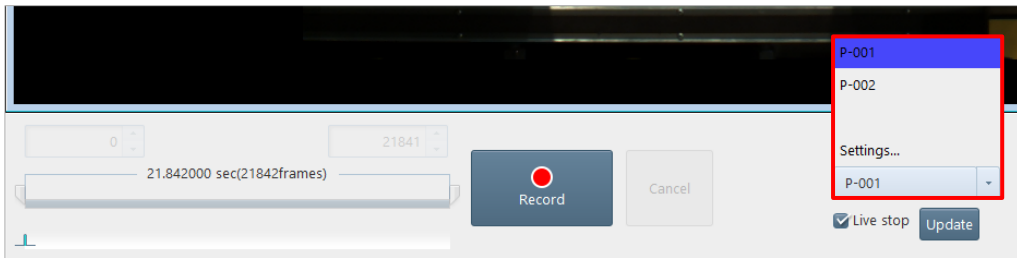

### REFERENCE

For the partitioning and increment settings, see “10.4 Recording Setting” on page 302.

# 6

## Chapter 6 Saving Data

Images recorded on a camera will be lost when the camera is turned off. Therefore, to keep the recorded images, you need to save them from the camera to the PC or an external media such as SD card. This chapter describes how to save files to them.

# 6.1. File Save Settings

Here, option items that can be set during file save are described.  
 The item settings are displayed on the preview pane in the right part of the screen.  
 To apply the settings, click the [Apply] button.

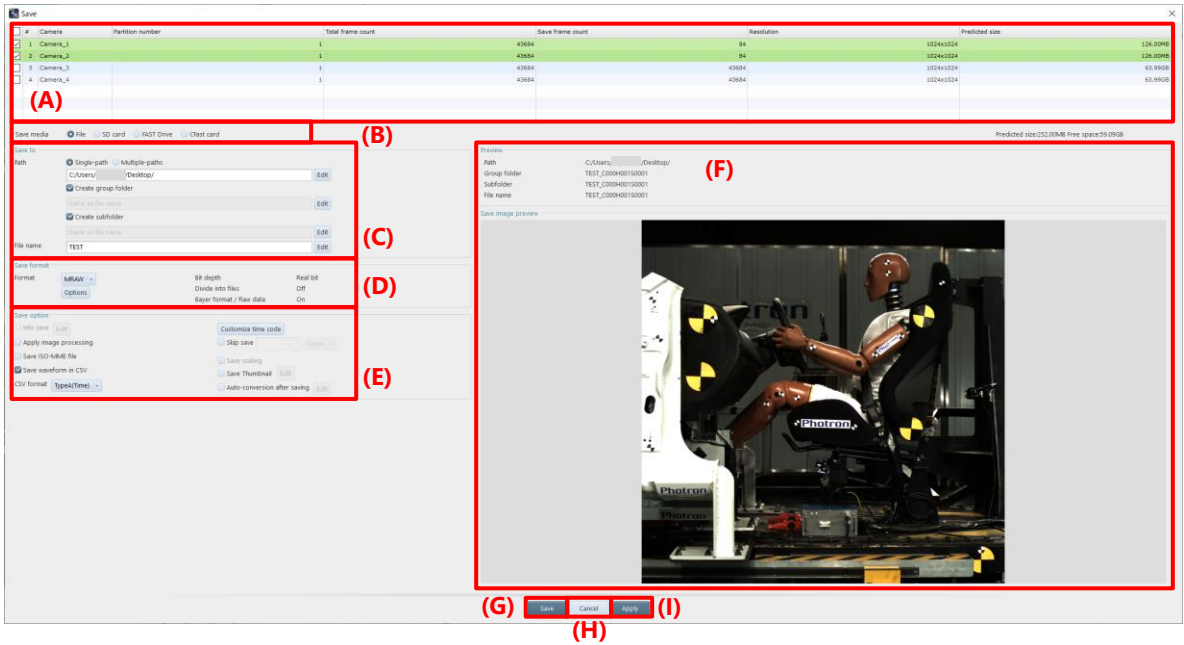

Item	Name	Function	
(A)	File list	Check the target file for save.	
(B)	Save media	Choose “File”, “SD Card”, “FAST Drive”, or “CFast” as a medium in which to save the selected file.	
(C)	Save to	Single-path	Save selected data to a single path. Click the [Edit] button to specify the destination path.
		Multiple-paths	Save the selected data from multiple cameras simultaneously to the paths registered for each. Click the [Edit] button to specify the destination path. For details, see “6.2.2 Edit multiple save path” on page 115.
		Create group folder	Clicking the [Edit] button displays the edit dialog for each item.
		Create subfolder	
File name			
(D)	Save format	Choose the format in which to save the file. Clicking the [Options] button allows you to make detailed settings. The setting items vary with the file format. For details, see “6.2.9 File Formats and Options” on page 126.	

Item	Name	Function
(E)	Save option	These are functions for setting various options when saving a file. For details, see “6.2.10 Save Options” on page 132.
(F)	Preview	Displays the destination, file name, and image in the file to be saved.
(G)	Apply	Applies the settings and closes this screen. The file will not be saved.
(H)	Save/OK	<p>The button name and the processing vary with the setting of automatic save.</p> <p>When automatic save is not set  Button name: Save  Processing: Applies the settings, saves the file, and closes this screen.</p> <p>When automatic save is set  Button name: OK  Processing: Applies the settings and closes this screen.</p> <p>When the file is saved automatically, the settings on this screen will be applied.</p>
(I)	Cancel	Closes the screen without applying the changed settings.

## 6.2. Saving Recorded Data

### 6.2.1. Saving Images to PC

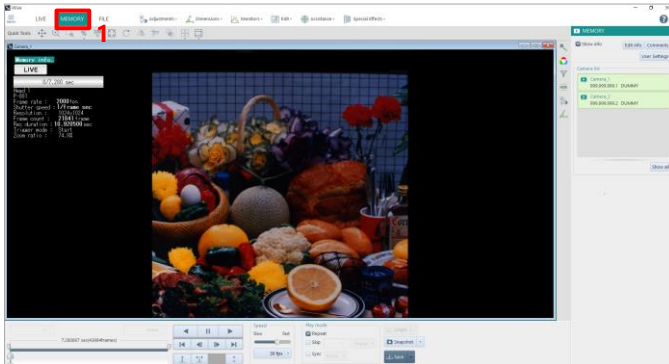

1. Click the “MEMORY” tab.

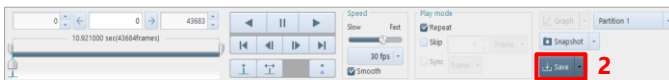

2. Click the [Save] button on the recording/playback panel.  
The [Save] screen is displayed.

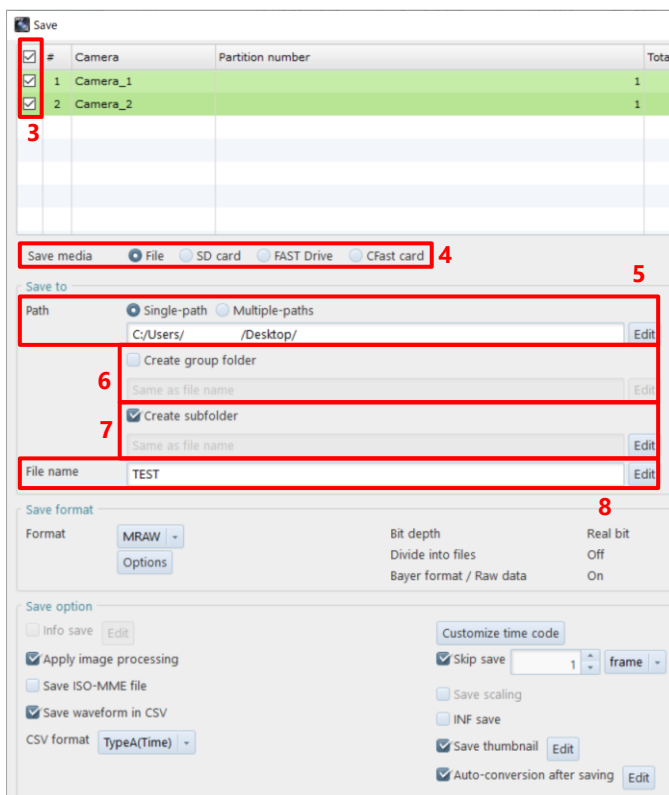

3. Check the file to save.
4. Choose the destination media.  
The [Save] screen is displayed.
5. Specify the destination folder.  
Single-path: Clicking the [Edit] button displays the [Select folder] screen, where you can make detailed settings.  
Multiple-paths: Clicking the [Edit] button displays the [Edit multiple save path] screen, where you can make detailed settings.
6. Create the group folder.  
Clicking the [Edit] button displays the [Edit Group Folder Name] screen, where you can make detailed settings.
7. Create the subfolder.  
Clicking the [Edit] button displays the [Edit Subfolder Name] screen, where you can make detailed settings.
8. Specify the filename.  
Clicking the [Edit] button displays the [Edit File Name] screen, where you can make detailed settings.

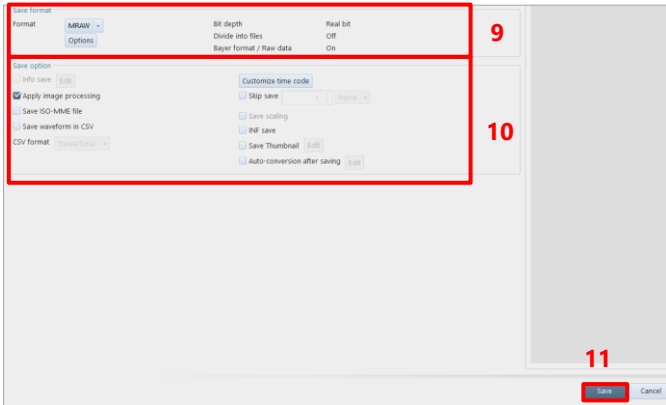

9. In “Save format”, select a format in which to save the file, from the list to be displayed by clicking.  
Available formats are RAWW, MRAW, GRAW, TIFF, BMP, JPEG, PNG, AVI, MP4, and MOV.  
Depending on the format, the [Options] button becomes active and can be set.
10. Set “Save option”.
11. Click the [Save] button.

The selected file is saved by this procedure.

## NOTE

- Specifying the save path:

“**Single-path**”: If you check the box, the selected data will be saved to a single path. Click the [Edit] button to specify the destination path.

“**Multiple-paths**”: If you check the box, the selected data from multiple cameras will be saved simultaneously to the paths registered for each. Click the [Edit] button to specify the destination path. e.g.) Camera 1 data can be downloaded to “C Drive” and Camera 2 data to “D Drive” in parallel.

“**Same as original path**”: If you check the box, the image will be saved in the folder where it is saved.

“**Create group folder**”: If you check the box, a group folder is created, and the images will be saved together.

If you select multiple files that were recorded on different partitions of the same camera, you cannot create a group folder.

“**Create subfolder**”: If you check the box, a subfolder is created, and the image will be saved in the folder.

“**File name**”: Save the image with the file name you edited.

## REFERENCE

- For details of the [Save] screen, see “6.1 File Save Settings” on page 111.
- For details of the save format settings, see “6.2.9 File Formats and Options” on page 126.
- For details of the save option settings, see “6.2.10 Save Options” on page 132.
- You can also save only the desired range (part) of recorded images. When you specify the playback range in “5.3.5 Playback with Playback Range Specified” on page 106, only the specified range of images will be saved to the PC.

## 6.2.2. Edit multiple save path

Register the destination path and link the camera to the destination path.

Path list

Path name	Path
Camera 1	C:/Users/[redacted]/Desktop/Camera_1/
Camera 2	C:/Users/[redacted]/Desktop/Camera_2/
Camera 3	C:/Users/[redacted]/Desktop/Camera_3/

(A)

Add (B)

Path list per camera

Camera	Select path	Path
999,999,999.1	Camera 1	C:/Users/[redacted]/Desktop/Camera_1/
999,999,999.2	Camera 2	C:/Users/[redacted]/Desktop/Camera_2/
999,999,999.3	Camera 3	C:/Users/[redacted]/Desktop/Camera_3/
999,999,999.4	Camera 1	C:/Users/[redacted]/Desktop/Camera_1/

(D)

(E) OK (F) Cancel

Item	Name	Function
(A)	Path list	A list of “Path name” and “Path” will be displayed. Up to 64 paths can be assigned.
(B)	Add	Click the button to add any “Path name” and “Path” to the path list in (A).
(C)	Delete	Delete the path from the path list. If a path is specified in the path selection in (D), it cannot be deleted.
(D)	Path list per camera	Select any path from the Select path drop-down list.
(E)	OK	Applies the settings and closes this window.
(F)	Cancel	Cancels the settings and closes this window.

## 6.2.3. Edit Group Folder Name

The “Create group folder” checkbox is enabled when saving multiple images. The images will be saved in the specified folder. Click the [Edit] button to edit the group folder name.

The screenshot shows the 'Edit Group Folder Name' dialog box. It contains the following elements:

- (A) Preview text box containing the file name: [SAVE\_FILENAME]\_S0001\_20201012\_133354
- (B) Radio button labeled 'Same as file name' (selected)
- (C) Checked checkbox labeled 'Include Add information'
- (D) Radio button labeled 'Apply entered group folder name' (selected) with a text input field containing 'Same as file name'
- (E) Checked checkbox labeled 'Add sequence number' with a 'Settings' button (F)
- (G) Checked checkbox labeled 'Add timestamp' with a pull-down menu showing 'yyyyMMdd\_HHmss'
- (H) 'OK' button
- (I) 'Cancel' button

Item	Name	Function
(A)	Preview	The folder name to save is shown.
(B)	Same as file name	Check this to apply the first file name in the grouped images to the group folder name.
(C)	Include Add information	Check this to give the information added by editing the file name to the group name (“Add information”, “Add sequence number”, and “Add timestamp” settings).
(D)	Apply entered file name	Enter the folder name to apply.
(E)	Add sequence number	Check this to add a number to the folder to save.
(F)	Settings	Configures the setting of (E) Add sequence number. For details, see the “Add sequence number” on page 120.
(G)	Add timestamp	Check this to add the date to the folder name. Select the display method from the pull-down list.
(H)	OK	Applies the settings and closes this window.
(I)	Cancel	Cancels the settings and closes this window.



## 6.2.4. Edit Subfolder Name

Check “Create subfolder” to create subfolder. Click the [Edit] button to edit the subfolder name.

The screenshot shows a dialog box titled "Edit Subfolder Name". It contains the following elements:

- (A) A text field labeled "Preview" containing the text "[SAVE\_FILENAME]\_S0001\_20201012\_142100".
- (B) A radio button labeled "Same as file name" which is selected.
- (C) A checked checkbox labeled "Include Add information".
- (D) A radio button labeled "Apply entered subfolder name" which is unselected, followed by a text field containing "Same as file name".
- (E) A checked checkbox labeled "Add sequence number" and a button labeled "Settings" (F).
- (G) A checked checkbox labeled "Add timestamp" and a pull-down menu showing "yyyyMMdd\_HHmss".
- (H) An "OK" button.
- (I) A "Cancel" button.

Item	Name	Function
(A)	Preview	The folder name to save is shown.
(B)	Same as file name	Check this to apply the first file name in the grouped images to the group folder name.
(C)	Include Add information	Check this to give the information added by editing the file name to the group name (“Add information”, “Add sequence number”, and “Add timestamp” settings).
(D)	Apply entered file name	Enter the folder name to apply.
(E)	Add sequence number	Check this to add a number to the folder to save.
(F)	Settings	Configures the setting of (E) Add sequence number. For details, see the “Add sequence number” on page 120.
(G)	Add timestamp	Check this to add the date to the folder name. Select the display method from the pull-down list.
(H)	OK	Applies the settings and closes this window.
(I)	Cancel	Cancel the settings and closes this window.

## 6.2.5. Edit File Name

Configure this setting to automatically add numbers to the file name or apply the camera name as the file name when to save a file. Click the [Edit] button of [File name] to display this window.

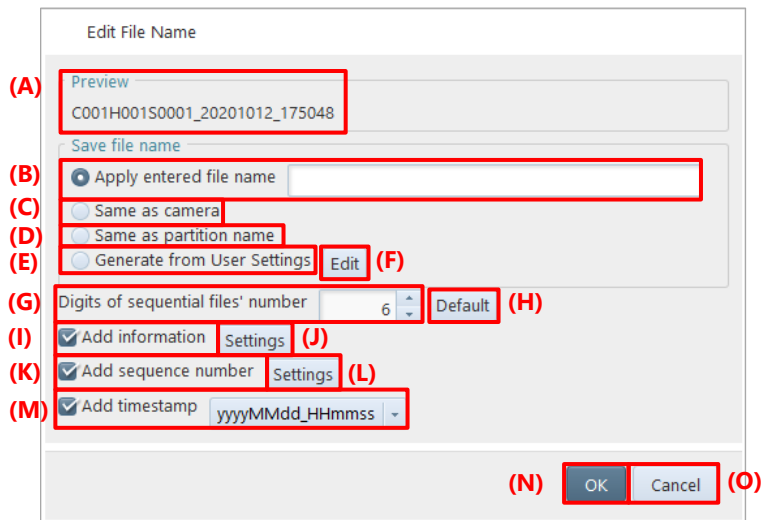

Item	Name	Function
(A)	Preview	The file name to save is shown.
(B)	Apply entered file name	Enter the file name to apply.
(C)	Same as camera	Click this to apply the camera name as the file name.
(D)	Same as partition name	Click this to apply the partition name as the file name.
(E)	Generate from User Settings	Click this to generate a file name from the User Settings.
(F)	Edit	Configures the setting of (E) User Settings. For details, see the “[User Settings] screen” on page 46.
(G)	Digits of sequential files's number	Decide the numbers of digits for a sequential number that is added when to save an image file such as BMP or TIFF, etc.
(H)	Default	Returns the settings to default values.
(I)	Add information	Check this to add various information to the file name.
(J)	Settings	Configures the setting of (I) Add information. For details, see the “Add information” on page 119.
(K)	Add sequence number	Check this to add a number to the file name.
(L)	Settings	Configures the setting of (K) Add sequence number. For details, see the “Add sequence number” on page 120.
(M)	Add timestamp	Check this to add the date to the file name.
(N)	OK	Applies the settings and closes this window.
(O)	Cancel	Cancels the settings and closes this window.

## Add information

The screenshot shows the 'Add information' dialog box. It features a 'Preview' field at the top, an 'Add item' section with a checked 'Connector' checkbox, and a list of items with delete buttons. The 'OK' and 'Cancel' buttons are at the bottom right.

Item	Name	Function
(A)	Preview	The file name to save is shown.
(B)	Add item	Adds information to the file name. Only the “Free text” item can be edited. Click [X] to delete the added information.
(C)	Connector	Check this to insert an underscore “_” between the added items.
(D)	OK	Applies the settings and closes this window.
(E)	Cancel	Cancels the settings and closes this window.

## Add sequence number

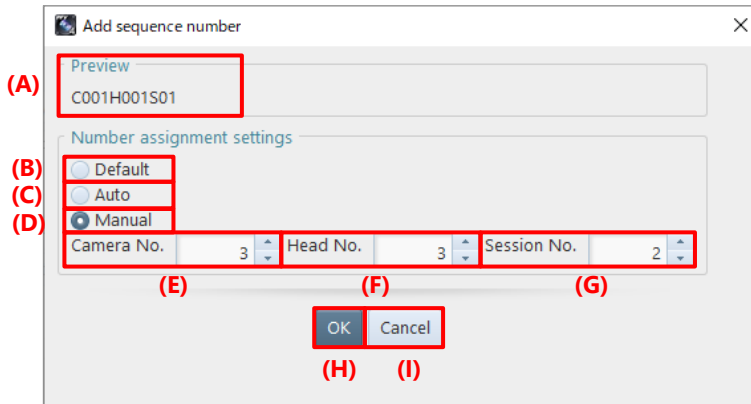

Item	Name	Function
(A)	Preview	The file name to save is shown.
(B)	Default	The camera No. is added as C+3 digits, the head No. is added as H+3 digits, and the session No. is added as S+4 digits.
(C)	Auto	<ul style="list-style-type: none"> <li>• Camera No.: Adds the number according to the number of the camera units to save. For example, 2 is given if there are 10 camera units.</li> <li>• Head No.: Adds the number according to the number of heads of the camera to save; automatically specifies the value from the number of heads if it is 1 or more. For example, if there are 2 heads, added as 1.</li> <li>• Head No.: Fixed to 4.</li> </ul>
(D)	Manual	Enables specifying each number.
(E)	Camera No.	When “Manual” is selected, specify each number between 0 and 8.
(F)	Head No.	
(G)	Session No.	
(H)	OK	Applies the settings and closes this window.
(I)	Cancel	Cancels the settings and closes this window.

■ How to save using each feature

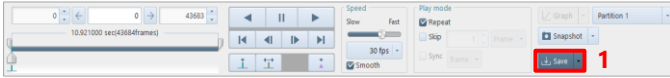

1. Click the [Save] button on the recording/playback panel.  
The [Save] screen is displayed.

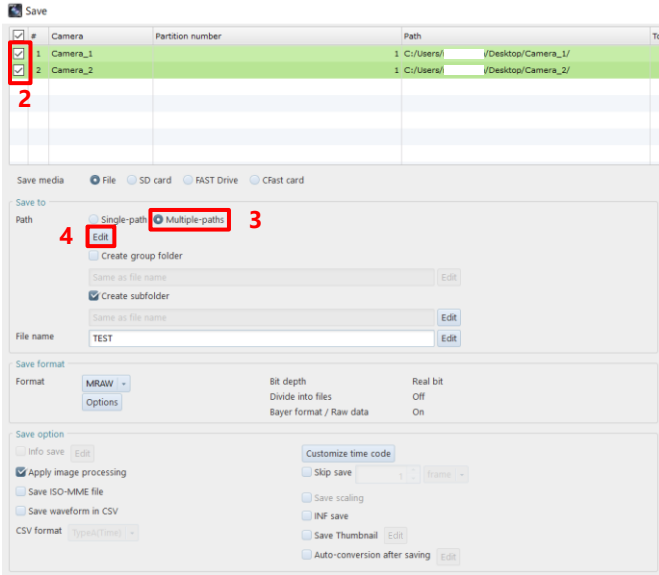

2. Check the [File].
3. Select the [Multiple-paths].
4. Click the [Edit] button of [Multiple-paths].

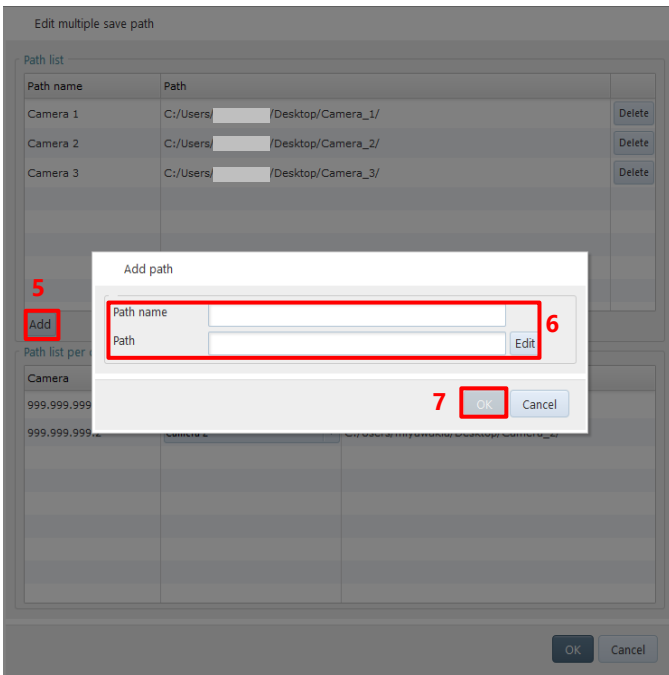

5. Click the [Add] button.
6. Specify the “Path name” and “Path”.
7. Click the [OK] button.

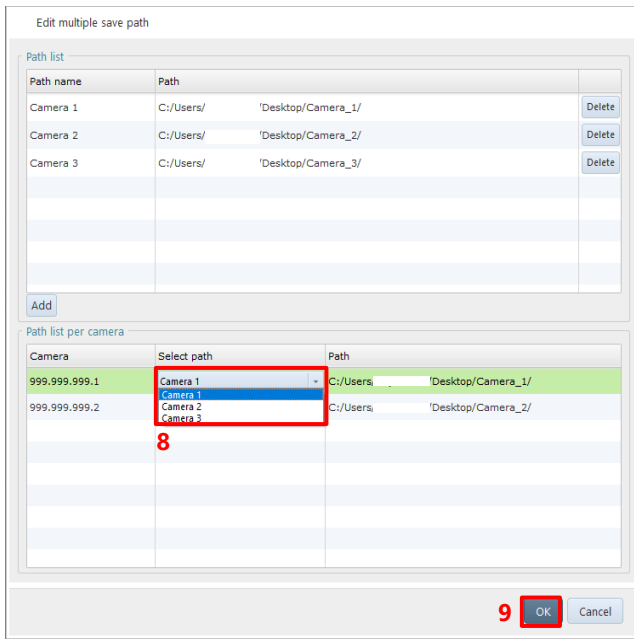

8. Select the “Path” from the path list for each camera.
9. Click the [OK] button.

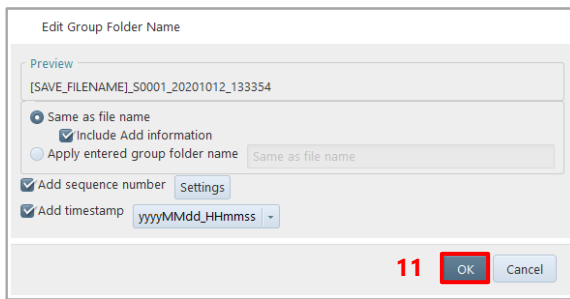

10. Configure the settings.
11. Click the [OK] button.

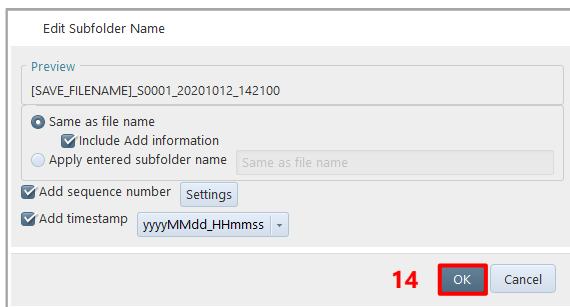

12. Click the [Edit] button of “Create subfolder”.
13. Configure the settings.
14. Click the [OK] button.

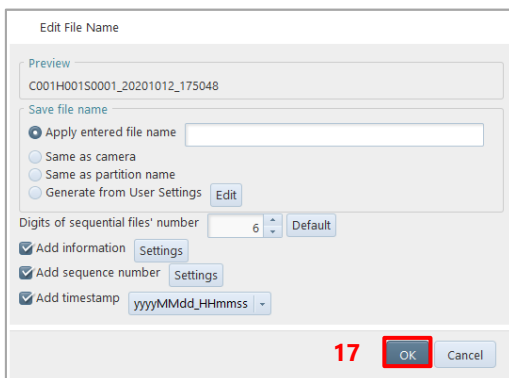

15. Click the [Edit] button of “File name”.
16. Configure the settings.
17. Click the [OK] button.

## 6.2.6. Saving Images to SD Card

Models supporting SD card connection can save image data to the SD card inserted in the camera.

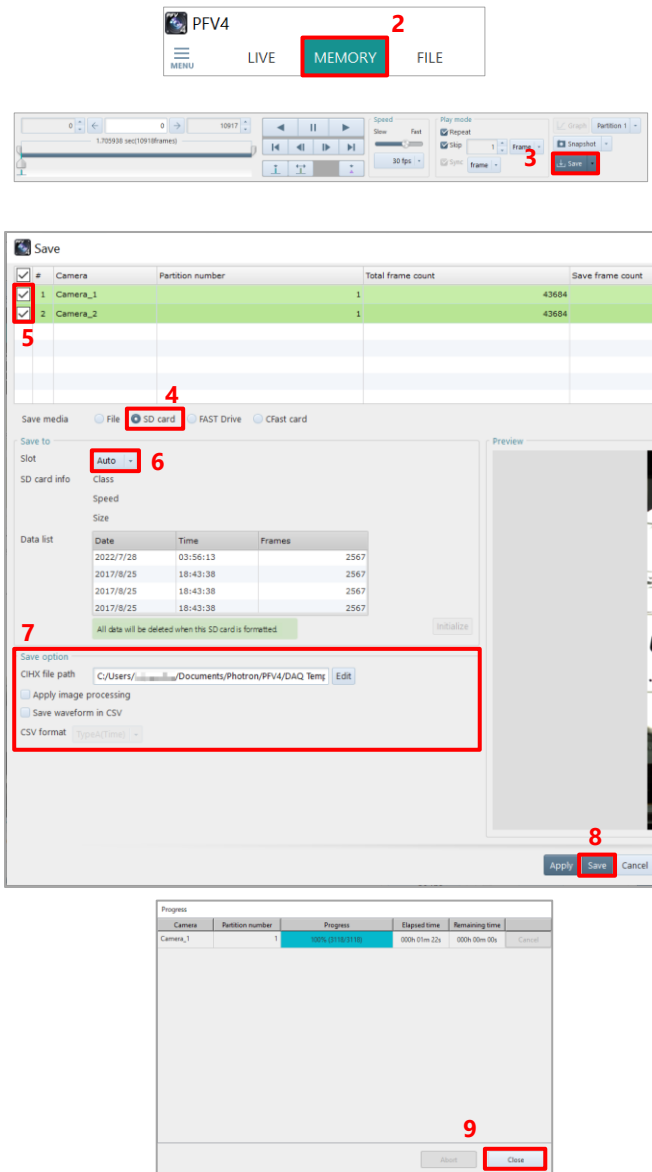

1. Set an SD card to the camera.
2. Click the [MEMORY] tab.
3. Click the [Save] button on the recording/playback panel. The [Save] screen is displayed.
4. Choose “SD Card”.
5. Check the file to save.
6. In “Slot”, select a slot where the SD card is connected. The information on the SD card is displayed in “SD card info”, and the list of data in the SD card is displayed on “Data list”.
7. Set “Save option”.
8. Click the [Save] button. When the saving process is complete, the saved data will be displayed in “Data list” in list form.
9. Click the [Close] button.

### NOTE

- If the SD card is unformatted, the [Save] button cannot be clicked. Click the [Initialize] button and then the [Yes] button on the displayed confirmation dialog to format the SD card.
- If the SD card is write-protected, the [Initialize] or [Save] button is not active. Eject the SD card, unlock the write protection, and reinsert it.

## 6.2.7. Saving Images to FAST Drive

Models supporting FAST Drive connection can save image data to the FAST Drive connected to the camera.

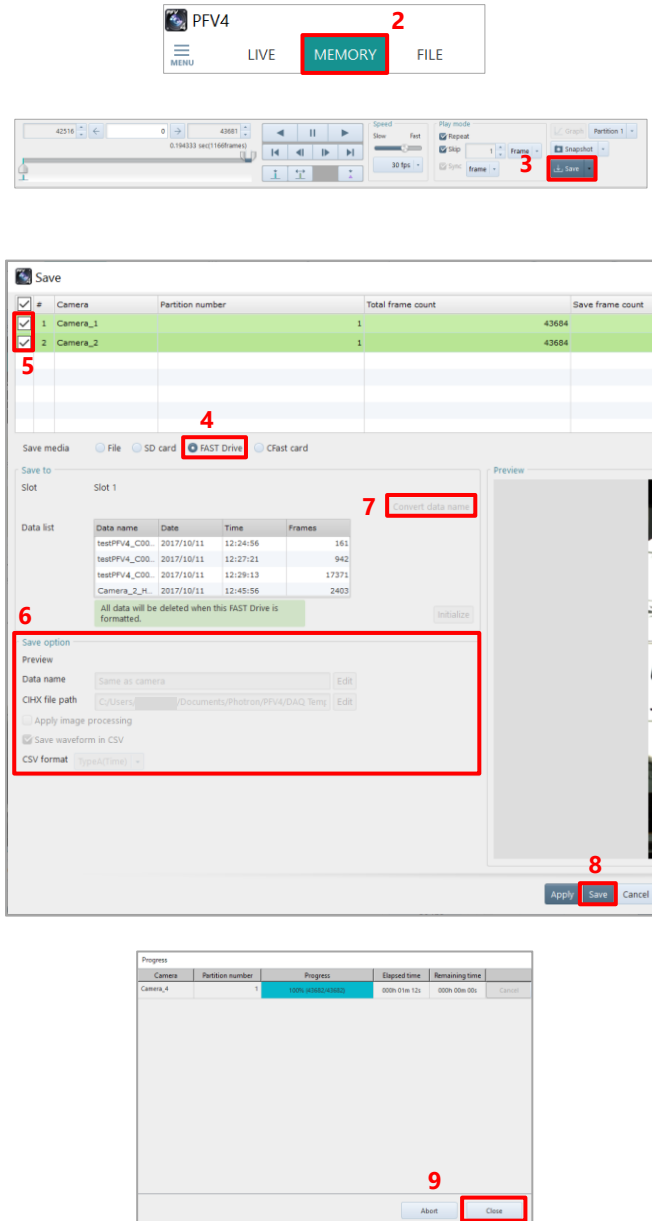

1. Connect the FAST Drive to the camera.
2. Click the “MEMORY” tab.
3. Click the [Save] button on the recording/playback panel. The [Save] screen is displayed.
4. Choose [FAST Drive]. The list of data in the FAST Drive is displayed on “Data list”.
5. Check the file to save.
6. Set “Save option”.
7. Click the “Convert data name” button to change the name of the data saved in FAST Drive.
8. Click the [Save] button. When the saving process is complete, the saved data will be displayed in “Data list” in list form.
9. Click the [Close] button.

### NOTE

- If the FAST Drive is unformatted, the [Save] button cannot be clicked. Click the [Initialize] button and then the [Yes] button on the displayed confirmation dialog to format the FAST Drive.
- Note that if “Enable hardware auto save” is checked in [MENU] - [Configuration] - [Save] and the data is automatically saved to FAST Drive after recording, no sequence number will be added to the data name of the saved data, even if “Add sequence number” is checked from the from the [Convert data name] button. To add a sequence number, uncheck "Enable hardware auto save" and save the data manually after recording.



## 6.2.8. Saving Images to CFast Card

Models supporting CFast card connection can save image data to the CFast card connected to the camera.

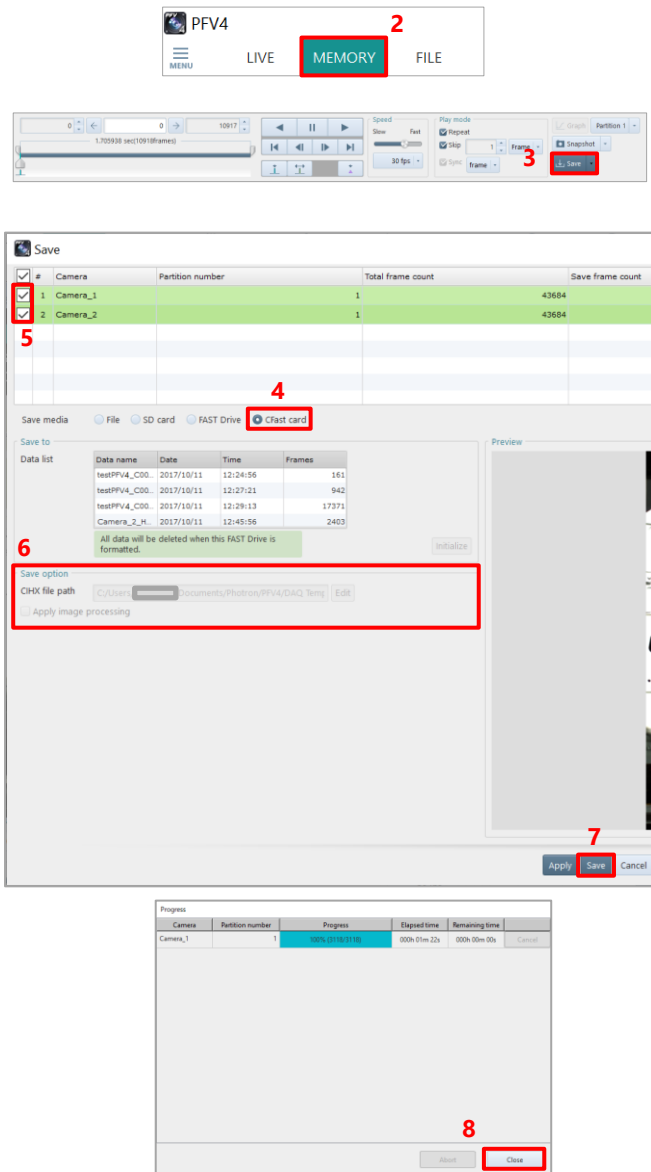

1. Connect the CFast card to the camera.
2. Click the [MEMORY] tab.
3. Click the [Save] button on the recording/playback panel. The [Save] screen is displayed.
4. Choose “CFast”.
5. Check the file to save.
6. Set “Save option”.
7. Click the [Save] button. When the saving process is complete, the saved data will be displayed in “Data list” in list form.
8. Click the [Close] button.

### REFERENCE

To use the CFast card, you need to make initial settings. For details of the initial settings, see the hardware manual of the camera.

## 6.2.9. File Formats and Options

In PFV, [Options] becomes active for the following file formats. When clicking it, you can make detailed settings.

Here, the formats to activate [Options] and the option settings are described.

TIFF, JPEG, PNG, RAWW, MRAW, GRAW, AVI, MOV, MP4

### TIFF

For TIFF, you can make the following settings on the screen to be displayed by clicking [Options].

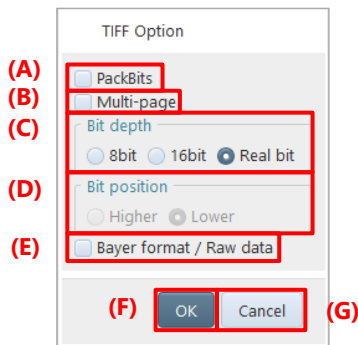

Item	Name	Function
(A)	PackBits	Checking this enables compression using run length encoding of PackBits algorithm.
(B)	Multi-page	Checking this enables storing the target frame in a single TIFF file. The file will be split up when data exceeds 2 GB.
(C)	Bit depth	Choose the bit depth of TIFF to output, from the following. <ul style="list-style-type: none"> <li>• 8bit</li> <li>• 16bit</li> <li>• Real bit</li> </ul>
(D)	Bit position	When the pixel data is less than 16 bits, choose higher order or lower order as a bit side to be given priority.
(E)	Bayer format / Raw data	Checking this enables bayer save.
(F)	OK	Applies the settings and closes this screen.
(G)	Cancel	Closes the screen without applying the changed settings.

## JPEG

For JPG, you can make the following settings on the screen to be displayed by clicking [Options].

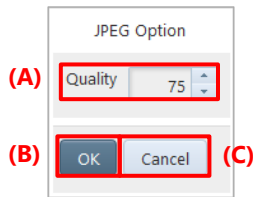

Item	Name	Function
(A)	Quality	Enter any value from 0 to 100 as the compression quality. The higher the value, the higher the quality.
(B)	OK	Applies the settings and closes this screen.
(C)	Cancel	Closes the screen without applying the changed settings.

## PNG

For PNG, you can make the following settings on the screen to be displayed by clicking [Options].

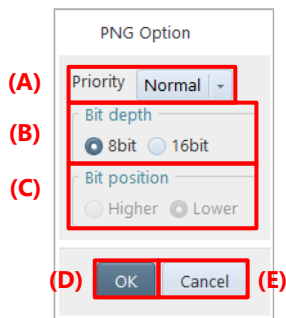

Item	Name	Function
(A)	Priority	Select the desired option from the list to be displayed by clicking. The list displays the following items. <ul style="list-style-type: none"> <li>• Normal</li> <li>• Speed: Choose this to increase the compression speed.</li> <li>• Size: Choose this to increase the compression rate.</li> </ul>
(B)	Bit depth	Choose the bit depth of PNG to output, from the following. <ul style="list-style-type: none"> <li>• 8bit</li> <li>• 16bit</li> </ul>
(C)	Bit position	When the pixel data is less than 16 bits, choose higher order or lower order as a bit side to be given priority.
(D)	OK	Applies the settings and closes this screen.
(E)	Cancel	Closes the screen without applying the changed settings.

## RAWW

For RAWW, you can make the following settings on the screen to be displayed by clicking [Options].

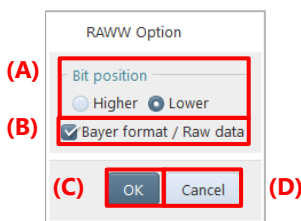

Item	Name	Function
(A)	Bit position	When the pixel data is less than 16 bits, choose higher order or lower order as a bit side to be given priority.
(B)	Bayer format / Raw data	Checking this enables bayer save.
(C)	OK	Applies the settings and closes this screen.
(D)	Cancel	Closes the screen without applying the changed settings.

## MRAW

For MRAW, you can make the following settings on the screen to be displayed by clicking [Options].

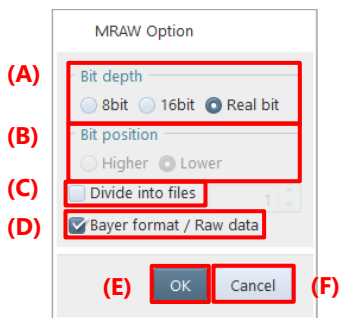

Item	Name	Function
(A)	Bit depth	Choose the bit depth of PNG to output, from the following. <ul style="list-style-type: none"> <li>• 8bit</li> <li>• 16bit</li> <li>• Real bit</li> </ul>
(B)	Bit position	When the pixel data is less than 16 bits, choose higher order or lower order as a bit side to be given priority.
(C)	Divide into files	Checking this will split up the file by the number of split frames in the numeral input box on the right. <div style="border: 1px solid orange; padding: 5px; margin-top: 10px;"> <p><b>NOTE</b></p> <p>The file branch number “-xx” is suffixed to the name of the split file.</p> </div>
(D)	Bayer format / Raw data	Checking this enables bayer save.
(E)	OK	Applies the settings and closes this screen.
(F)	Cancel	Closes the screen without applying the changed settings.

## GRAW

### NOTE

GRAW format:

- This is a save format that allows for faster downloads.
- You can select this option when you save from the memory of a camera that supports GRAW saving. When GRAW saving is not available, it will switch to MRAW saving.
- The recommended environment for saving is as follows  
Connect the camera via 10GbE (use a 10GbE network card and configure the 10GbE connection settings in the Ethernet settings).  
Save to a storage device with high write performance (M.2 SSD recommended).

For GRAW, you can make the following settings on the screen to be displayed by clicking [Options].

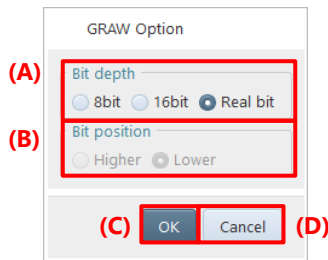

Item	Name	Function
(A)	Bit depth	Choose the bit depth of PNG to output, from the following. <ul style="list-style-type: none"><li>• 8bit</li><li>• 16bit</li><li>• Real bit</li></ul>
(B)	Bit position	When the pixel data is less than 16 bits, choose higher order or lower order as a bit side to be given priority.
(C)	OK	Applies the settings and closes this screen.
(D)	Cancel	Closes the screen without applying the changed settings.

## AVI

For AVI, you can make the following settings on the screen to be displayed by clicking [Options].

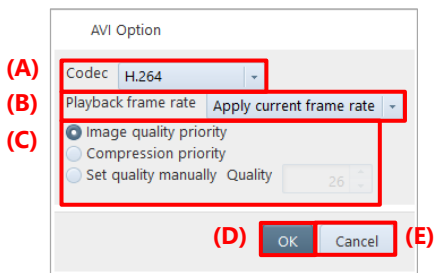

Item	Name	Function
(A)	Codec	Make a setting of encoder. Select an encoder to use from the list to be displayed by clicking.
(B)	Playback frame rate	Select a video frame rate to use from the list to be displayed by clicking. The selectable frame rates are 1 to 5, 10, 15, 20, 25, and 30.
(C)	Quality	Compression quality has three options. Enter any value from 0 to 100 for the compression quality, the higher value, the higher quality. Only when selecting “H.264” in (A) Codec, enter any value from 1 to 51 for the compression quality; the smaller value, the higher quality.
(D)	OK	Applies the settings and closes this screen.
(E)	Cancel	Closes the screen without applying the changed settings.

## MOV

For MOV, you can make the following settings on the screen to be displayed by clicking [Options].

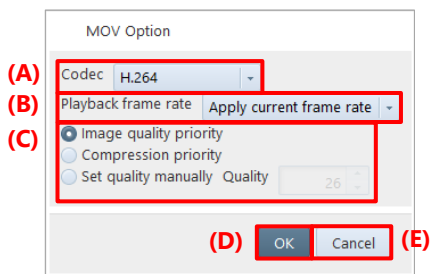

Item	Name	Function
(A)	Codec	Make a setting of encoder. Select an encoder to use from the list to be displayed by clicking.
(B)	Playback frame rate	Select a video frame rate to use from the list to be displayed by clicking. The selectable frame rates are 1 to 5, 10, 15, 20, 25, and 30.
(C)	Quality	Compression quality has three options. Enter any value from 1 to 51 for the compression quality; the smaller value, the higher quality.
(D)	OK	Applies the settings and closes this screen.
(E)	Cancel	Closes the screen without applying the changed settings.

## MP4

For MP4, you can make the following settings on the screen to be displayed by clicking [Options].

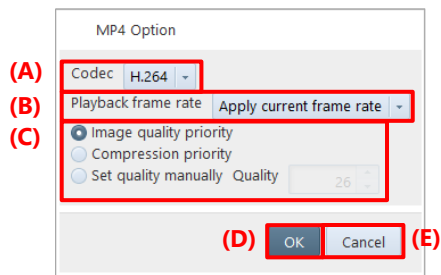

Item	Name	Function
(A)	Codec	Make a setting of encoder. Select an encoder to use from the list to be displayed by clicking.
(B)	Playback frame rate	Select a video frame rate to use from the list to be displayed by clicking. The selectable frame rates are 1 to 5, 10, 15, 20, 25, and 30.
(C)	Quality	Compression quality has three options. Enter any value from 1 to 51 for the compression quality; the smaller value, the higher quality.
(D)	OK	Applies the settings and closes this screen.
(E)	Cancel	Closes the screen without applying the changed settings.

## 6.2.10. Save Options

Here, option items that can be set during file save are described.  
To apply the settings, click the [Save] button.

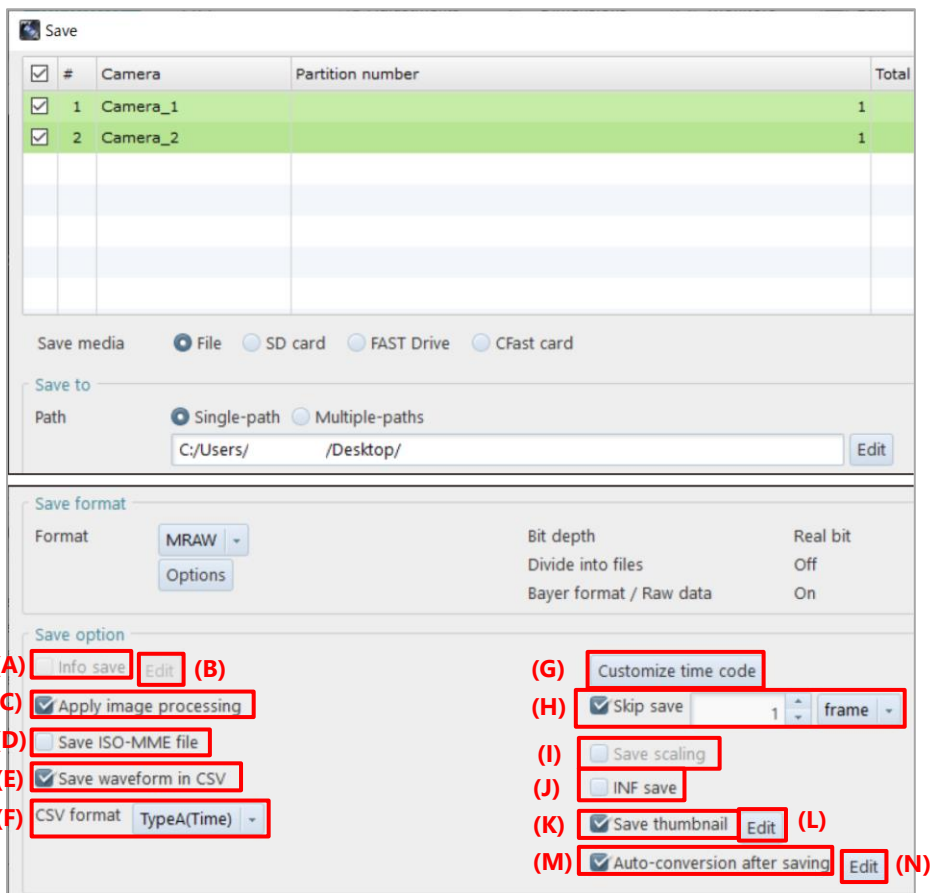

Item	Name	Function
(A)	Info save	The save information feature allows you to add shooting information, such as a frame rate, and a comment to the file to save. However, when you save the file in bayer format, information or a comment cannot be included in it. The details of the information to save can be set on the [Edit Display Info] screen to be displayed by clicking the [Edit] button.
(B)	Edit	Checking “Info save” and then clicking the [Edit] button displays the [Edit Display Info] screen. On this screen, check the information to save.
(C)	Apply image processing	Checking this will have the image processing such as LUT, Pseudo Color, Keystone Correction, etc. applied to the saved data as well.
(D)	Save ISO-MME file	Checking this enables saving in ISO-MME format.
(E)	Save waveform in CSV	Checking this enables saving a waveform data in CSV format.
(F)	CSV format	Select the CSV format. For details of format, see the “A4 CSV File” on page 334.
(G)	Customize time code	Checking this allows you to customize the number of time code digits to be displayed on the video display region during playback.



<b>Item</b>	<b>Name</b>	<b>Function</b>
(H)	Skip save	Checking this will skip images by the desired number of frames before save.
(I)	Save scaling	Checking this enables the images scaled on the video display region to be saved at this scaling rate. The scaling rate can be checked in the view window information.
(J)	Save INF	Checking this enables saving an INF file together with the information to be saved.
(K)	Save Thumbnail	Checking this enables saving the triggered frame in JPG format.
(L)	Edit	Click this to edit the text to be added to the end of the file name of the triggered frame image saved by Save Thumbnail.
(M)	Auto-conversion after saving	Checking this enables auto-conversion after saving data according to the settings in (N) Edit.
(N)	Edit	Click this to edit auto-conversion settings. For details, see the “6.1 File Save Settings” on page 111.

## 6.2.11. Save Information Settings

Here, the setting of the [Edit Display Info] screen to be displayed for the save information feature is described.

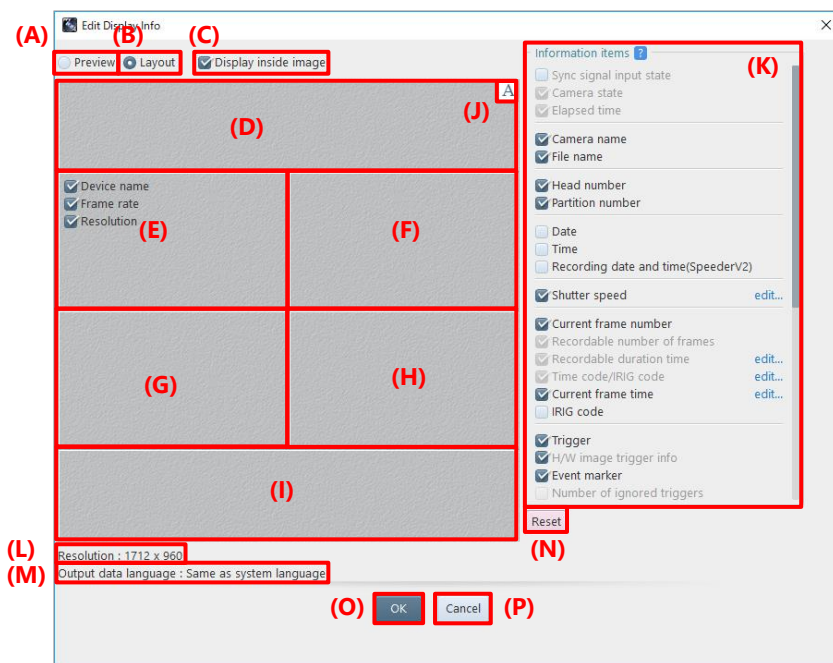

Item	Name	Function
(A)	Preview	Choosing this displays the preview screen.
(B)	Layout	Choosing this displays the layout screen.
(C)	Display inside image	Displays information inside the image.
(D)	List of items to be placed at the top	Allows you to show/hide the items to be drawn in each part of the screen. You can change the order by dragging them. Moreover, you can add items from the item list by a drag-and-drop operation. You can also return them to the item list by the drag-and-drop operation. They can also be moved directly among divisions. When the number of items increases, the scrollbar will be displayed automatically.
(E)	List of items to be placed at the upper left part	
(F)	List of items to be placed at the upper right part	
(G)	List of items to be placed at the lower left part	
(H)	List of items to be placed at the lower right part	
(I)	List of items to be placed at the bottom	

Item	Name	Function
(J)	Formatting	Displays the [Edit Format] screen for each arrangement. Placing the cursor over an item in each part will show buttons, then click them to display the setting screen.
(K)	Information items	Displays the list of selectable items. The items arranged in each part to the left are not displayed on this list.
(L)	Resolution	Displays the final resolution of the on-screen image.
(M)	Output language	Displays the language used in the file to be saved.
(N)	Reset	Returns the settings to default.
(O)	OK	Applies the settings and closes this screen.
(P)	Cancel	Closes the screen without applying the changed settings.

### ■ When [Preview] is selected

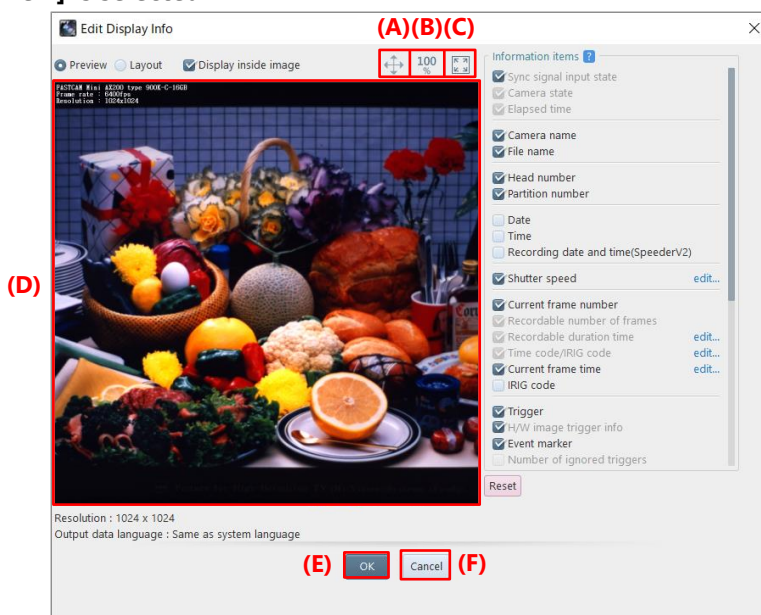

Item	Name	Function
(A)		Clicking this changes the icon to , which allows you to move the displayed image by dragging it.
(B)		Clicking this restores the resolution of the original image.
(C)		Clicking this fits the image to the screen.
(D)	Preview area	Displays the image having the items arranged on the layout screen.
(E)	OK	Applies the settings and closes this screen.
(F)	Cancel	Closes the screen without applying the changed settings.

**[Edit Format] screen for save information feature**



Item	Name	Function
(A)	Auto set	Checking this will apply the following settings to other positions at once.
(B)	Font selection	Select a font to use from the list to be displayed by clicking.
(C)	Font size	Select a font size to use from the list to be displayed by clicking.
(D)	Bold	Clicking this will put the font in bold.
(E)	Italics	Clicking this will put the font in italic.
(F)	Font color	Clicking this displays the screen on which to select a color, where you can select a color to use.
(G)	Fix font size ratio	Checking this will fix the font size ratio.
(H)	Alignment	Select a display width from among (align left), (align center), and (align right).
(I)	Use background color	Clicking this allows you to color the background of information display.
(J)	Background color	Clicking this displays the screen on which to select a color, where you can select a color to use.
(K)	Display width	Set the width of information display by entering a value.
(L)	Enable	Checking this enables column composing.
(M)	Column number	Specify the number of columns. You can use the value from 2 to 10.
(N)	Column spacing	Specify the width between columns. You can use the value from 1 to 9999.
(O)	OK	Applies the settings and closes this screen.
(P)	Cancel	Closes the screen without applying the changed settings.



**NOTE**

If characters are changed to bold or italic, the layout might be slightly collapsed.

## 6.3. Saving Layout

You can make a composite video from those shot with multiple cameras and heads and then save the file. You can also save the waveform data together.

### ⚠ CAUTION

- For layout save, the CIHX file is not created.
- The maximum resolution size that PFV can save is 8,196 x 8,196. If data is saved in a high resolution in layout save mode, software other than PFV may fail to playback the saved data.

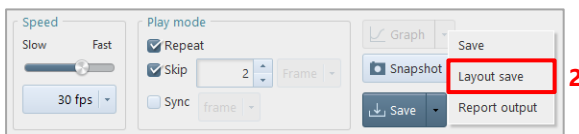
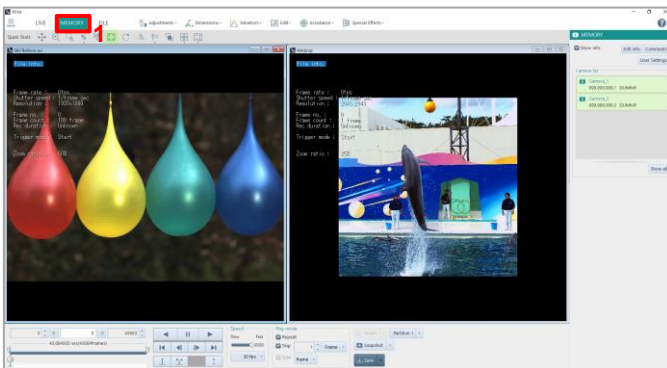
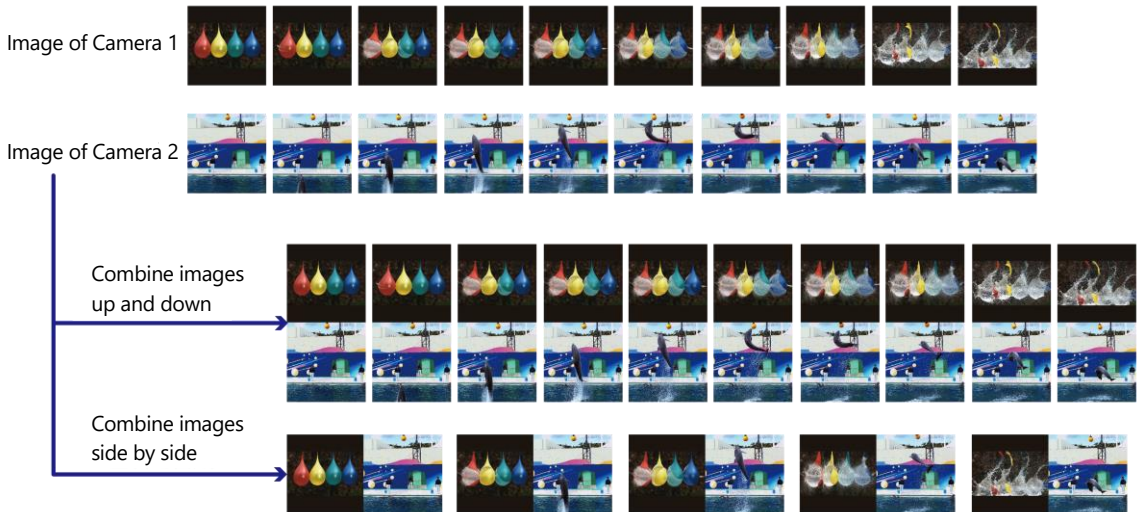

1. Display the target recorded data for layout save.

2. Click [▼] to the right of the [Save] button on the recording/playback panel, and click [Layout save].

The layout save dialog is displayed, and the data selected in step 1 and their images are displayed on the window list and the preview respectively.

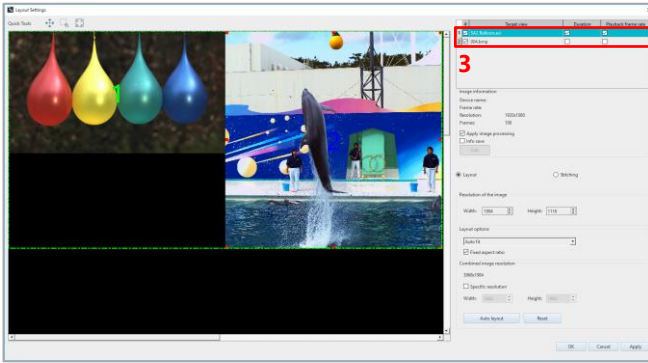

3. Select image data of which you will edit the information.

Select image data from among the window list or preview.

The number on the selected image in preview will be highlighted with yellow-green, and that in window list, light blue. The information of the said image will be displayed in “Image information” and “Resolution of the image”.

### NOTE

- By checking/unchecking the box at the head of each data, you can select the target data for layout save.
- If cameras, numbers of files, and resolutions are the same as the dialog was opened last time, the settings in the dialog will be shown the same as the last time.

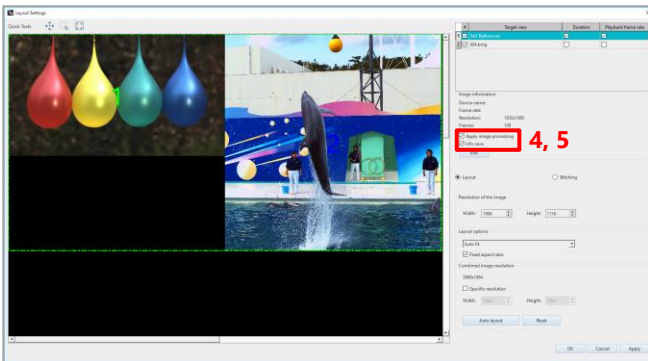

4. To apply the image processing that is applied to the selected image also to save it, check “Apply image processing”.

5. To save the video information on the selected image, check “Info save”.

The details of the information to save can be set on the [Edit Display Info] screen to be displayed by clicking the [Edit] button.

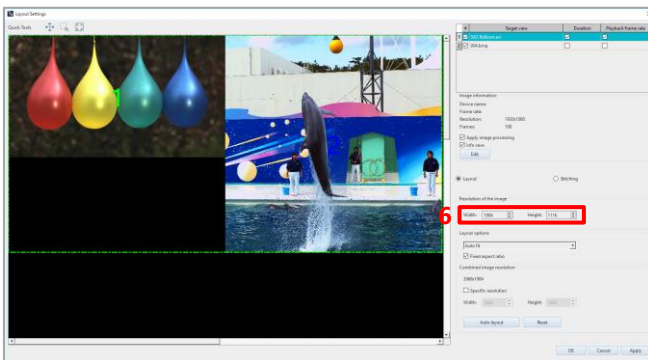

6. In “Resolution of the image”, set the resolution of the selected image.

7. For other images, repeat steps 3 to 6 as necessary.

### NOTE

- You can set the individual resolution for the current target data for layout save (the data whose box at its head is checked).
- You can also resize the image on the preview to set the resolution.

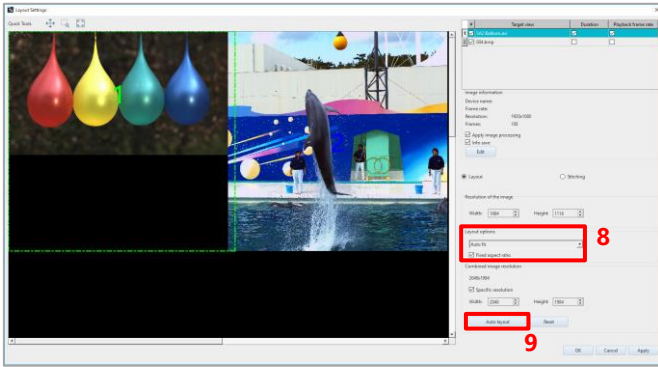

8. In “Layout options”, select how to join the images overlapping on the preview from the following.

- Auto fit: Joins them to all the sides altering the size of the image according to the overlapping state.
- Auto alignment: Joins them to all the sides without altering the size of the image according to the overlapping state.
- Manual: Keeps them overlapped.

If you select “Auto fit”, check “Fixed aspect ratio” as necessary.

9. To set the desired joint resolution, check “Specific resolution” and specify the width and height.

The images corresponding to the specified resolution are displayed on the preview.

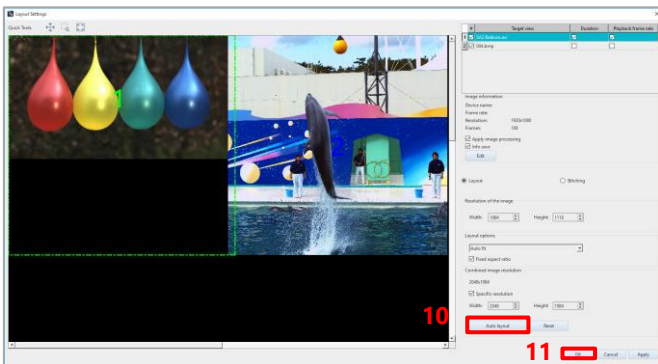

10. Drag each image on the preview to set the layout.

The preview can be zoomed in/out by rotating the mouse wheel.

When you click the [Auto layout] button, all the images will be aligned and resized optimally with the aspect ratio maintained.

11. Click the [OK] button.

12. Specify the destination folder.

Clicking the [Edit] button displays the [Select folder] screen, where you can make detailed settings.

13. Specify the filename.

Clicking the [Edit] button displays the [Edit File Name] screen, where you can make detailed settings.

14. Click the [Save] button.

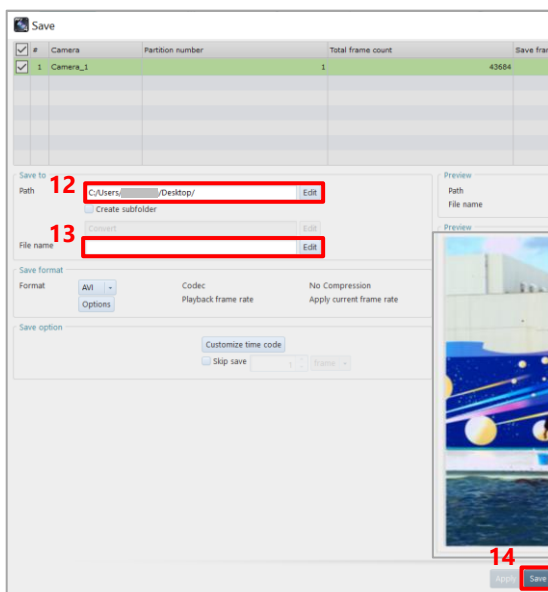





## REFERENCE

- For how to display the data, see “5.2 Playing Back Recorded Data” on page 100.
- For how to display the waveform input data, see “8.7.1 DAQ Control” on page 234.
- For usual save method, see “6.2 Saving Recorded Data” on page 113.

### ■ Stitching

This feature synthesizes a panoramic image by stitching images together.

Combining processing will be performed in the order of files shown in the file list, thus the resulting image will differ depending on the order of files in the list.

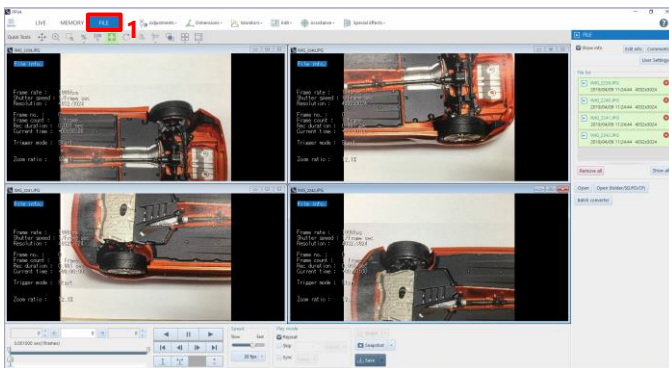
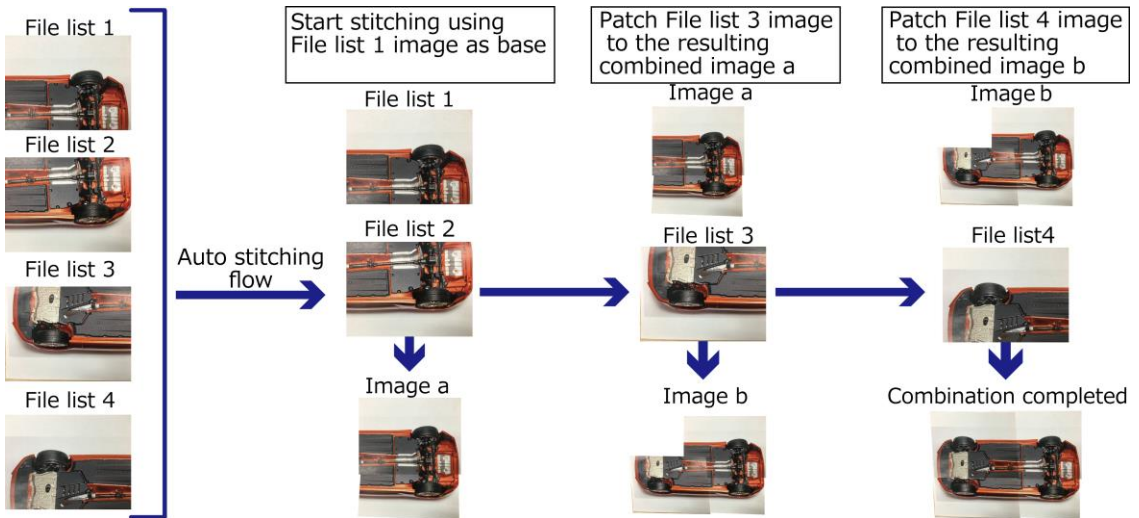

1. Display the target recorded data for layout save.

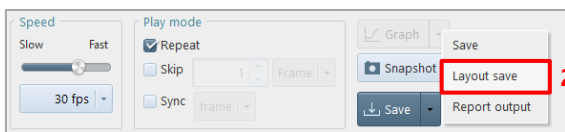

2. Click [▼] to the right of the [Save] button on the recording/playback panel, and click [Layout save].

The layout save dialog is displayed, and the data selected in step 1 and their images are displayed on the window list and the preview respectively.



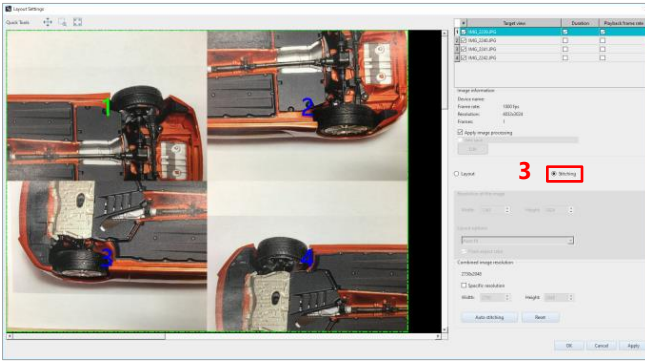

3. Select [Stitching].

**NOTE**

- By checking/unchecking the box at the head of each data, you can select the target data for layout save.
- If cameras, numbers of files, and resolutions are the same as the dialog was opened last time, the settings in the dialog will be shown the same as the last time.

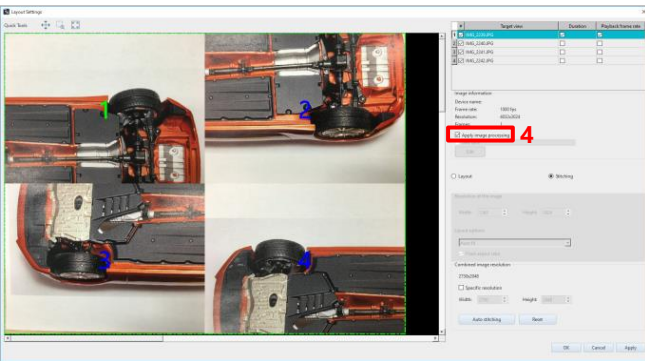

4. To apply the image processing that is applied to the selected image also to save it, check “Apply image processing”.

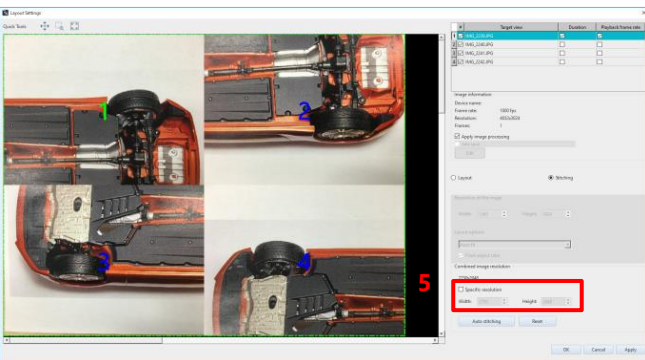

5. To set the desired joint resolution, check “Specific resolution” and specify the width and height. The images corresponding to the specified resolution are displayed on the preview.

**NOTE**

You can also resize the image on the preview to set the resolution.

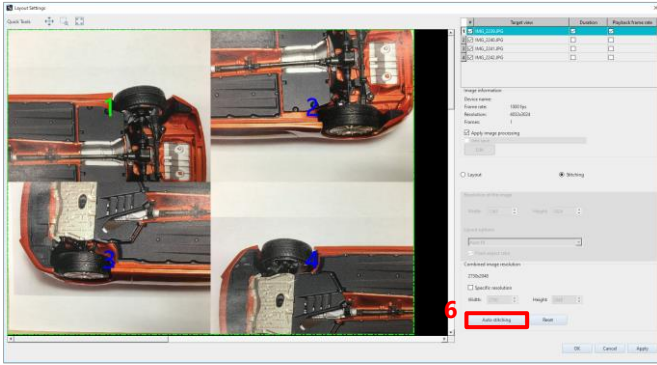

- To stitch manually, drag each image on the preview to set the layout.  
The preview can be zoomed in/out by rotating the mouse wheel.  
When you click the [Auto stitching] button, all the images will be combined.

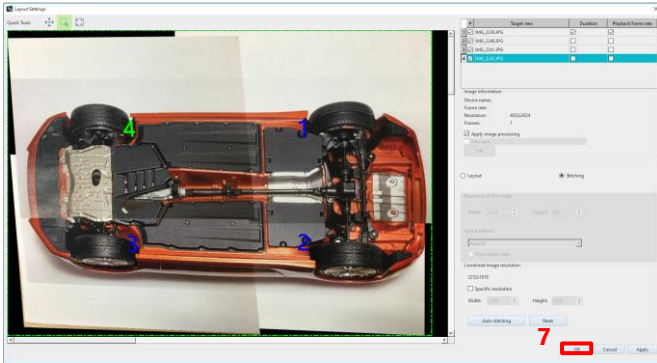

- Click the [OK] button.

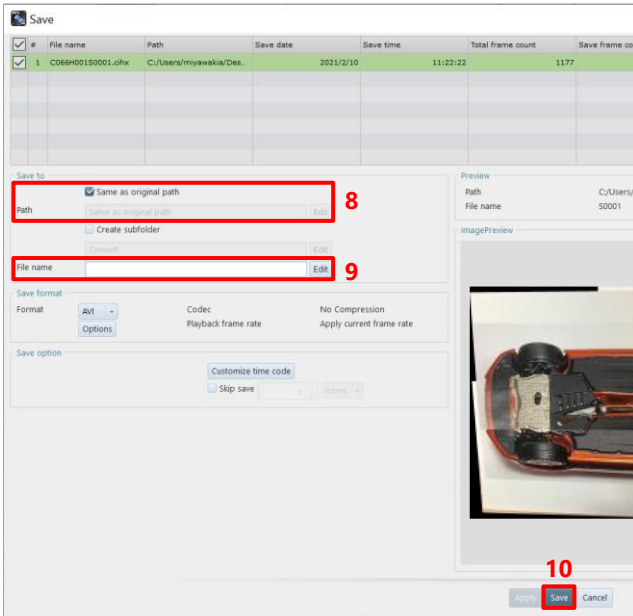

- Specify the destination folder.  
Clicking the [Edit] button displays the [Select folder] screen, where you can make detailed settings.
- Specify the file name.  
Clicking the [Edit] button displays the [Edit File Name] screen, where you can make detailed settings.
- Click the [Save] button.

When an error is given and auto-stitching cannot be performed, check the image to be processed based on the following points.

Error	Description
Feature points could not be extracted from the image of {file name}.	There is no detected feature point.
Not enough feature points are matched between {file name} and {file name}.	There is no result of matching.
{file name} and {file name} are the identical image.	Stitching was processed among identical images.
The resolution of {file name} became too large.	Resolution size (width or height) resulting from stitching becomes three times larger or even more than the original resolution.
The combined resolution became too large.	Resolution size (width or height) resulting from stitching becomes larger than the maximum resolution size (8,196 x 8,196).
The image could not be transformed appropriately.	The result image from stitching is inverted, although the resolution size is within the maximum size.

**NOTE**

- Template Function

Layout settings can be saved and loaded as templates.

When you often need to save a specific layout or other fixed settings, saving the settings as a template allows for smooth application of the settings.

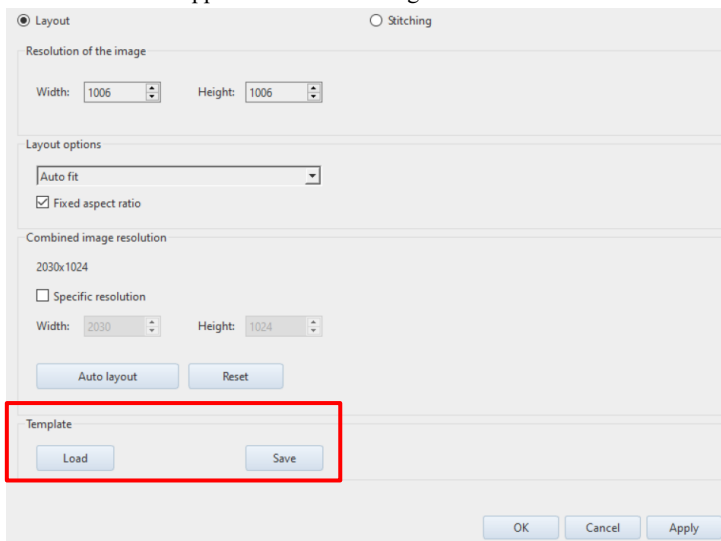

## 6.4. Outputting a Report

Image files opened in FILE mode and numerical shooting information such as a frame rate can be output to a prepared Excel, Word, or PowerPoint template.

To use this function, Microsoft Office 2010 or later (Excel, Word, or PowerPoint) must be installed. For the template rules, see “6.4.1 Report Key List” on page 147. The procedure to output a report is as follows.

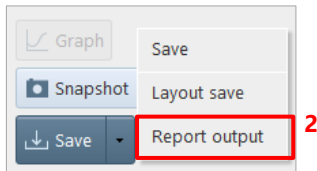

1. Display a video file to be output to a report in FILE mode.
2. Click [▼] of the [Save] button on the recording/playback panel, and click [Report output].

The “Report output” dialog is displayed. Data selected in step 1 and its image are displayed in the window list and “Preview”.

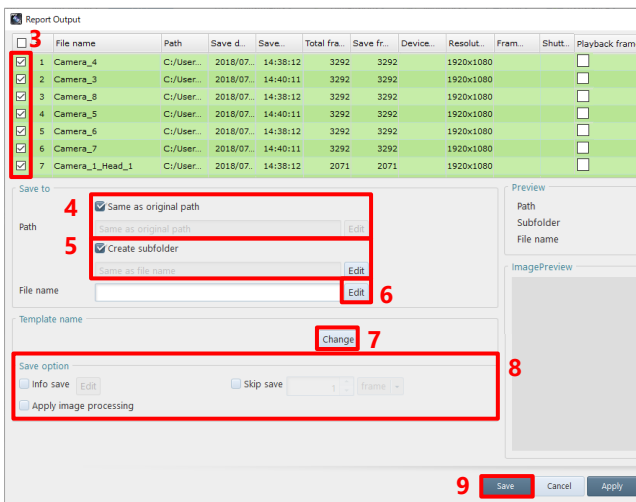

3. Check the file to save.
4. Specify the destination folder. Uncheck the [Same as original path] and click the [Edit] button to display the [Select folder] screen, where you can make detailed settings.
5. Create the subfolder. Clicking the [Edit] button displays the [Edit Subfolder Name] screen, where you can make detailed settings.
6. Specify the filename. Clicking the [Edit] button displays the [Edit File Name] screen, where you can make detailed settings.
7. Click the [Change] button and select the template corresponding to the desired file format.
8. Set “Save option”.
9. Click the [Save] button.

### NOTE

Sample report templates are stored in the DVD.

Optional report settings are described below. The settings are displayed on the preview pane in the right part of the screen. To apply the settings, click the [Apply] button.

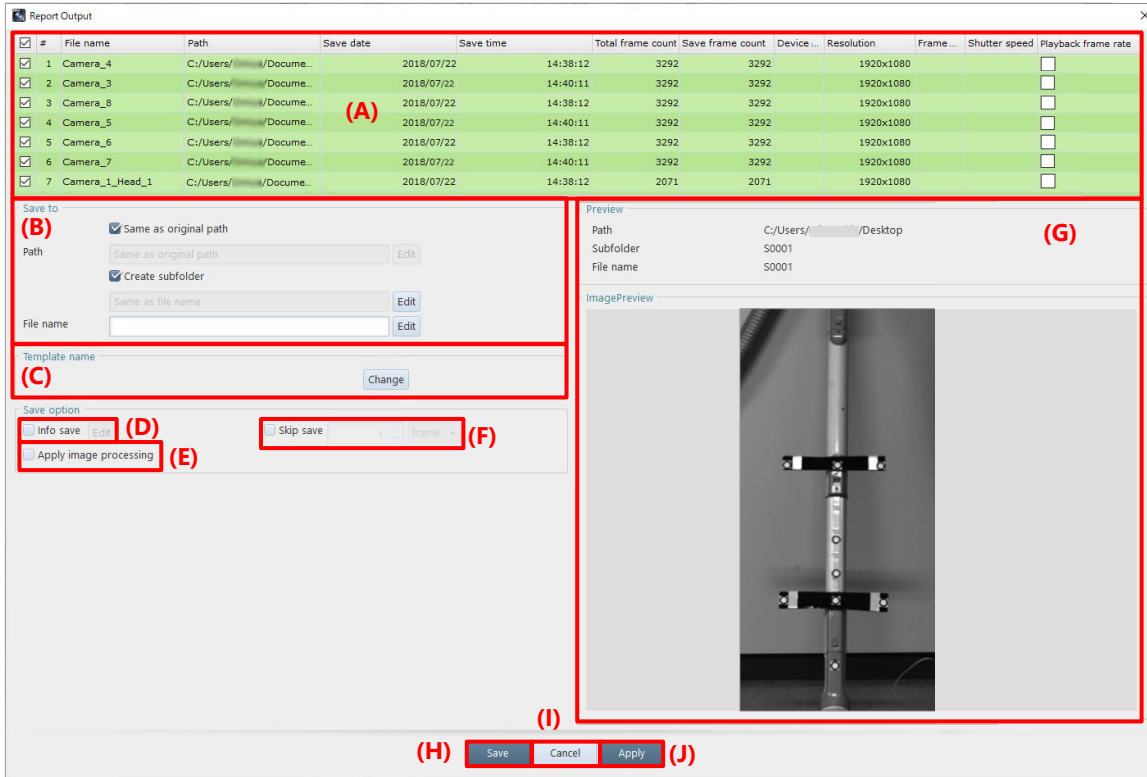

Item	Name	Function
(A)	File list	Check the target file for save. When outputting a report of multiple files with time synchronization, check the “Playback frame rate” of the file to be used as the reference. For details, refer to the note on the next page.
(B)	Save to	Specify the destination path and filename. Clicking the [Edit] button of “Path” displays the “Select folder” dialog. Clicking the [Edit] button of “Create subfolder” displays the “Edit Subfolder Name” dialog. Clicking the [Edit] button of “File name” displays the “Edit File Name” dialog.
(C)	Template name	Click the [Change] button and select a template file to use for saving data.
(D)	Info save	The info save feature allows you to add recording information, such as a frame rate, and a comment to the file to save. Check “Info save” and then click the [Edit] button to display the [Edit Display Info] screen. On this screen, check the information to save.
(E)	Apply image processing	Checking this will restore the last image processing before save.
(F)	Skip save	Checking this will skip images by the specified number of frames or the specified time. The trigger frame is not skipped. For details, see “5.3.8 Skip Playback” on page 107.
(G)	Preview	Displays the image in the file to be saved.
(H)	Save	Applies the settings, saves the file, and closes this screen.
(I)	Cancel	Closes the screen without applying the changed settings.
(J)	Apply	Applies the settings and closes this screen. The file will not be saved.



## NOTE

When synchronizing files with different frame rates and outputting report:

- There will be a time gap because the frame numbers are specified from the beginning. In such a case, check the “Playback frame rate” of the reference file and output.
- The unit for skip saving is fixed to "msec".
- The key for image embedding is specified by [image\_(image number)\_(frame number)].

Example: In the case of files recorded at 1,000 fps and 2,000 fps

### When a file with a slower frame rate is set as the synchronization standard

Output key	Time	Actual frame of file 1 (1,000 fps) *Standard	Actual frame of file 2 (2,000 fps)
image_x_1	0.000	frame 1	frame 1
image_x_2	0.001	frame 2	frame 3
image_x_3	0.002	frame 3	frame 5
image_x_4	0.003	frame 4	frame 7
image_x_5	0.004	frame 5	frame 9
image_x_6	0.005	frame 6	frame 11
image_x_7	0.006	frame 7	frame 13

### When a file with a faster frame rate is set as the synchronization standard

Output key	Time	Actual frame of file 1 (1,000 fps)	Actual frame of file 2 (2,000 fps) *Standard
image_x_1	0.000	frame 1	frame 1
image_x_2	0.0005	frame 1	frame 2
image_x_3	0.001	frame 2	frame 3
image_x_4	0.0015	frame 2	frame 4
image_x_5	0.002	frame 3	frame 5
image_x_6	0.0025	frame 3	frame 6
image_x_7	0.003	frame 4	frame 7

## 6.4.1. Report Key List

For the information and keys that are output as shooting information, see the following table and the report output samples in the DVD.

An image must be a shape including a key name.

The basic format is as follows:

[(character string indicating a key) (image number)]

Example for outputting a device name: [devicename\_1]

When each frame has different information, the format is as follows:

[(character string indicating a key) (image number) (frame number)]

Example for outputting a current frame time: [currentframetime\_1\_3]

Information Item to Save	Key	Different Information for Each Frame	Remark
Device name	[devicename]		
Date	[date]		
Time	[time]		
Recording data and time	[recordingdatetime]		
Frame rate	[framerate]		
Shutter speed	[shutterspeed]		
Resolution	[resolution]		
Current frame number	[currentframe]	✓	
Recordable number of frames	[recordableframes]		
Recordable duration time	[recordabletime]		
Current frame time	[currentframetime]	✓	
Current frame time (ms)	[currentframetimems]	✓	
IRIG code	[irigcode]	✓	
Trigger	[trigger]		
Event marker	[event]	✓	
Number of ignored triggers	[ignoretrg]		
LUT	[lut]		
Saturation	[saturation]		
Zoom ratio	[zoomratio]		
Cross cursor	[crosscursor]	✓	
Comments	[comments]		
User settings	[usersetting1], [usersetting2] ...		Numbers are assigned to the user settings in ascending order.
Trigger to exposure gap time	[trgexp]	✓	
Measurements	[measurements]	✓	In the case of multiple results, all of them are output.

## 6.5. Saving/Copying a Snapshot Image

An image (snapshot image) displayed on the selected camera can be saved in a file or copied and pasted to the clipboard. When saving an image to a file, the currently displayed images of all the selected cameras and files are saved. When copying an image (and pasting it to the clipboard), only the currently active image is copied.

### NOTE

When copying a snapshot image (to be pasted to the clipboard), the image format is RGB888 for a color image and Indexed8 for a black and white image.

To save a snapshot image, set the saving method in advance by selecting [Snapshot] - [Snapshot Settings] on the recording/playback panel.

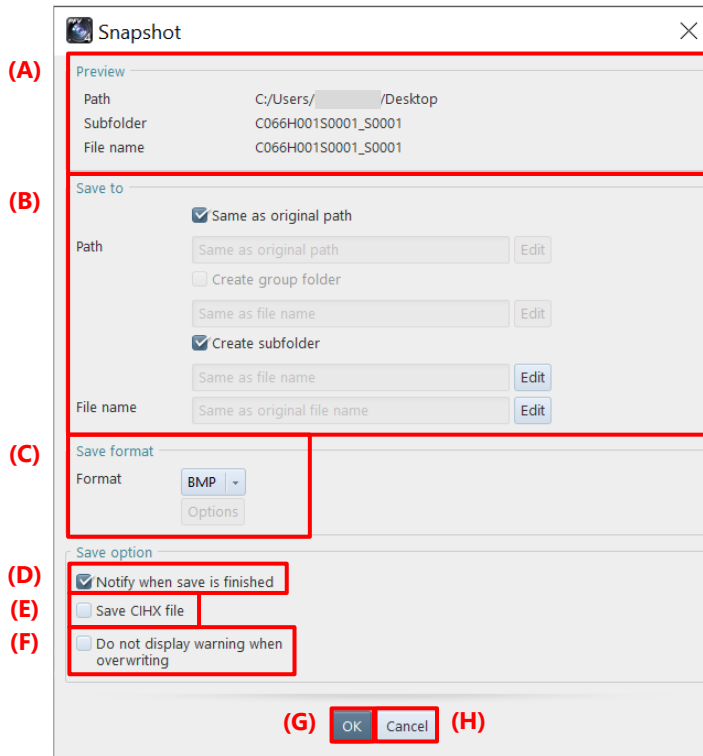

Item	Name	Function
(A)	Preview	Displays a preview of the destination and file name of the file to be saved as set in (B).
(B)	Save to	Specify the destination path and filename. Clicking the [Edit] button of "Path" displays the "Select folder" dialog. Clicking the [Edit] button of "File name" displays the "Edit File Name" dialog to make detailed settings.
(C)	Save format	Choose the format in which to save a snapshot image. Clicking the [Options] button allows you to make detailed settings. The setting items vary with the file format. For details, see "6.2.9 File Formats and Options" on page 126.



Item	Name	Function
(D)	Notify when save is finished	Selecting this check box displays a message when saving a snapshot image is complete.
(E)	Save CIHX file	Selecting this check box also saves a CIHX file when saving a snapshot.
(F)	Do not display warning when overwriting	When the box of this item is checked, the warning message will not be displayed in overwrite saving.
(G)	OK	Applies the settings and closes this screen.
(H)	Cancel	Closes the screen without applying the changed settings.

The procedure to save or copy a snapshot image is as follows.

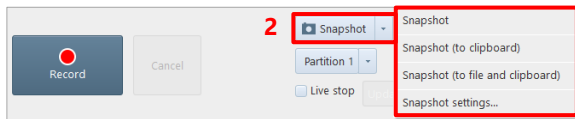
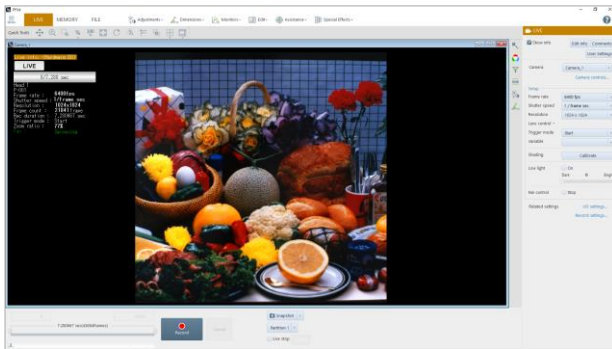

1. Display an image whose snapshot you want to save.

2. Click [▼] to the right of the [Snapshot] button on the recording/playback panel and select any of the following from the displayed list.

- Snapshot: Select this to save the currently displayed image of the selected camera or file in a file.
- Snapshot (to clipboard): Select this to copy the image being displayed on the currently active window to the clipboard.
- Snapshot (to file and clipboard): Select this to perform the above [Snapshot] and [Snapshot (to clipboard)] operations together.

3. A message is displayed. Then, click the [Yes] button.

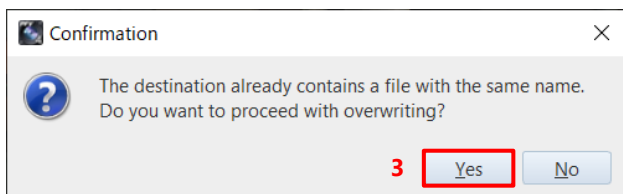

A confirmation message may be displayed depending on the selected menu or setting. Operate according to the displayed message. A snapshot image is saved in a file or copied to the clipboard.

# 7

## Chapter 7 Playing Back and Controlling Saved Data

This chapter describes how to play back the data files saved in the PC, data conversion, and others.

# 7.1. Playing Back Data Saved in PC

Here, how to play back saved image data is described.

To play back data, open the CIH or the CIHX file created when the data is saved.

You can also open the image file directly.

## 7.1.1. Opening Saved Data

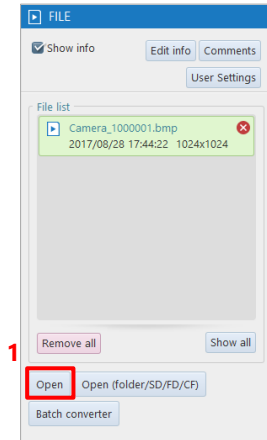

1. Click the [Open] button on the function panel.

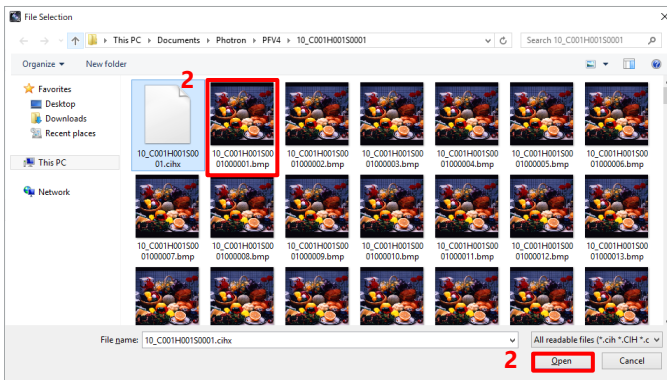

2. Select a file to play back and click the [Open] button.

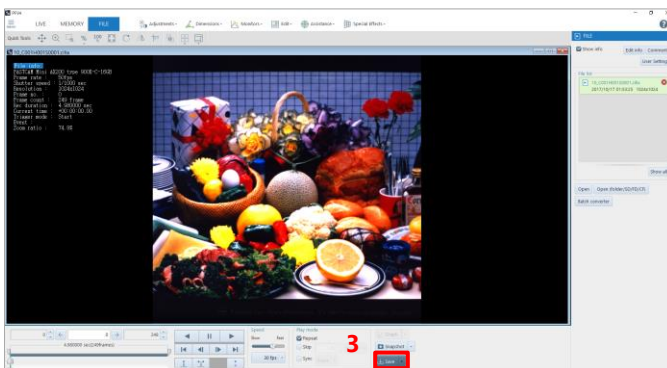

3. The data is displayed.  
You can play it back by clicking the [Play] button.



## CAUTION

You cannot directly open the file in RAWW or MRAW format. For the RAWW or MRAW file saved by using PFV, select and open the CIH or CIHX file on PFV.



## NOTE

- The available file formats are as follows:  
BMP, TIFF, JPEG, PNG, AVI, WMV, MP4, MOV, RAWW, MRAW, GRAW, CSV, CIH, CIHX, INF, and ISO-MME (Rev. 1.x)
- For CIH and CIHX files, you can open the files by double-clicking the file icon.  
For CIHX files, even if PFV4 is not started, data can be opened by double-clicking the file.
- You can open files in above formats by dragging and dropping.
- The view window can be closed by clicking [×] in the upper-right part.
- When you open the CIH or CIHX file, the shooting information appears.  
To hide it, select [FILE] in “Mode switching” tab to display the function panel and uncheck “Show info”.

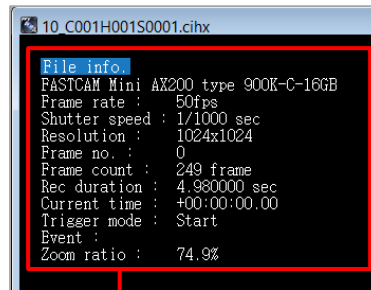
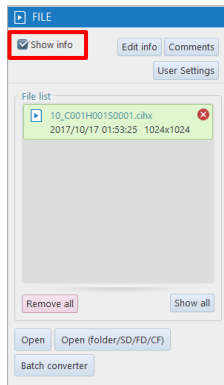

Shooting information

- Frame rate can be specified when opening files other than CIHX.  
When to open files other than CIHX, a set up dialog will appear. Type a desired numerical value and press the [OK] button.  
\*The setting of the frame rate can be specified only when opening the file. It cannot be specified later on.

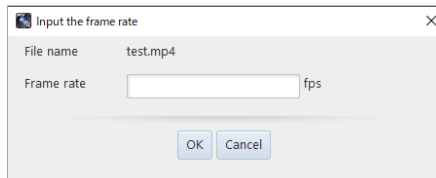

## REFERENCE

The recording/playback panel and the function panel allow you to play back data and make display settings as desired. For details, see “5.2 Playing Back Recorded Data” on page 100.

## 7.1.2. Opening Multiple Saved Data

To play back multiple data, select multiple files on the [File Selection] screen to be displayed after clicking the [Open] button on [FILE].

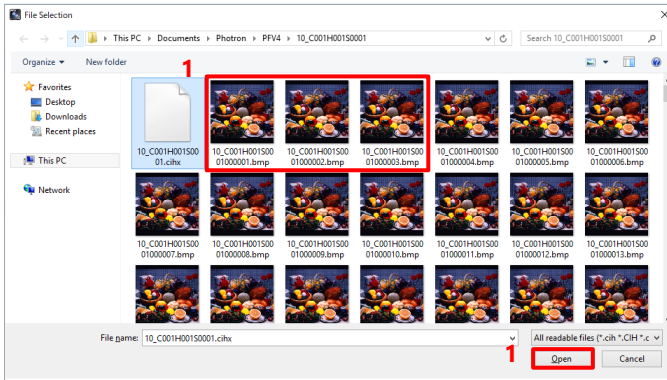

1. Click and select the desired multiple files while holding down the “Shift” key or the “Ctrl” key, and then click the [Open] button.

The data of the selected files are displayed.

### NOTE

If you select and open multiple files of BMP, TIFF, JPEG, and PNG, they are displayed as sequential frames like a video in a single view window.

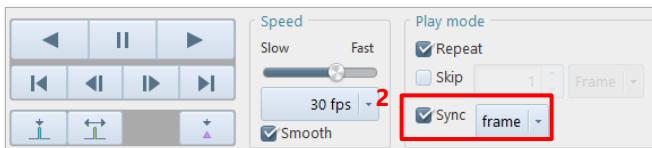

2. To play back multiple files collectively, select “Sync”.

### NOTE

- In FILE mode, user settings can be made.
- When multiple cameras are selected in MEMORY mode, the synchronized playback is always executed.

## 7.1.3. Opening Saved Data by Specifying Folder

To play back data by folder, click the [Folder] button on the [Open (folder/SD/FD/CF)] screen to be displayed after clicking the [Open (folder/SD/FD/CF)] button.

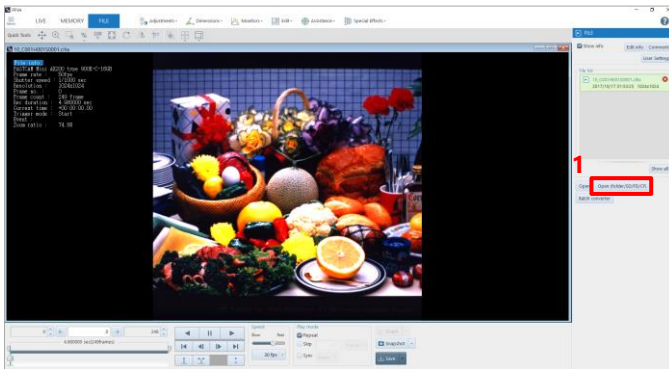

1. Click the [Open (folder/SD/FD/CF)] button.

The [Open (folder/SD/FD/CF)] screen is displayed.

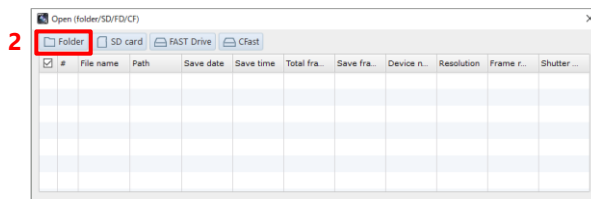

2. Click the [Folder] button.

The [Select folder] screen is displayed.

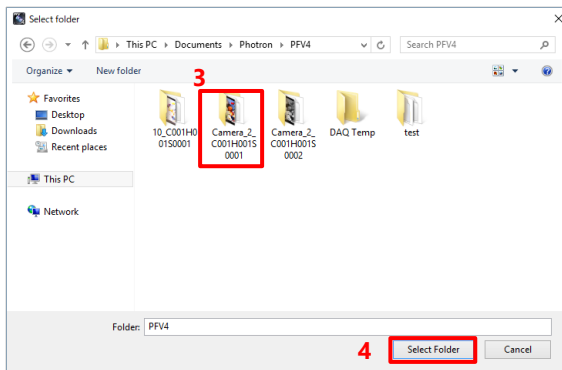

3. Select a folder.

4. Click the [Select Folder] button.

The [Open (folder/SD/FD/CF)] screen is displayed again with [Data list] updated.

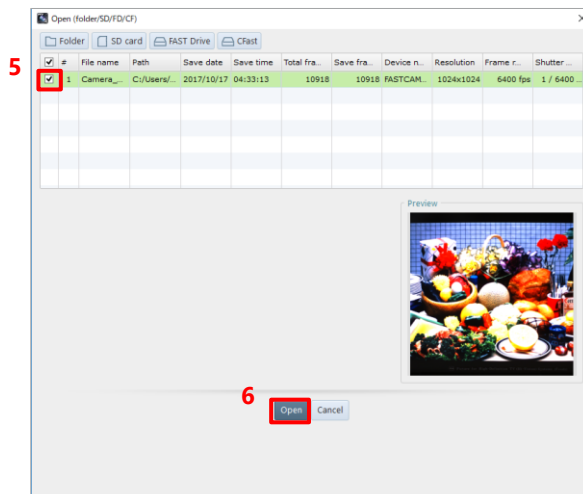

5. Check the file to open.

6. Click the [Open] button.

## 7.1.4. Sequentially Playing Back Saved Files Split Up

When a file is saved in Multi-page TIFF format or if frames are split up and saved in MRAW format, the saved files split up can be played back sequentially.

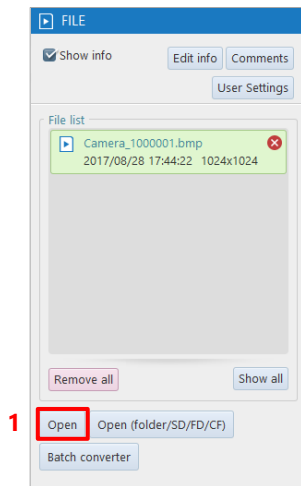

1. Click the [Open] button on the function panel in FILE mode.

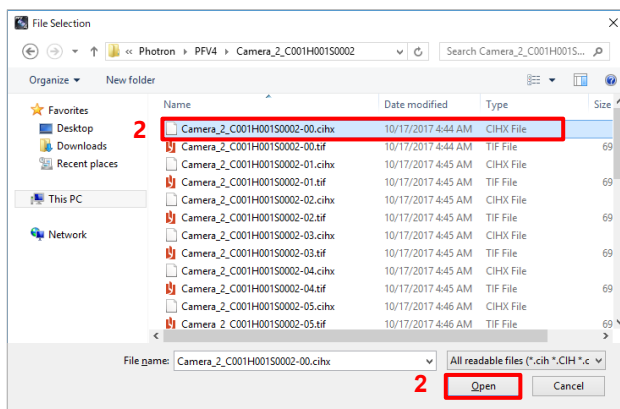

2. Select one of the saved files split up and click the [Open] button.

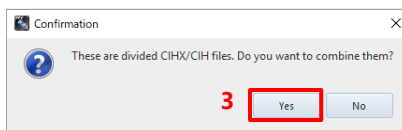

3. A message is displayed. To make a sequential playback, click the [Yes] button.

## 7.1.5. Grouping Files

You can group multiple files. Grouping files makes it possible to operate multiple files in a group unit as follows.

- Close multiple files in a group at the same time.
- Display and play together waveform data associated with a single image in a group with other images which have no waveform data.
- Name the group.

### ■ Adding files to a group

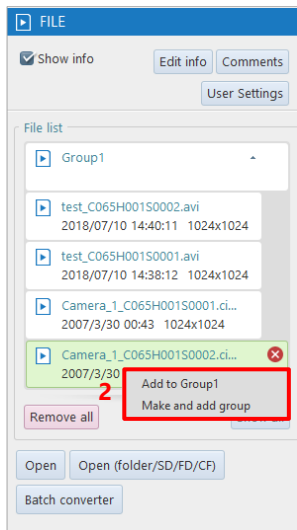

1. From the file list of the function panel, select files that are not grouped while pressing the “Ctrl” key, or by dragging.
2. Right-click the selected files and click [Make and add group] or [Add to GroupX] (adding the files to an existing group).

### ■ Changing a group name

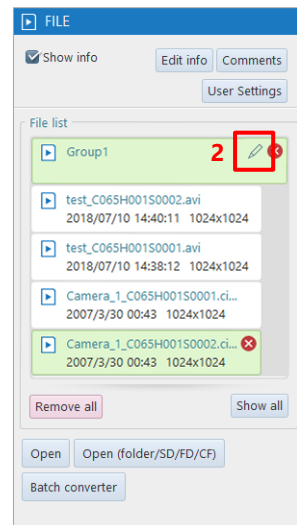

1. Select the group to change.
2. Click the edit button.

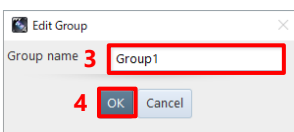

3. Enter the group name.
4. Click the [OK] button.



## ■ Ungrouping files

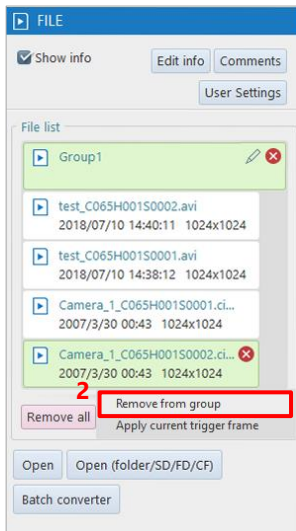

1. Select files while pressing the [Ctrl] key, or by dragging.
2. Right-click the selected files and click [Remove from group].

## ■ Deleting files

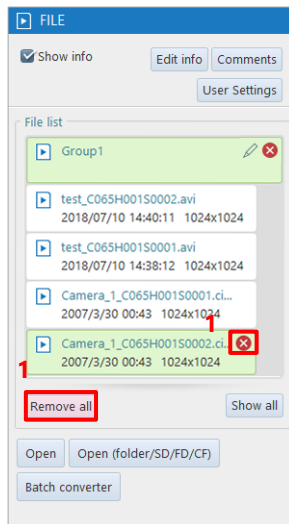

1. Click the symbol to remove appears at the upper right corner of the selected file or click the [Remove all] button.

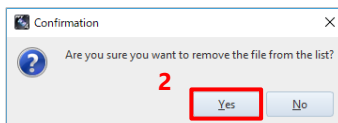

2. After the confirmation dialog appeared, click the [Yes] button.

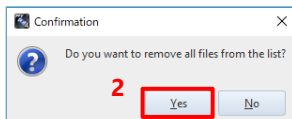

## 7.1.6. Re-saving Loaded File

You can load the data saved in a file and re-save it in another file format.

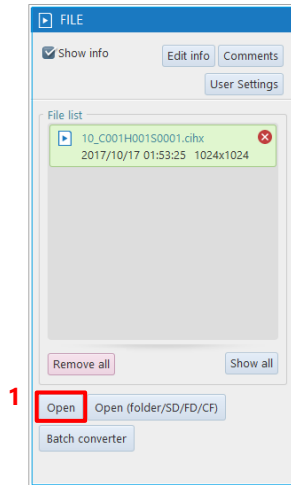

1. Click the [Open] button on the function panel in FILE mode.  
Open a desired file to be re-saved.

### REFERENCE

For how to open, see “7.1.1 Opening Saved Data” on page 151.

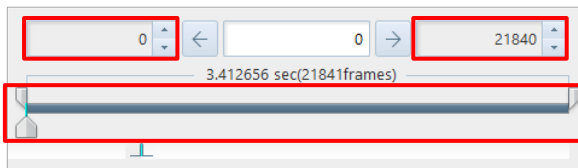

2. If, before re-save, there are any changes in the range to save or others, set them by using the recording/playback panel.

### REFERENCE

For the recording/playback panel, see “5.2 Playing Back Recorded Data” on page 100.

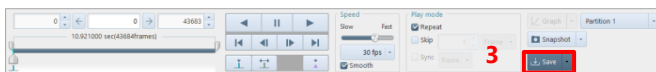

3. Click the [Save] button.  
The [Save] screen is displayed.

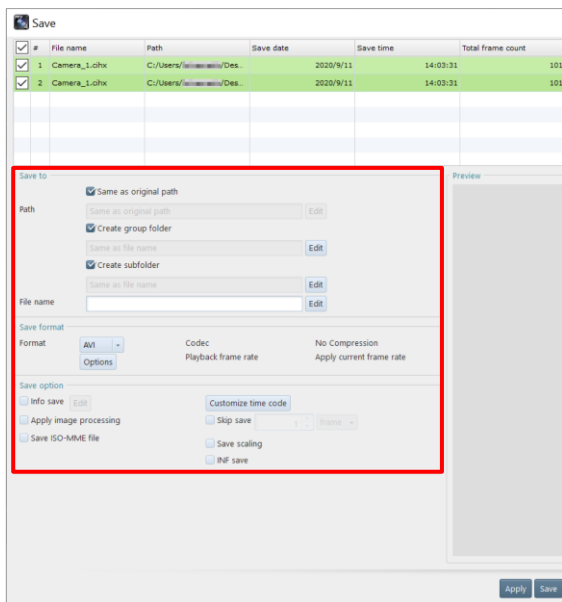

4. After specifying the destination, enter a filename, and change the settings about save as necessary.

## REFERENCE

For the recording/playback panel, see “6.2.9 File Formats and Options” on page 126.

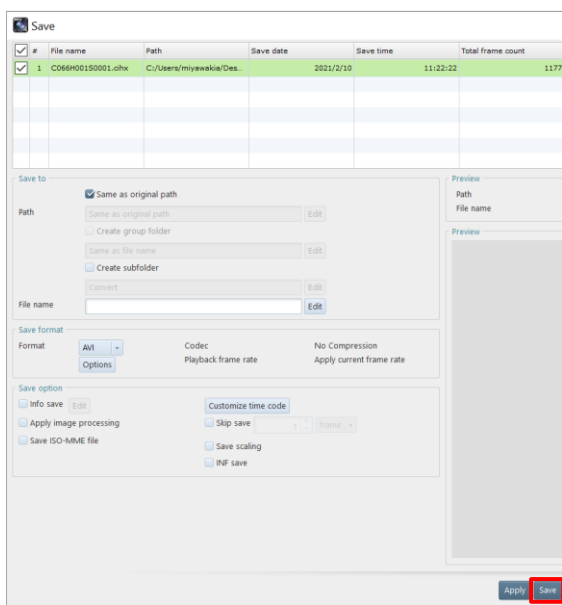

5. Click the [Save] button.  
The data is resaved (saved as a new name).

## CAUTION

When an SSD for PhotoCamSpeeder V2 is connected with the PC, do not specify this SSD as the destination where it is re-saved. If data is re-saved from PFV, reading the data from the SSD and writing data to the SSD by using Speeder V2 will not work properly.

In addition, if you specify the path containing “SPEEDER” as a drive name, a warning message appears.

## 7.2. Batch Data Conversion

This function converts and saves multiple files to a specific file format in batch. For example, you can save images in a file format that downloads quickly, such as RAW Bayer format, RAWW Bayer format, and MRAW Bayer format, during shooting, and then convert them all to AVI or another format.



### CAUTION

If you perform an operation such as formatting or renaming a data file in a FAST Drive via USB, the operation result will not be reflected to data to be acquired via a LAN cable until PFV is reconnected. Similarly, if you perform such an operation via a LAN cable, the operation result will not be reflected to data to be acquired via USB until PFV is reconnected.

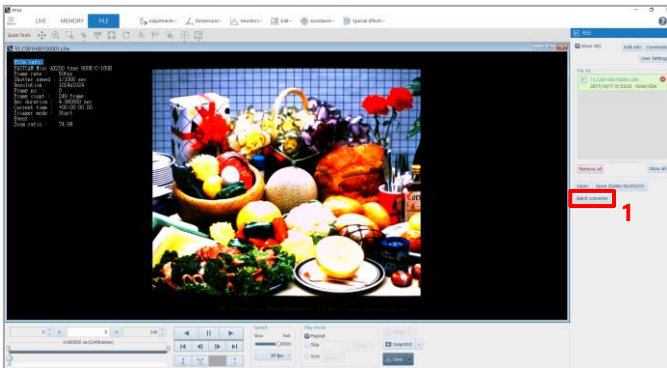

1. Click the [Batch converter] button in FILE mode.  
The [Batch converter] screen is displayed.



### REFERENCE

For details of “Batch converter” items, see “6.1 File Save Settings” on page 111.

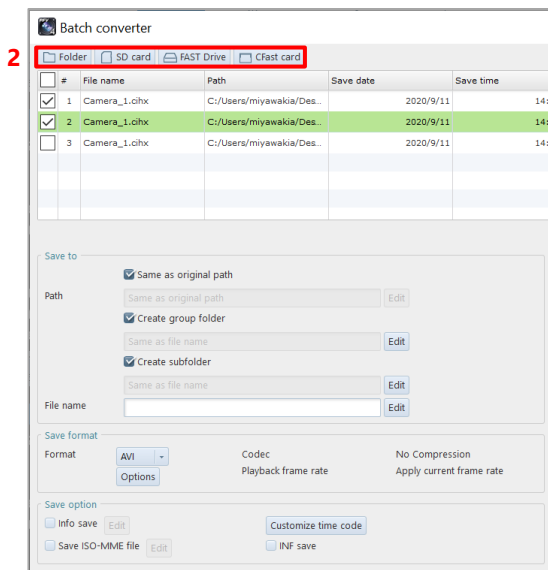

2. Click the [Folder], [SD card], [FAST Drive], or [CFast] button which is a location where the file to convert is saved.



### CAUTION

Multiple selections of [Folder], [SD card], [FAST Drive], and [CFast] are not allowed.

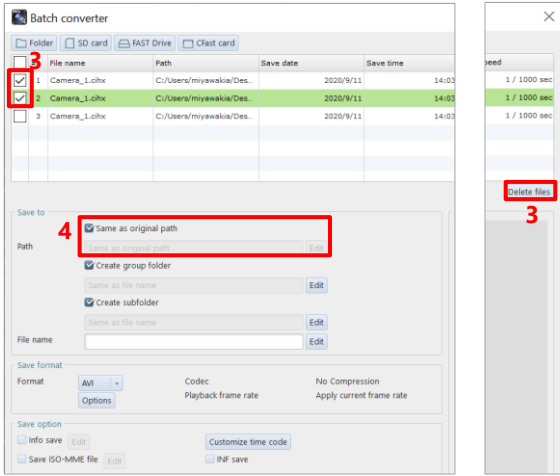

3. If the list contains any files that are not targeted for batch conversion, uncheck the files to exclude and click the [Edit] button.

To delete files from the list, select the files to delete and click the [Delete files] button.

4. To change the save path, uncheck the [Same as original path] and click the [Edit] button.

The [Select folder] screen is displayed.

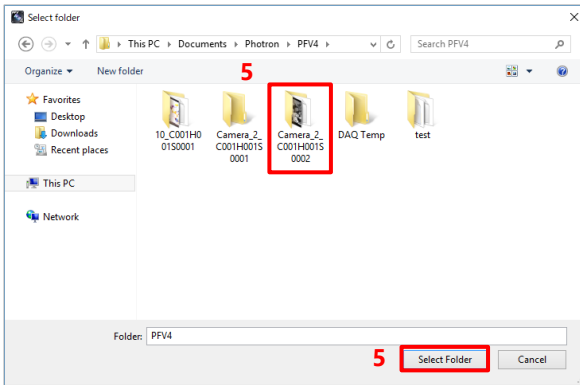

5. Select a folder where the file to convert is saved and click the [Select Folder] button.

The CIHX files in the selected folder are displayed in list form.

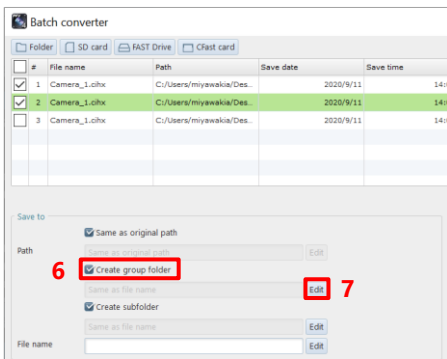

6. To create a group folder, check the “Create group folder”.

7. Click the [Edit] button to edit the group folder settings.

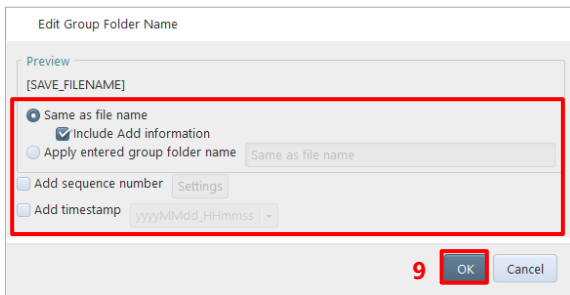

8. Configure the group folder name settings.

- To set the group folder name to be the same as the file name, check the “Same as file name”.

- To use any group folder name, check the “Apply entered group folder name” and enter a group folder name in the entry field.

9. Click the [OK] button.

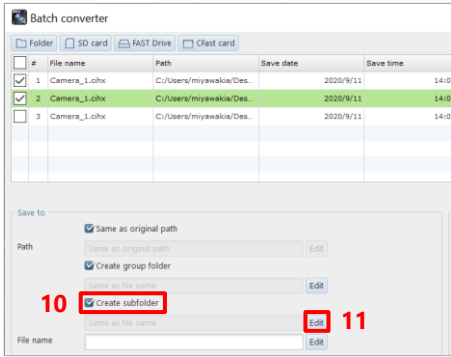

10. To create a subfolder, check the “Create subfolder”.
11. Click the [Edit] button to edit the subfolder settings.

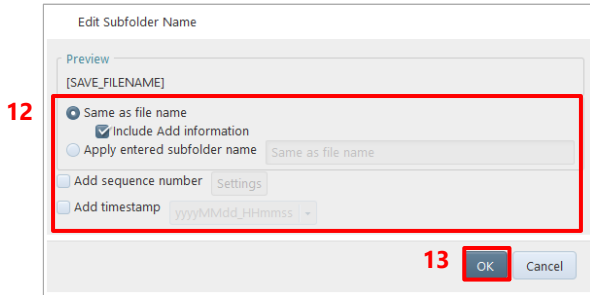

12. Configure the subfolder name settings.
  - To set the subfolder name to be the same as the file name, check the “Same as file name”.
  - To use any subfolder name, check the “Apply entered group folder name” and enter a subfolder name in the entry field.

13. Click the [OK] button.

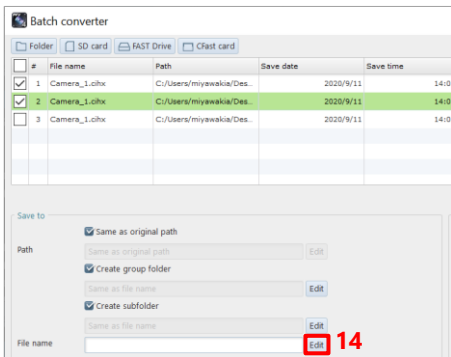

14. To change the file name, click the [Edit] button.

The [Edit File Name] screen is displayed.

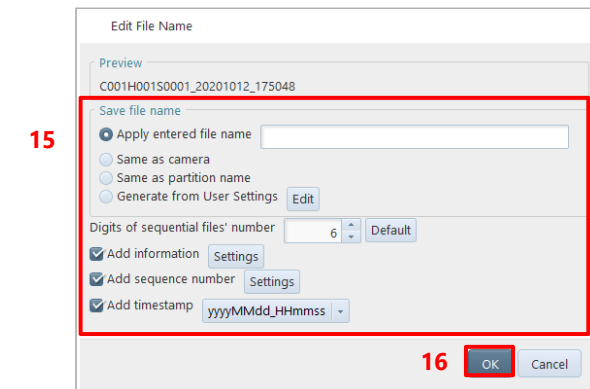

15. Specify the file name.  
The items to set are as follows.
  - Apply entered file name:  
To use the desired filename, choose this and enter the filename.
  - Same as original file name:  
To use the same name as the original filename, choose this.
16. Click the [OK] button.

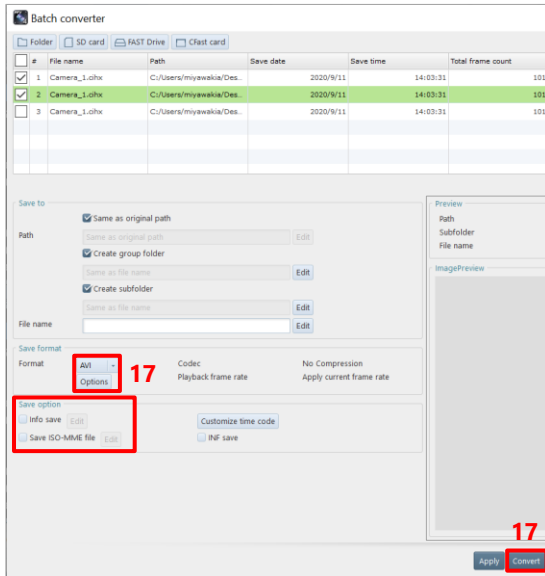

- Specify the save file format by using [▼] in the file format field and click the [Convert] button.

Depending on the format, “Save option” allows you to make detailed settings for save, such as a compression rate.

To save the file in bayer format, check “Save Bayer Format”.

To save the information added to the screen, check “Info save”.

To save the ISO-MME file, check “Save ISO-MME file”.

The [Progress] screen is displayed.

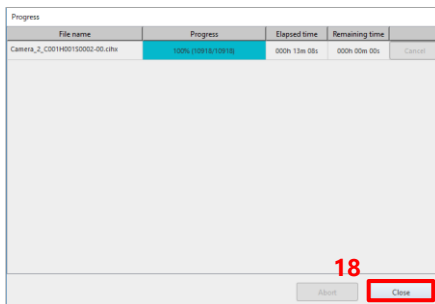

- Click the [Close] button to close the dialog box manually if you do not have “Close the progress window automatically after saving is complete” checked in [MENU] - [Configuration] - [Save].

## NOTE

You can also convert multiple files by batch after opening them. However, image area selection and image processing performed for the open files cannot be applied. If you want to apply image area selection and image processing performed for the open files and to convert them by batch, click the [Save] button on the recording/playback panel, and select and convert multiple files from the file list.

For details, see the “7.1.6 Re-saving Loaded File” on page 158.

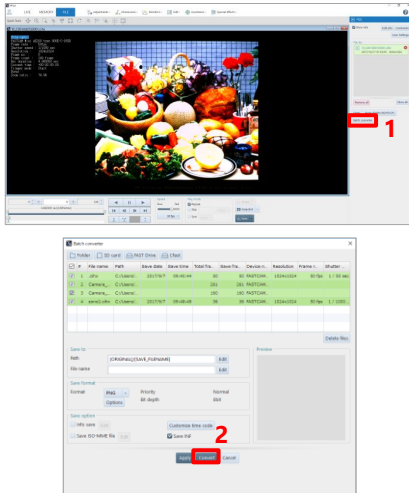

1. In FILE mode, open all the files to convert by batch.

Click the [Batch converter] button.

The [Batch converter] screen is displayed.

2. Click the [Convert] button.

## CAUTION

When you convert files by batch after opening them, the following save data will not be applied.

- Layout save
- Bayer format save (The settings on the [Batch converter] screen will be applied.)
- File format (The settings on the [Batch converter] screen will be applied.)
- File format options (The settings on the [Batch converter] screen will be applied.)

## REFERENCE

- For how to open multiple data, see “7.1.2 Opening Multiple Saved Data” on page 153.
- For how to edit files before saving them, see “Chapter 6 Saving Data” on page 110.



## 7.3. Controlling Data in an External Device

Here, playback and other methods for the data saved in an SD card, a FAST Drive, or a CFast card are described.

### 7.3.1. Loading Images from SD Card

You can play back the images saved in the SD card by a camera.



#### CAUTION

- Only the images saved by the SD card-ready camera can be played back.
- To play back the images in the SD card, load the SD card data directly with the PC where PFV is installed. Use the PC with an SD card reader or the PC connected with it for the operation.

1. Set the SD card to the SD card reader.  
A dialog asks you whether to format it.

2. Click the [Cancel] button.

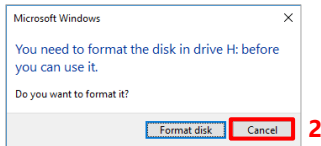

#### CAUTION

If you click the [Format disk] button, the SD card is formatted, and all the saved images are deleted.

3. Click the [Open (folder/SD/FD/CF)] button on the tool menu in FILE mode.  
The “Open (folder/SD/FD/CF)” dialog is displayed.

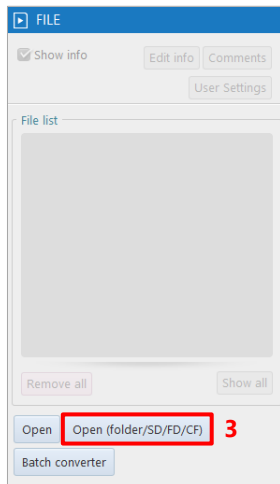

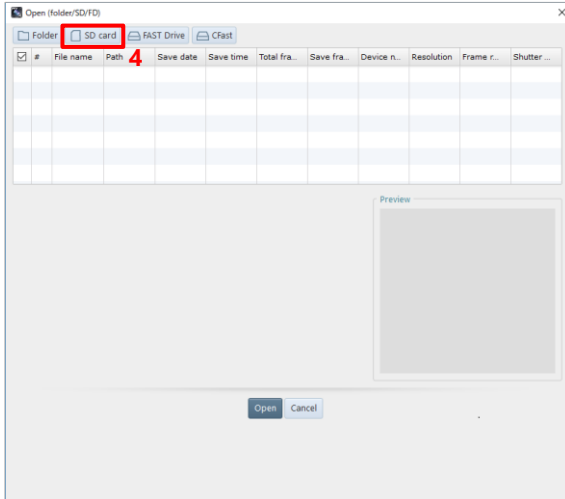

- Click the [SD card] button.  
The “SD Memory Card” dialog is displayed.

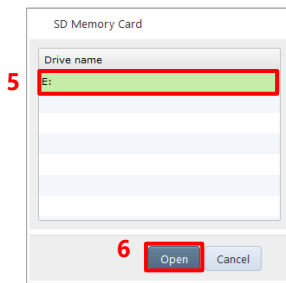

- Choose the drive of the connected SD card.
- Click the [Open] button.  
The list of the images saved in the SD card is displayed.

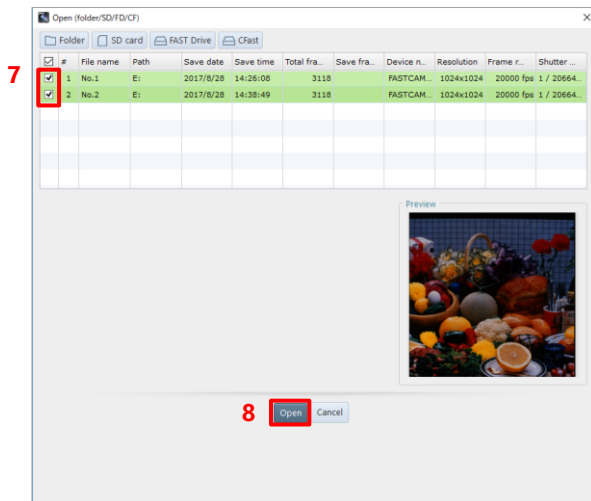

- Check the images to load (multiple images can be selected).
- Click the [Open] button.  
The selected images are displayed on the view window.

## 7.3.2. Loading Images from FAST Drive

You can play back the images saved in the FAST Drive.



### CAUTION

When using a LAN, the images from the camera selected in LIVE mode will be loaded.

1. Connect the FAST Drive to the camera or to the PC via FAST Dock.
2. Click the [Open (folder/SD/FD/CF)] button on the function panel in FILE mode.  
The “Open (folder/SD/FD/CF)” dialog is displayed.

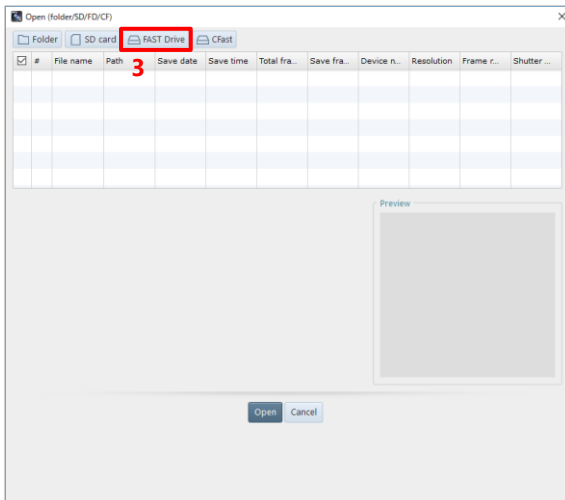
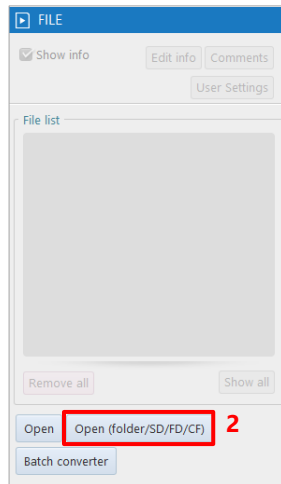

3. Click the [FAST Drive] button.  
The “FAST Drive” dialog is displayed.  
For MH6, you will be prompted for a password when selecting a drive. The initial password is “01234567”.

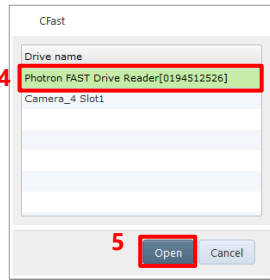

4. Select the connected FAST Drive.
5. Click the [Open] button.  
The list of the images saved in the FAST Drive is displayed.

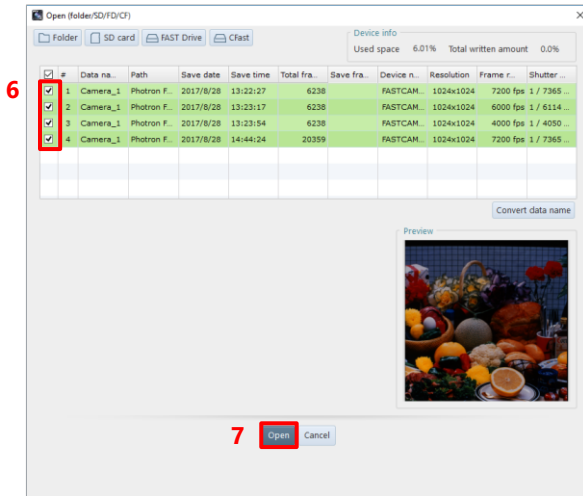

6. Check the images to load (multiple images can be selected).
7. Click the [Open] button.  
The selected images are displayed on the view window.

## NOTE

- Clicking the [Convert data name] button on the [Open (folder/SD/FD/CF)] screen displays the “Fast Drive data name conversion” dialog.

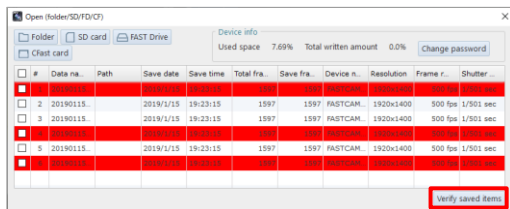

1. Enter a data name in “New data name”.  
To add a sequence number to a data name, select the “Add sequence number” check box.
2. Click the [OK] button.  
The name is converted to the entered name.

- For MH6, it is possible to change the FAST Drive password.
- In addition, the [Verify saved items] function is provided to check whether the selected files are saved by comparing data in the FAST Drive with the CIHX file in the specified folder. Click the [Verify saved items] button to use this function. The files that are not saved is highlighted in red.

### 7.3.3. Loading Images from CFast Card

You can play back the images saved in the CFast card.



#### CAUTION

- When using a LAN, the images from the camera selected in LIVE mode will be loaded.
- To directly load data from the card reader, install PFV to PC beforehand.

1. Set the CFast card to the CFast card reader.  
A dialog asks you whether to format it.
2. Click the [Cancel] button.

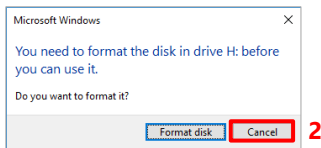

#### CAUTION

If you click the [Format disk] button, the CFast card is formatted, and all the saved images are deleted.

3. Click the [Open (folder/SD/FD/CF)] button on the function panel in FILE mode.  
The “Open (folder/SD/FD/CF)” dialog is displayed.

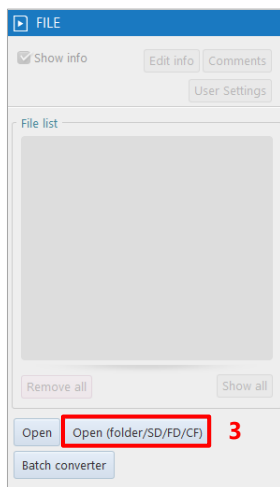

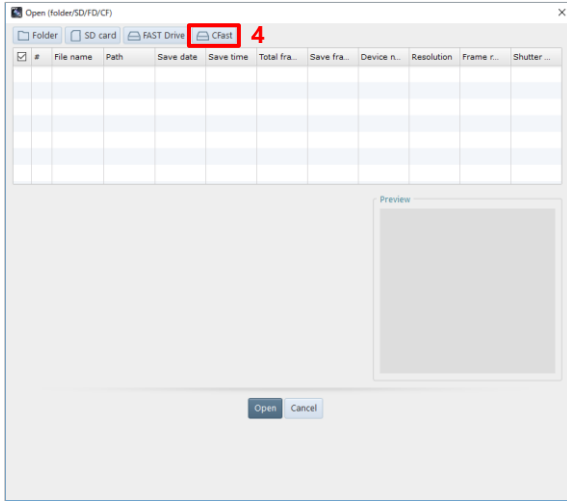

- Click the [CFast] button.  
The “CFast” dialog is displayed.

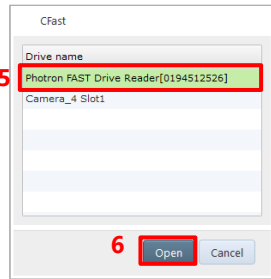

- Select the connected CFast.
- Click the [Open] button.  
The list of the images saved in the CFast is displayed.

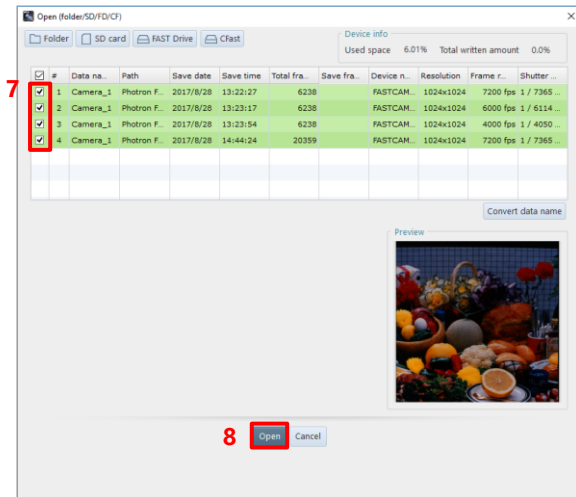

- Check the images to load (multiple images can be selected).
- Click the [Open] button.  
The selected images are displayed on the view window.

# 8

## Chapter 8 How to Use Tool Menu

This chapter describes how to use the tool menu and function panels. The tool menu and the function panel can be used in combination with the quick toolbar.

# 8.1. Image Quality Adjustment Tools

By clicking [Adjustments] on the tool menu, you can call the following tools for image quality adjustment. For details of each tool, see the corresponding reference.

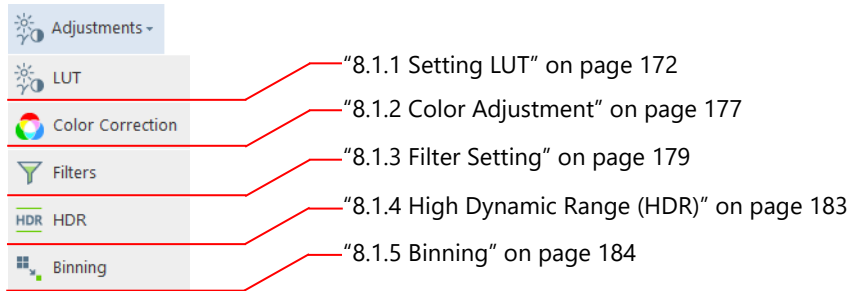

## 8.1.1. Setting LUT

By setting a LUT (Look Up Table), you can adjust the image brightness etc. Moreover, you can also specify the range to apply the LUT settings, on the image.

### NOTE

When this function is selected, the information set on the camera is loaded and displayed on the tool panel.

**Original image**



**After image quality adjustment**



### CAUTION

While this function is running, the following functions will be disabled.

- Stabilization
- Lens distortion correction
- Keystone correction



The description of the [LUT] tab is as follows.

**For [LUT] tab**

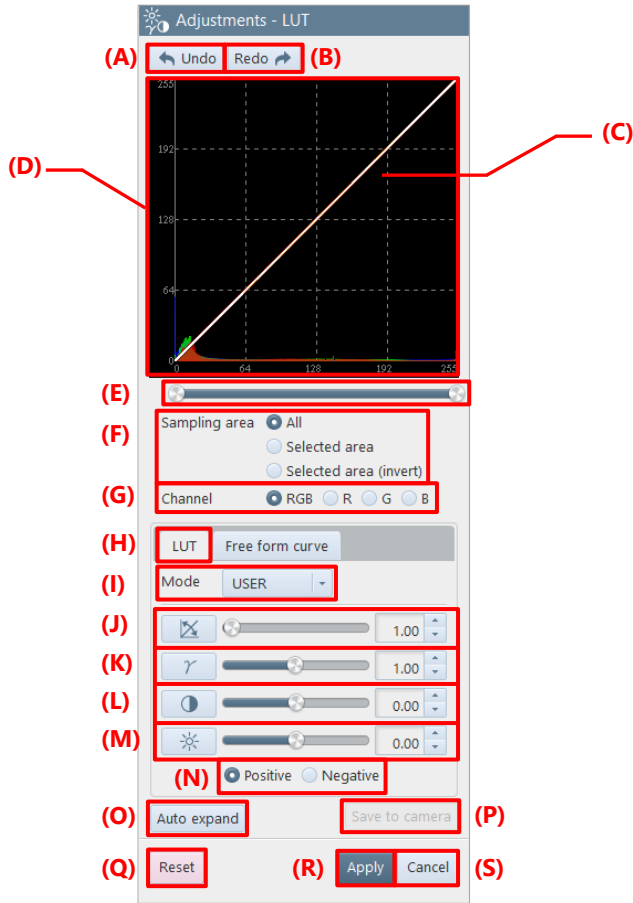

Item	Name	Function
(A)	Undo	Undoes the previous action.
(B)	Redo	Redoes the undone action.
(C)	LUT graph	This is a LUT parameter graph. Its X-axis is the input brightness, and the Y-axis is the output brightness. The LUT of RGB channels is drawn in each color. For monochrome, it is drawn in the form of a white curve. The maximum values of both the axes are those which can be expressed by the bit depth of the device (example: 4,096 for 12 bits), and an auxiliary grid of 4x4 is drawn to the depth.
(D)	Histogram/Graph display region	Displays the image brightness distribution (histogram) based on the settings. The brightness distribution of RGB channels is drawn in each color. For monochrome images, the monochrome histogram is drawn in red. The maximum value of the horizontal axis of the histogram is that which can be expressed by the bit depth of the device, and the maximum value of the vertical axis is a value at the top.
(E)	I/O range bar	Slide the knobs at both the ends of the bar to set the I/O range. The graph changes automatically based on the settings.

Item	Name	Function
(F)	Sampling area	Choose “All”, “Selected area”, or “Selected area (invert)”, which is the area of the image that reflects the image quality adjusted by the LUT. <ul style="list-style-type: none"> <li>• All: Reflects in the whole image.</li> <li>• Selected area: Reflects only in the area inside the box drawn on the screen.</li> <li>• Selected area (invert): Reflects only in the area outside the box drawn on the screen.</li> </ul>
(G)	Channel	Choose “RGB”, “R”, “G”, or “B”, which is a channel (curve) to edit. The selected channel is displayed and then can be changed. For the color camera, three channels of RGB are displayed.
(H)	LUT	Clicking this allows you to set LUT parameters.
(I)	Mode	“USER” or “DEF1” to “DEFX” can be set from the list to be displayed by clicking. When “USER” is selected, the user can set the values (J) to (M). For “DEF1” to “DEFX”, the values set for each camera will be used.
(J)	Gain	Allows you to adjust the gain by using the slider or entering the value.
(K)	Gamma	Allows you to adjust the gamma by using the slider or entering the value.
(L)	Contrast	Allows you to adjust the contrast by using the slider or entering the value.
(M)	Brightness	Allows you to adjust the brightness by using the slider or entering the value.
(N)	Positive/Negative	Switches the LUT setting values between Positive and Negative. When Negative is selected, image quality is adjusted with the LookUpTable calculated from LUT parameters inverted.
(O)	Auto expand	Clicking this automatically calculates the areas corresponding to 2% of the minimum brightness and 2% of the maximum brightness from the image brightness distribution, and then sets the linear LUT with each of them taken as the minimum/maximum value.
(P)	Save to camera	Clicking this saves the settings to the camera.
(Q)	Reset	Returns the settings to default.
(R)	Apply	Applies the settings and closes this screen. The icon of this function is added to the effect status bar.
(S)	Cancel	Closes the screen without applying the changed settings.



## NOTE

To the color temperature and the color enhancement correction, the values set here are always applied irrespective of the ON/OFF state of the icon on the effect status bar.

For [Free form curve] tab

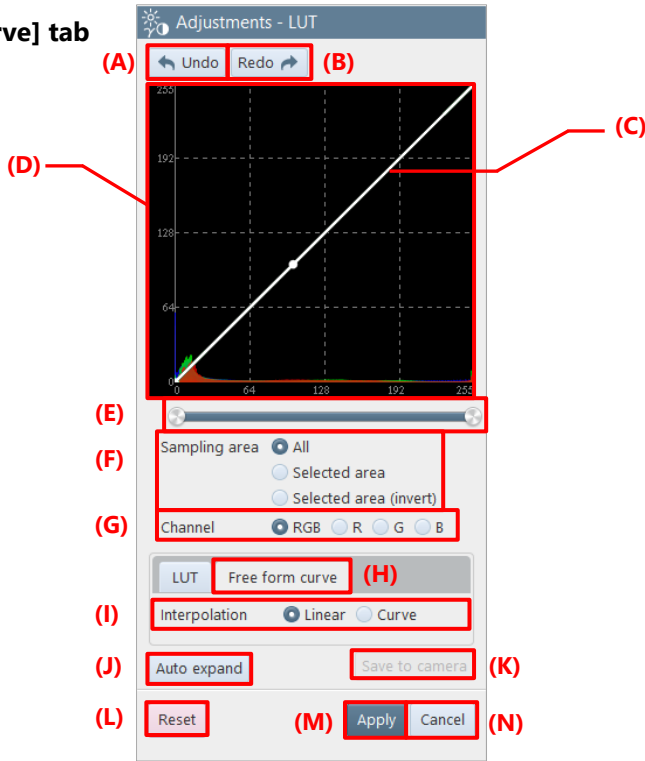

Item	Name	Function
(A)	Undo	Undoes the previous action.
(B)	Redo	Redoes the undone action.
(C)	Free curve graph	Specify the LUT setting values by using your mouse to adjust the curve. Its X-axis is the input brightness, and the Y-axis is the output brightness. The LUT of RGB channels is drawn in each color. For monochrome, it is drawn in the form of a white curve. The maximum values of both axes are those which can be expressed by the bit depth of the device (example: 4,096 for 12 bits), and an auxiliary grid of 4 x 4 is drawn to the depth. The number of inflection points that can be added in drawing a free curve is a maximum of 256 irrespective of the bit depth.
(D)	Histogram/Graph display region	Displays the image brightness distribution (histogram) based on the settings. The brightness distribution of RGB channels is drawn in each color. For monochrome images, the monochrome histogram is drawn in red. The maximum value of the horizontal axis of the histogram is that which can be expressed by the bit depth of the device, and the maximum value of the vertical axis is a value at the top.
(E)	I/O range bar	Slide the knobs at both the ends of the bar to set the I/O range. The graph changes automatically based on the settings.

Item	Name	Function
(F)	Sampling area	Choose “All”, “Selected area”, or “Selected area (invert)”, which is the area of the image that reflects the image quality adjusted by the LUT. <ul style="list-style-type: none"> <li>• All: Reflects in the whole image.</li> <li>• Selected area: Reflects only in the area inside the box drawn on the screen.</li> <li>• Selected area (invert): Reflects only in the area outside the box drawn on the screen.</li> </ul>
(G)	Channel	Choose “RGB”, “R”, “G”, or “B”, which is a channel (curve) to edit. The selected channel is displayed and then can be changed. For the color camera, three channels of RGB are displayed.
(H)	Free form curve	Clicking this allows you to set a free curve graph.
(I)	Interpolation	Choose “Linear” or “Curve”, which is a method to perform interpolations between the points when the free curve graph is changed.
(J)	Auto expand	Clicking this automatically calculates the areas corresponding to 2 % of the minimum brightness and 2 % of the maximum brightness from the image brightness distribution, and then sets the linear LUT with each of them taken as the minimum/maximum value.
(K)	Save to camera	Clicking this saves the settings to the camera.
(L)	Reset	Returns the settings to default.
(M)	Apply	Applies the settings and closes this screen. The icon of this function is added to the effect status bar.
(N)	Cancel	Closes the screen without applying the changed settings.

## 8.1.2. Color Adjustment

The color adjustment feature allows you to set the following three items.

- Color temperature
- Color saturation
- Color enhancement correction



### CAUTION

- This function is not available to monochrome cameras or monochrome files.
- In file mode, color temperature and color enhancement correction can be set for images saved in MRAW or RAWW bayer format, or in GRAW format.



### NOTE

- The set information is saved for each selected device and registered on the effect status bar.
- To the color temperature and the color enhancement correction, the values set here are always applied irrespective of the ON/OFF state of the icon on the effect status bar.

**Original image**



**After adjustment**



The description of the [Adjustments - Color Correction] screen is as follows.

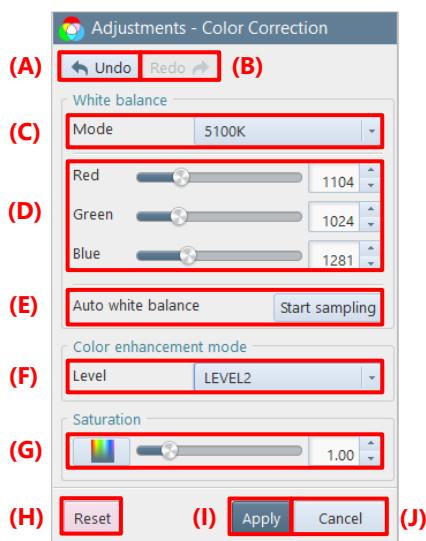

Item	Name	Function
(A)	Undo	Undoes the previous action.
(B)	Redo	Redoes the undone action.
(C)	Mode	Choose 3100K, 5100K, or USER, which is a color temperature to use, from the list to be displayed by clicking.
(D)	Red/Green/Blue	Set each color temperature correction value for Red/Green/Blue by using the slider bar knob or entering a value.
(E)	Auto white balance	Clicking this adjusts the white balance automatically.
(F)	Color enhancement mode	Select a level from the list to be displayed by clicking the strength of color enhancement correction. There are five strength levels: OFF and LEVEL1 to LEVEL4.
(G)	Saturation	Clicking this enables an overlay. Change the color saturation setting value by using the slider bar knob or entering a value. This function is available even to the images that are not saved in bayer format.
(H)	Reset	Returns the settings to default.
(I)	Apply	Applies the settings and closes this screen. The icon of this function is added to the effect status bar.
(J)	Cancel	Closes the screen without applying the changed settings.

**NOTE**

When closing the dialog without using a command of [Apply] or [Cancel], you will be asked whether to save the changes.

### 8.1.3. Filter Setting

On this screen, you can apply the following filters to images.

#### ■ Median filter

This filter has the effect of removing salt-and-pepper noise etc. On PFV, the median filter of 3 x 3 is applied.

**Original image**



**Median filter**



#### ■ Gaussian filter

This filter has the effect of smoothing an edge.

For 3 x 3 or 5 x 5, the Gaussian filter for that kernel size is applied. The filter for 5 x 5 is more effective than that for 3 x 3.

**Original image**



**3 x 3**



**5 x 5**

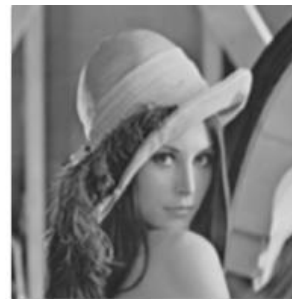

#### ■ Edge enhancement (unsharp masking)

This filter has the effect of enhancing an edge. As the LEVEL grows higher, enhancing the edge becomes more effective.

**Original image**



**LEVEL1**



**LEVEL2**



**LEVEL3**



■ **Sobel filter**

This filter differentiates the image to emphasize the edges of particles and dust.



■ **Spot noise reducer**

This is a filter for removing the specified pixel size of noise.

For example, when you choose “Diameter 5” in radius, the noise of 1 to 5 pixels will be removed.



■ **Interpolation of sub-pixels when an image is zoomed in/out**

This filter has the effect of interpolating the brightness values of sub-pixels when an image is zoomed in. “LINEAR” performs interpolations more smoothly than “NEAREST”.

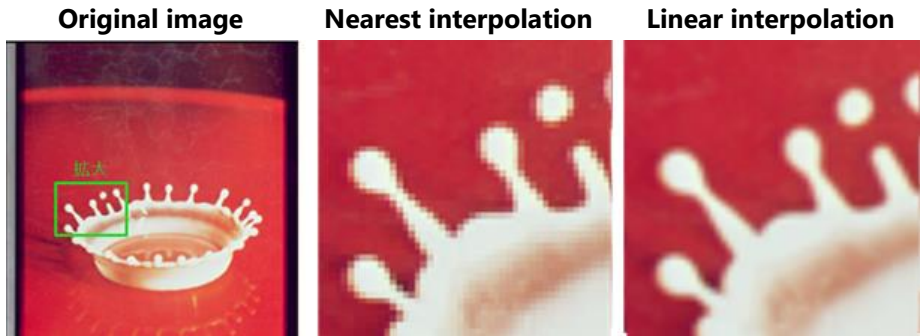



The description of the [Adjustments - Filters] screen is as follows.

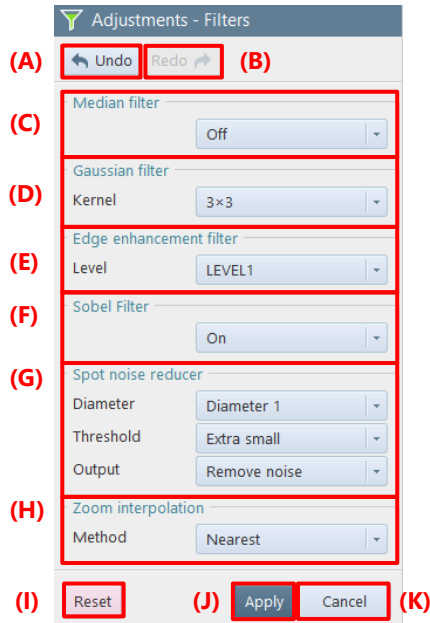

Item	Name	Function
(A)	Undo	Undoes the previous action.
(B)	Redo	Redoes the undone action.
(C)	Median filter	To set the Median filter, choose “On”.
(D)	Gaussian filter	To set the Gaussian filter, select an item to use from the list to be displayed by clicking. The list items are as follows. <ul style="list-style-type: none"> <li>• Off</li> <li>• 3 x 3</li> <li>• 5 x 5</li> </ul>
(E)	Edge enhancement filter	To set the edge enhancement filter, select an item to use from the list to be displayed by clicking. The list items are as follows. <ul style="list-style-type: none"> <li>• Off</li> <li>• LEVEL1</li> <li>• LEVEL2</li> <li>• LEVEL3</li> </ul>

Item	Name	Function
(F)	Sobel filter	To set the Sobel filter, choose “On”.
(G)	Spot noise reducer	<p>To set the spot noise reducer, select an item to use from the list to be displayed by clicking “Diameter”, “Threshold”, or “Output”.</p> <ul style="list-style-type: none"> <li>• “Diameter” You can make 11 settings: “Off” and “Diameter 1” to “Diameter 10”. “Off” will not apply the filter. “Diameter 1” to “Diameter 10” will apply the filter to remove noise having a diameter equal to or smaller than the set value. When you choose “Diameter 5”, the noise of 1 to 5 pixels will be removed.</li> <li>• “Threshold” Noise is detected according to one of the five threshold values: “Extra small”, “Small”, “Medium”, “Large”, and “Extra large”. As the selected threshold value becomes smaller, noise is detected more easily, and vice versa.</li> <li>• “Output” You can choose show noise or remove noise. For show noise, the pixels judged as noise are highlighted in green. For remove noise, they are corrected and displayed.</li> </ul>
(H)	Zoom interpolation	To set the zoom interpolation, select an item to use from the list to be displayed by clicking. You can choose “Nearest” or “Linear”.
(I)	Reset	Returns the settings to default.
(J)	Apply	Applies the settings and closes this screen. The icon of this function is added to the effect status bar.
(K)	Cancel	Closes the screen without applying the changed settings.

## 8.1.4. High Dynamic Range (HDR)

In such a case where a dark subject and a bright subject coexist, by enhancing the dark section on the image and reducing the contrast of the bright section, both of them can be viewed better at the same time.

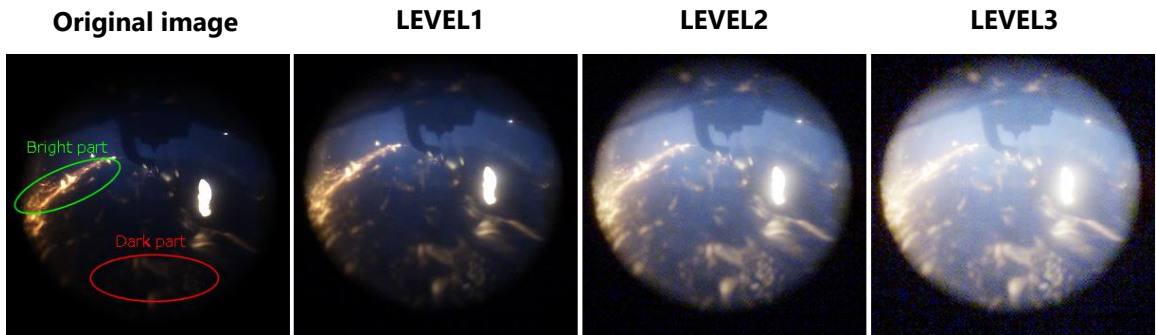

The description of the [Adjustments - HDR] screen is as follows.

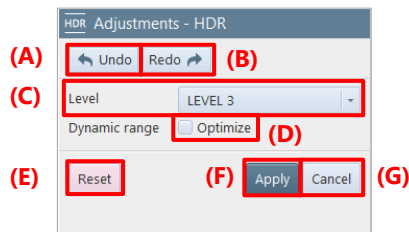

Item	Name	Function
(A)	Undo	Undoes the previous action.
(B)	Redo	Redoes the undone action.
(C)	Level	Select the average brightness of tone mapping to use from the list to be displayed by clicking. As the level becomes larger and smaller, higher and lower average brightness values are mapped respectively.
(D)	Optimize	Checking this will result in more extended brightness if the dynamic range is not reached yet. It will be brighter visually; however, if there are any overexposure pixels due to noise etc., the effect will not be achieved.
(E)	Reset	Returns the settings to default.
(F)	Apply	Applies the settings and closes this screen. The icon of this function is added to the effect status bar.
(G)	Cancel	Closes the screen without applying the changed settings.

## 8.1.5. Binning

Brightness can be increased by combining pixel values, which reduces the image resolution. For example, binning 2 x 2 pixels will make each of the vertical and horizontal resolutions 1/2 but double the brightness.

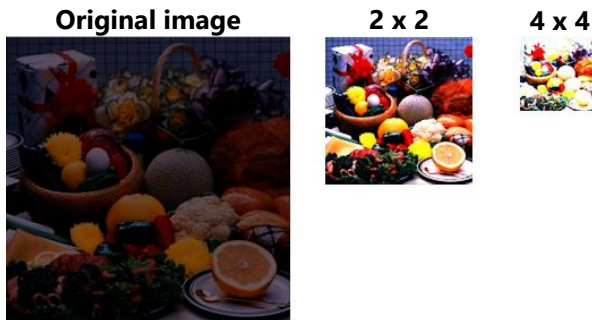

The description of the [Adjustments - Binning] screen is as follows.



Item	Name	Function
(A)	Undo	Undoes the previous action.
(B)	Redo	Redoes the undone action.
(C)	Size	Choose “2 x 2” or “4 x 4”, which is the number of surrounding pixels to be accumulated by binning. For “2 x 2”, vertical and horizontal pixels are accumulated 2 pixels at a time, achieving the brightness of 1 pixel. Therefore, the resolution is made half in both directions. For “4 x 4”, they are accumulated 4 pixels at a time; therefore, the resolution is made 1/4 in both directions.
(D)	Reset	Returns the settings to default.
(E)	Apply	Applies the settings and closes this screen. The icon of this function is added to the effect status bar.
(F)	Cancel	Closes the screen without applying the changed settings.



### CAUTION

The setting is not available if the target image resolution cannot be divided by 2 or 4. If, with the multi-lock function activated, there are some cameras or files that cannot be divided by 2 or 4, the setting is not applied to such cameras or files but applied to those which can be divided.



### NOTE

- If you save the file in non-bayer format MRAW, RAWW, or GRAW, the image is saved with binning applied. Even if you open the saved file, you cannot undo the binning, but if you save the file in bayer format MRAW, RAWW, or GRAW, you can undo the binning process even after saving the file.
- To restore the settings, right-click on the binning icon on the effect status bar and click “Delete” or click the icon to turn off the binning.

## 8.2. Simple Measurement Tools

By clicking [Dimensions] on the tool menu, you can measure the length and angle of the object displayed on the video display region.

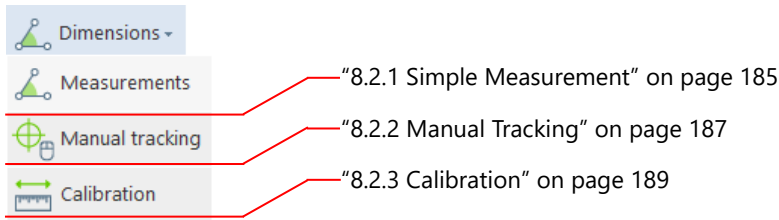

### 8.2.1. Simple Measurement

Choose the following items to measure the length and angle by clicking and dragging. The measured result is displayed on the information display area.

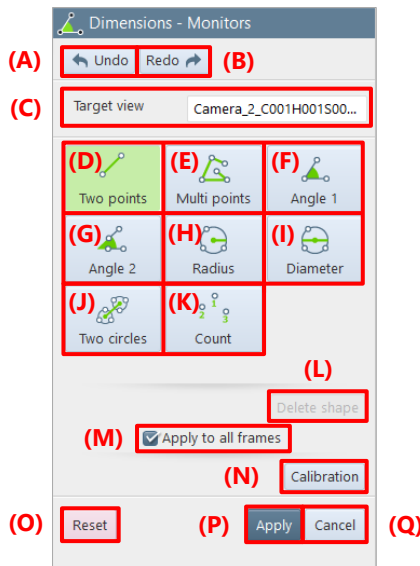

Item	Name	Function
(A)	Undo	Undoes the previous action.
(B)	Redo	Redoes the undone action.
(C)	Target view	Displays the screen on which to make a measurement.
(D)	Two points	Measures the distance between two desired points on the basis of a reference value. A reference value is 1 mm/1 pixel (default). To change it, set a scale by using scale display feature.

Item	Name	Function
(E)	Multi points	Measures the total of all the straight-line distances between multiple points (2 to 4,194,304). Connect points with straight lines in the order of clicking points, specify the last point and then right-click or press [Esc] key to finish specifying. When the points reach the maximum number (4,194,304), drawing is finished automatically and the distances between multiple points are measured.
(F)	Angle 1	Measures the angle between two lines, which consist of three points connected by clicking them on an image. The angle range can be set in the unit field of [MENU] - [Configuration] - [Preference].
(G)	Angle 2	Measures the angle between two unconnected lines, which consist of four points (two points per line). The angle range can be set in the unit field of [MENU] - [Configuration] - [Preference].
(H)	Radius	Measures the radius of the circle passing through three points, which are specified on an image.
(I)	Diameter	Measures the diameter of the circle passing through three points, which are specified on an image.
(J)	Two circles	Measures the distance between two points connecting the centers of two circles. When you specify six points on an image to draw two circles, a straight line connecting the two circle centers will be drawn and the distance between the two points will be measured.
(K)	Count	Numbers are displayed in the order as you click the screen (no measurement is made). The maximum number of points is 4,194,304 per frame.
(L)	Delete shape	Deletes all the graphics for the selected camera.
(M)	Apply to all frames	Check this to target all frames for measurement. If it is not checked, the current frame is targeted for measurement.
(N)	Calibration	Displays the [Dimensions - Calibration] screen. The simple measurement will not end.
(O)	Reset	Returns the settings to default.
(P)	Apply	Applies the settings and closes this screen. The icon of this function is added to the effect status bar.
(Q)	Cancel	Closes the screen without applying the changed settings.



## CAUTION

The graphics drawing information is not shared among modes (LIVE, MEMORY, and FILE).



## NOTE

- When there are multiple graphics, a white number is displayed for the 1st point. In LIVE mode, the maximum number of graphics drawn is 100. In MEMORY or FILE mode, it is 100 per frame.
- Drawn graphics can be enlarged to the scaling factor of the screen. However, the size of characters, lines, and points is not changed irrespective of that factor.
- Drawn graphics can be rotated to the rotation of the screen. However, graphics numbers do not rotate.
- While this function is activated, the image portion that follows the cursor will be enlarged.

## 8.2.2. Manual Tracking

Movements of the points (tracking points) displayed on the video can be digitized by clicking and registering the points of each frame.

In addition, the digitized movements can be displayed in a graph and output in a CSV file.

For details about the operation, see “Displaying the imported waveform data” on page 247 and “[Waveform Data Export] screen” on page 254.



Item	Name	Function
(A)	Undo	Undoes the previous action.
(B)	Redo	Redoes the undone action.
(C)	Target window	Displays the screen on which the target window is measured.
(D)	Move to the next frame by clicking	Selecting this check box enables to move to the next frame every time you click the image. If skip playback is enabled, the frame following the specified number of skipped frames is displayed.
(E)	Tracking point list	Displays the point number, time, coordinate value, and color of the clicked point. <ul style="list-style-type: none"> <li>[Delete]: Deletes the selected tracking point.</li> <li>[Color change]: Changes the color of the selected tracking point.</li> </ul> [Delete] and [Color change] can also be selected on the window displayed by placing the mouse cursor on a tracking point of a window.
(F)	Display coordinate values on a screen	Selecting this check box displays coordinate values on a screen.

Item	Name	Function
(G)	Apply to all frames	Selecting this check box displays tracking points on all frames. If this check box is not selected, only tracking points on the current frame are displayed.
(H)	Calibration	Displays the [Dimensions - Calibration] screen. By calibrating the measurement results in advance, the values are applied to the coordinate values.
(I)	Reset	Returns the settings to default.
(J)	Apply	Applies the settings and closes this screen. The icon of this function is added to the effect status bar.
(K)	Cancel	Closes the screen without applying the changed settings.



## NOTE

- Up to 10,000 tracking points can be added.
- Up to 10 tracking points can be added per frame.
- On a frame, it is not possible to set the same color to multiple tracking points.
- A tracking point can be moved by dragging on a screen.



## 8.2.3. Calibration

This screen allows you to set a calibration value for the simple measurement result. Moreover, you can also make the settings of ruler and grid displays.

The calibration value is a unit used when 1 pixel is replaced with the size in the real world. When you set 1 pixel at 10 cm, the calibration value will be 10 cm.

The description of the [Dimensions - Calibration] screen is as follows.

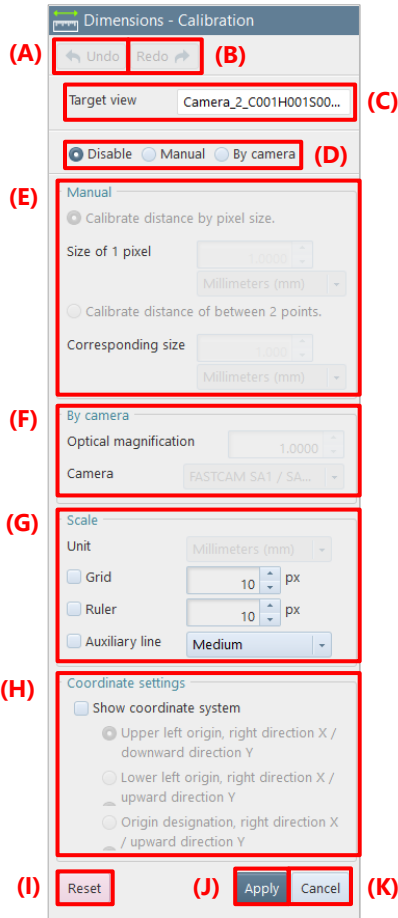

Item	Name	Function
(A)	Undo	Undoes the previous action.
(B)	Redo	Redoes the undone action.
(C)	Target view	Displays the name of the screen on which to make a measurement.
(D)	Choose scale setting method	Choose the measurement method from the following by clicking. <ul style="list-style-type: none"> <li>• Disable: Specifies no unit.</li> <li>• Manual: Sets it manually.</li> <li>• By camera: Sets it with a lens magnification and a camera model.</li> </ul>

Item	Name	Function
(E)	Manual	<p>This can be set when “Manual” is selected in (D).            Select “Calibrate distance by pixel size” or “Calibrate distance of between 2 points”.</p> <ul style="list-style-type: none"> <li>• Calibrate distance by pixel size                Size of 1 pixel: Set the size of a pixel and then select a unit by clicking [▼] under this box.</li> <li>• Calibrate distance of between 2 points                A red line is displayed on the image. Click and drag either end point of the line to lay it over a known scale in the image.                Corresponding size: Set the size of the length specified by the line and then select a unit by clicking [▼] under this box.</li> </ul>
(F)	By camera	<p>This can be set when “By camera” is selected in (D).</p> <ul style="list-style-type: none"> <li>• Optical magnification: Enter the optical magnification of a lens.</li> <li>• Camera: Clicking this displays the list of supported cameras. Select a camera to use.</li> </ul>
(G)	Scale	<p>Make the settings about a basic unit.</p> <ul style="list-style-type: none"> <li>• Unit: Select a unit to be displayed on the measurement result.</li> <li>• Grid: Checking this displays a grid and a scale. You can set the displayed width of the grid, in the field to the right.</li> <li>• Ruler: Checking this displays a ruler. You can set the displayed width of the ruler, in the field to the right.</li> <li>• Auxiliary line: Checking this displays grid hold lines. You can choose “Wide” (bisectors), “Medium” (lines dividing it into five equal parts), or “Narrow” (lines dividing it into ten equal parts), which is the displayed width of the grid, by clicking the field to the right.</li> </ul>
(H)	Coordinate system settings	<p>The reference coordinate can be set and displayed on a screen.            Show coordinate system: Selecting this check box displays the selected coordinate on a screen.            Select a coordinate to be set and displayed from the following:</p> <ul style="list-style-type: none"> <li>• Upper left origin, right direction X / downward direction Y</li> <li>• Lower left origin, right direction X / upward direction Y</li> <li>• Origin designation, right direction X / upward direction Y</li> </ul>
(I)	Reset	Returns the settings to default.
(J)	Apply	<p>Applies the settings and closes this screen.            The icon of this function is added to the effect status bar.</p>
(K)	Cancel	Closes the screen without applying the changed settings.

 **NOTE**

When you click an image with a mouse while this function is activated, the image around the clicked point will be enlarged.

## 8.3. Brightness Measurement Tools

By clicking [Monitors] on the tool menu, you can measure the brightness of an image or execute other commands.

For details of each tool, see the corresponding reference.

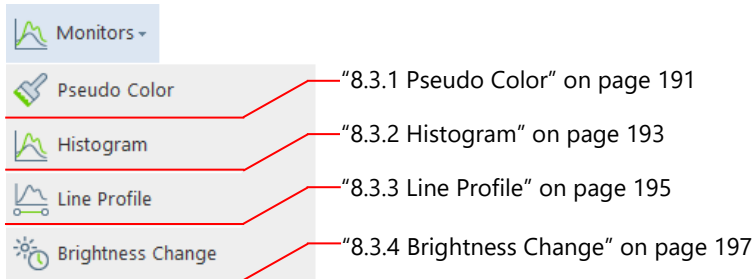

### 8.3.1. Pseudo Color

A monochrome image can be displayed in pseudo colors.  
This makes it easier to visually tell the luminance difference.

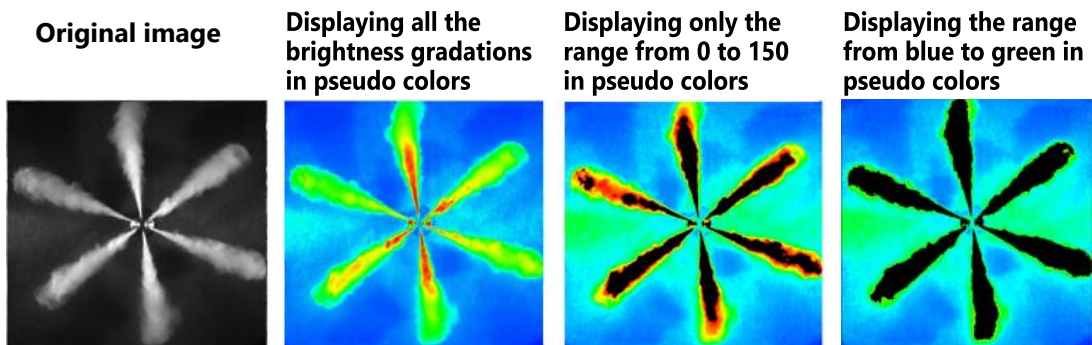

The description of the [Monitors - Pseudo Color] screen is as follows.

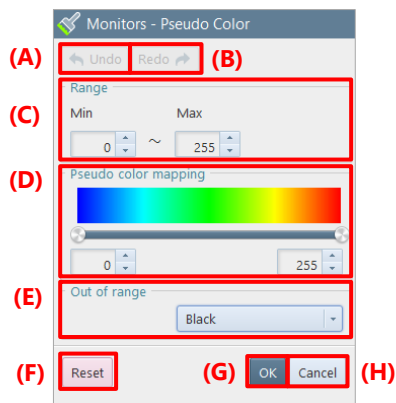

<b>Item</b>	<b>Name</b>	<b>Function</b>
(A)	Undo	Undoes the previous action.
(B)	Redo	Redoes the undone action.
(C)	Range	Set the maximum and minimum values of the gradation range to display pseudo colors.
(D)	Pseudo color mapping	Set the gradation values to color in the range set in [Range], by using the slider.
(E)	Out of range	Choose "Black" or "Original", which is the color of gradation values outside the range. The pixels having the gradation values outside the range set in "Range" are colored in black when "Black" is selected or in the color of the original image when "Original" is selected.
(F)	Reset	Returns the settings to default.
(G)	OK	Applies the settings and closes this screen.
(H)	Cancel	Closes the screen without applying the changed settings.

## 8.3.2. Histogram

When you drag the whole image or the desired range on an image, the histogram (the graph showing the distribution of brightness values) in the specified range will be displayed in the lower-left part of the video display region.

For a color image, the histogram of the averaged values of RGB is displayed.

The “Histogram” tab allows you to make a setting of the histogram to display. Moreover, the “Analyze” tab allows you to check the maximum value, minimum value, and standard deviation after conversion.

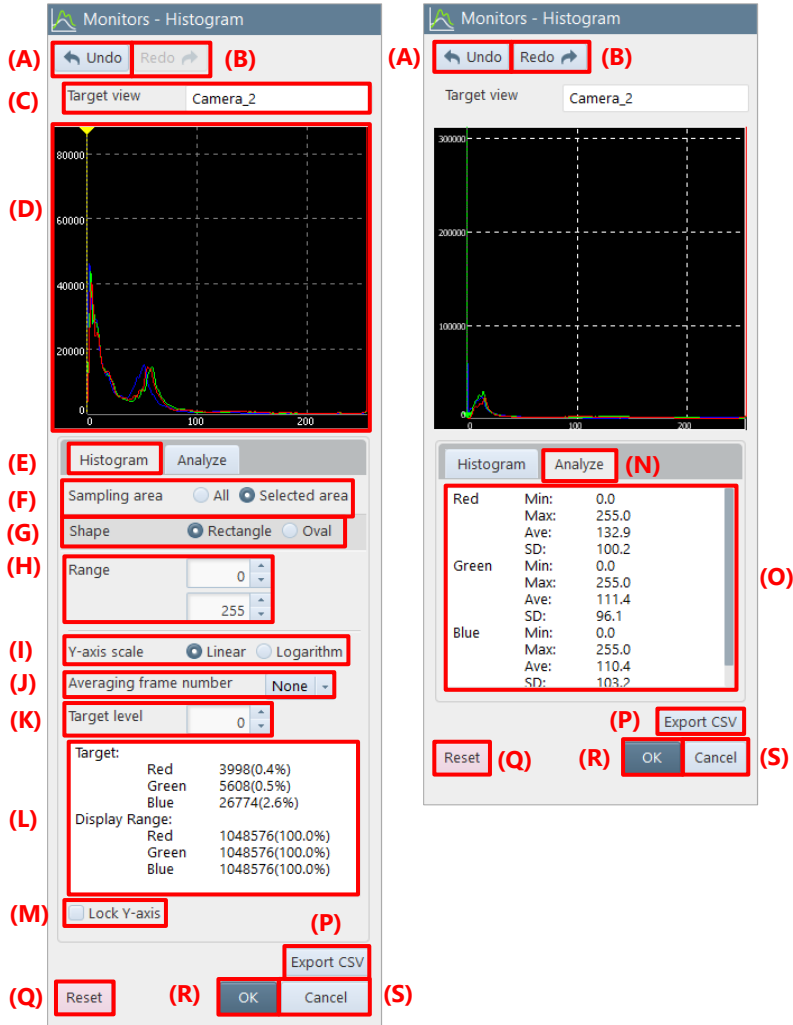

Item	Name	Function
(A)	Undo	Undoes the previous action.
(B)	Redo	Redoes the undone action.
(C)	Target view	Displays the name of the target screen for the histogram view.
(D)	Histogram	Displays the brightness of the camera in histogram form.
(E)	Histogram	Clicking this displays the setting screen for the histogram view.
(F)	Sampling area	Choose “All” or “Selected area”, which is a target for the histogram view.

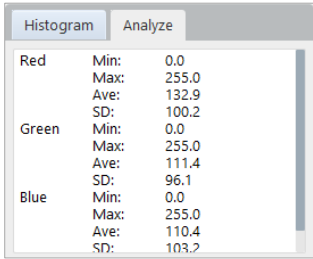
Item	Name	Function
(G)	Shape	This setting pane will be displayed when checking “Selected area” in sampling area setting. Select the shape from “Rectangle” and “Oval”. Specify the shape and position modifying / moving the sampling area over the image.
(H)	Range	Specify the range in which to display brightness. The range is set by entering its Lower and Upper values.
(I)	Y-axis scale	Choose “Linear” or “Logarithm”.
(J)	Averaging frame number	This is a function in LIVE mode. Measures the live image in time after averaging it by the specified frame count (2 to 10 frames). No averaging is performed when “None” is set.
(K)	Target level	Specify the target brightness. It can be specified within the range of “Range”.
(L)	Information display area	Displays the target level and the number of pixels in the brightness display range (that in parentheses is a proportion to the number of pixels from 0 to the upper limit) to 1st decimal place.
(M)	Lock Y-axis	Checking this will fix the vertical axis at the minimum/maximum value of brightness for the current frame.
(N)	Analyze	Clicking this displays the analysis display area.
(O)	Analysis information display area	Clicking this displays the following information selected in [Range]. 1. Minimum brightness value 2. Maximum brightness value 3. Average brightness value 4. Standard deviation  
(P)	Export CSV	Exports the brightness distribution by frame in CSV format.
(Q)	Reset	Returns the settings to default. The icon of this function is removed from the effect status bar.
(R)	OK	Applies the settings and closes this screen.
(S)	Cancel	Closes the screen without applying the changed settings.

### 8.3.3. Line Profile

When you click a start point and an end point on the screen, the brightness values of pixels on the specified line will be measured. By dragging the line to extend its width, more accurate values can be acquired.

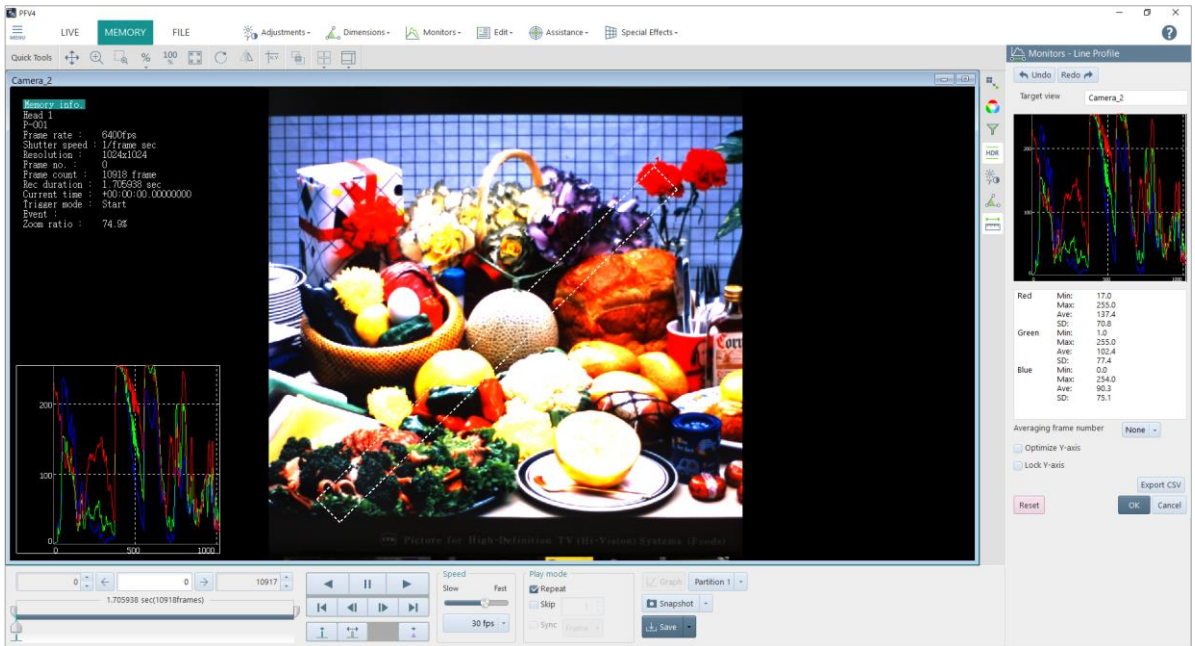

The description of the [Monitors - Line Profile] screen is as follows.

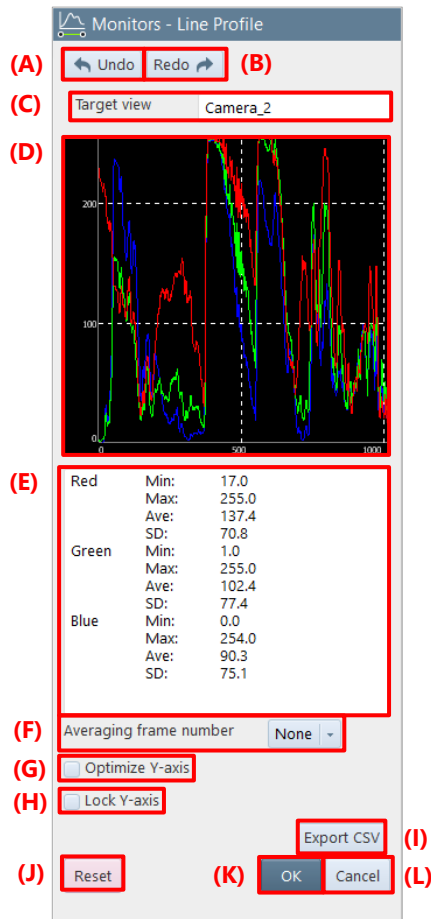

Item	Name	Function
(A)	Undo	Undoes the previous action.
(B)	Redo	Redoes the undone action.
(C)	Target view	Displays the name of the target screen for the line profile view.
(D)	Profile view	Displays the target line profile for measurement.
(E)	Information display area	Displays the following information in the range of the selected line. 1. Minimum brightness value 2. Maximum brightness value 3. Average brightness value 4. Standard deviation
(F)	Averaging frame number	Measures the live image in time after averaging it by the specified frame count (2 to 10 frames). No averaging is performed when “None” is set.
(G)	Optimize Y-axis	Checking this will optimize the lower-limit value of the vertical axis by the minimum value of brightness. If it is not checked, the lower-limit value of the vertical axis is fixed at 0.
(H)	Lock Y-axis	Checking this will fix the vertical axis at the minimum/maximum value of brightness for the current frame.



Item	Name	Function
(I)	Export CSV	Exports the brightness distribution by frame in CSV format.
(J)	Reset	Returns the settings to default.
(K)	OK	Applies the settings and closes this screen.
(L)	Cancel	Closes the screen without applying the changed settings.

### 8.3.4. Brightness Change

You can display the changes in brightness of the recorded image and output the brightness value of the specified image range in CSV format.

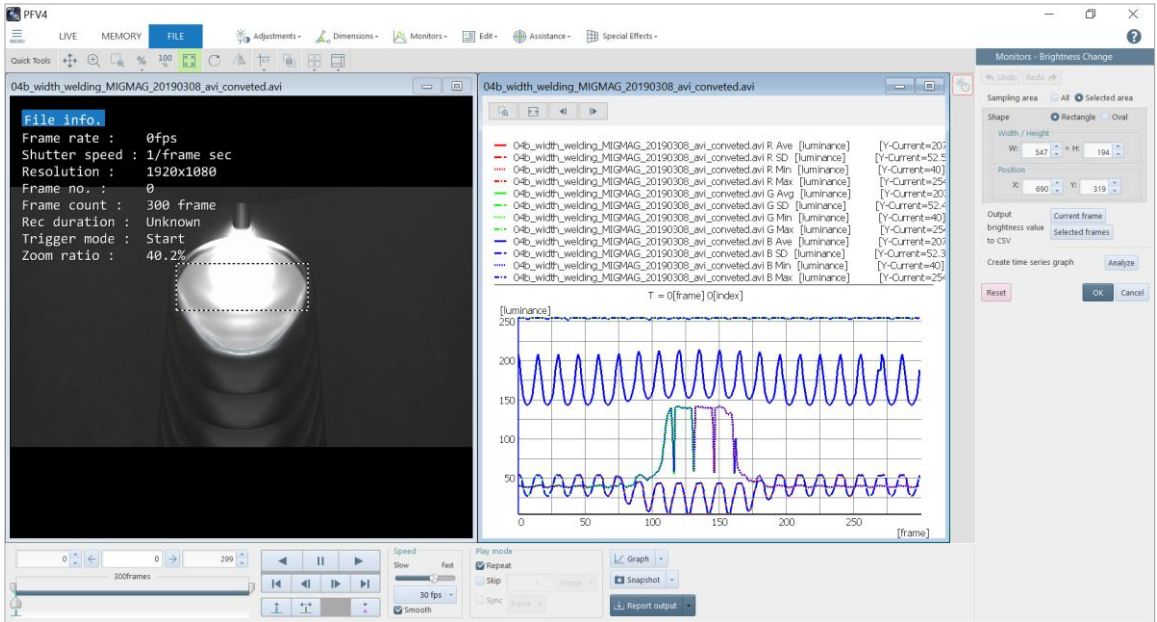

The description of the [Monitors – Brightness Change] screen is as follows.

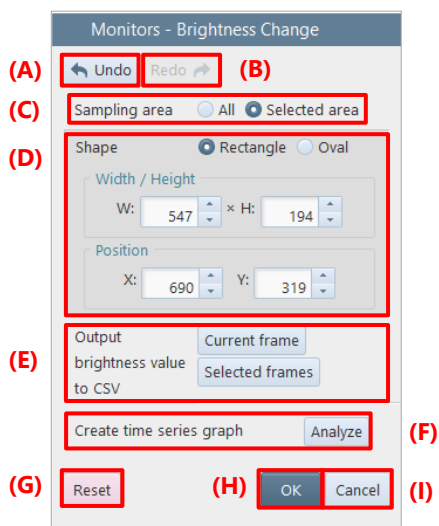

Item	Name	Function	
(A)	Undo	Undoes the previous action.	
(B)	Redo	Redoes the undone action.	
(C)	Sample area	All	Specifies all area as a sampling area.
		Selected area	Specifies the area selected in the “Shape” setting.
(D)	Shape	This setting pane will be displayed when checking “Selected area” in sampling area setting. Select the shape from “Rectangle” and “Oval”. Specify “Width/Height” and “Position” as a numerical value or modifying / moving the sampling area over the image.	
(E)	Output brightness value to CSV	Current frame	Outputs the brightness map of the current frame to CSV.
		Selected frames	Outputs the brightness map of the selected frame set by the playback slider bar on the recording/playback panel to CSV. Outputs the number of CSV files for the selected frames.
(F)	Analyze	Analyzes the time variation of the brightness of the selected area and makes a graph.	
(G)	Reset	Returns the settings to default.	
(H)	OK	Applies the settings and closes this screen.	
(I)	Cancel	Closes the screen without applying the changed settings.	

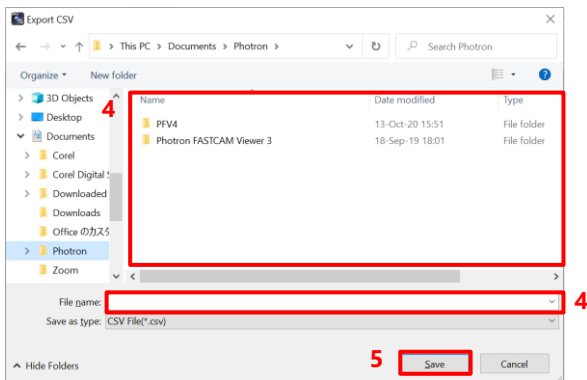
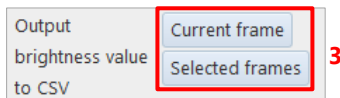
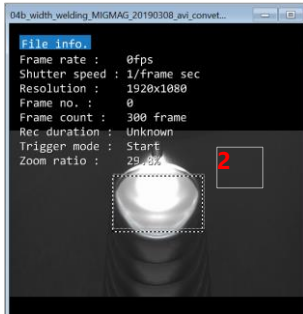
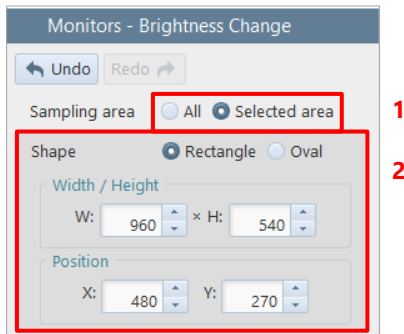

1. Set the Sampling area setting from “All” and “Selected area”.
2. When you check “Selected area”, specify the shape of sampling area.

Select the shape from “Rectangle” and “Oval”.

Specify “Width/Height” and “Position” as a numerical value or modifying / moving the sampling area over the image.

3. Select the frame to output a CSV of the brightness value.
  - Current frame: Outputs the brightness map of the current frame to CSV.
  - Selected frames: Outputs the brightness map of the selected frame set by the playback slider bar to CSV. Outputs the number of CSV files for the selected frames.
4. Select the folder in which to save the CSV file and specify the filename.
5. Click the [Save] button. Then, the CSV data of the brightness value is output.

## [Graph view] screen

Displays the average, standard deviation, minimum and maximum brightness values for each RGB channel in a graph. The horizontal axis shows the frame and the vertical axis shows the value.

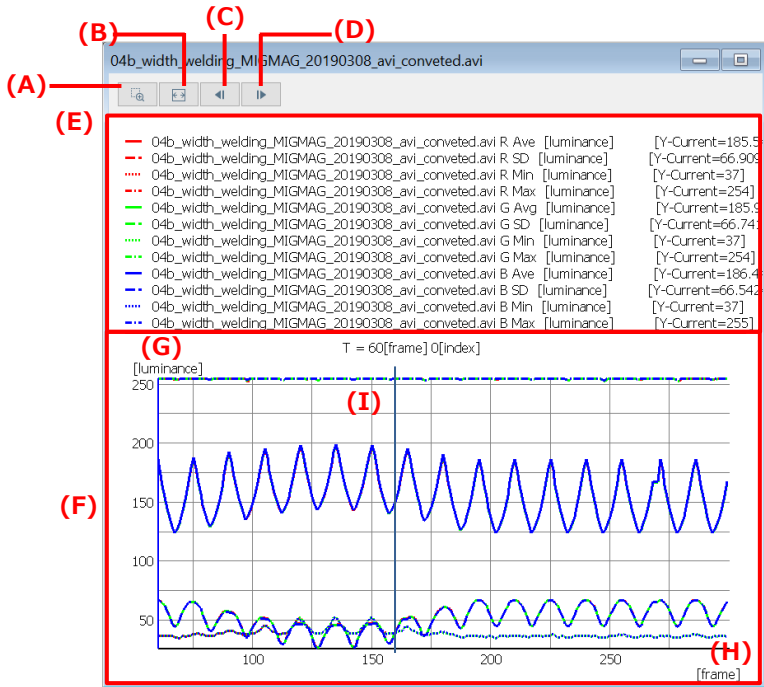

Item	Name	Function
(A)	Enlarge	Click the button to enable its function and drag a desired area. Then the selected area will be enlarged.
(B)	Fit	Clicking this button puts a graph within a graph window.
(C)	Sampling Back	Returns the T-axis in sampling unit and updates the window. Clicking this button while playing back a video stops the playback.
(D)	Sampling Forward	Proceeds the T-axis in sampling unit and updates the window. Clicking this button while playing back a video stops the playback.
(E)	Legend	Displays detailed information of the selected channel's graph.
(F)	Graph	Displays a graph of each channel. Right-click this area displays the menu including [Graph Settings] and [Show buttons]. Clicking [Graph Settings] displays the [Graph Settings] screen. Clicking [Show Buttons] toggles the display of the [Enlarge], [Fit], [Sampling Back], and [Sampling Forward] buttons displayed in the upper left corner of the window.
(G)	Y-axis scale	Displays the scale of the Y-axis.
(H)	T-axis scale	Displays the scale of the time axis.
(I)	Current bar	Displays the current position. When playing back a video, the current bar moves in conjunction. When moving the current bar, the relevant frame of a video will be played back in conjunction.

## Saving brightness change data

Brightness change data can be saved in a CSV file or TEMA format separately from an image. The procedure is described below.

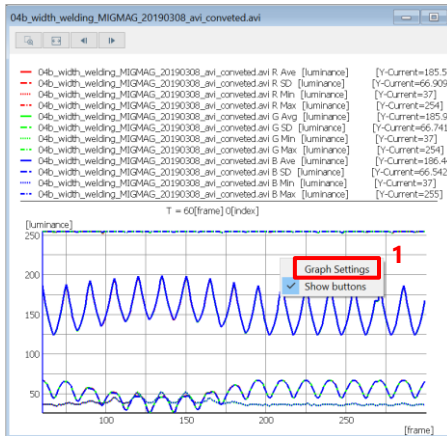

1. Display the brightness change data graph to be saved.

Right-click on the graph, click “Graph Settings” and the [Export] button in the “Graph Settings” dialog.

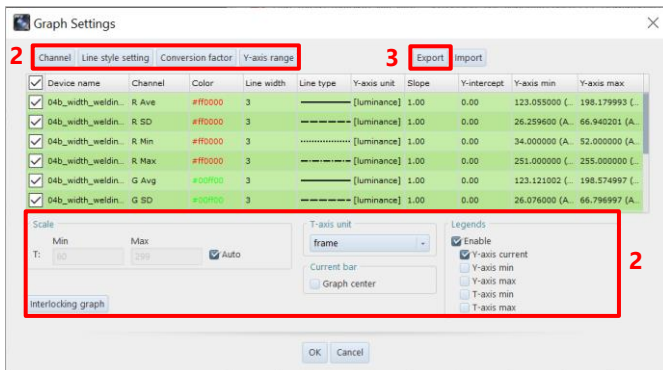

2. Make the graph settings.
3. Click the [Export] button.

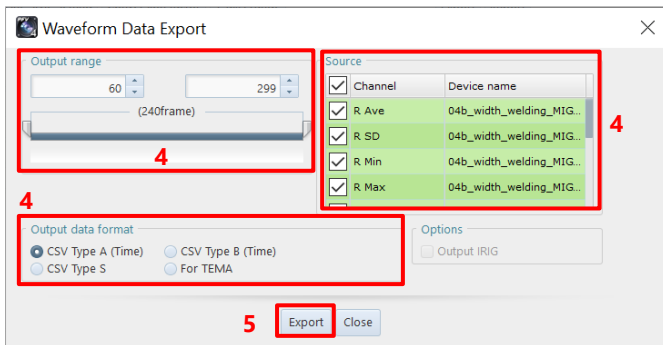

4. Set the output range, source channel, and data format.
5. Click the [Export] button.

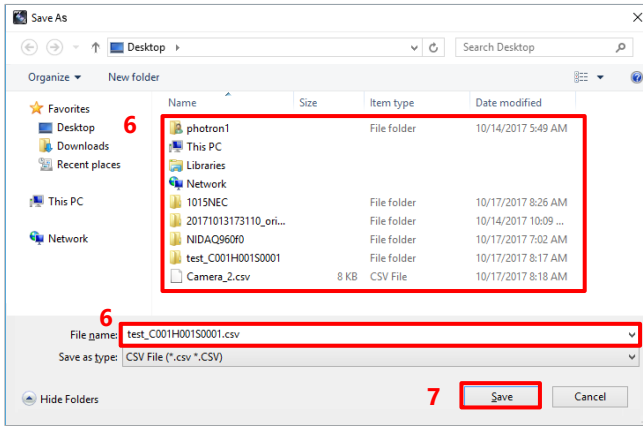

6. Select the folder in which to save the waveform data graph and the filename.
7. Click the [Save] button.  
Then, the waveform data will be downloaded.

## NOTE

If there are waveform data other than the brightness change waveform data, the [Waveform Data Selection] window will appear when clicking the [Graph] button. Select [Luminance] from the pull-down list and output the graph.

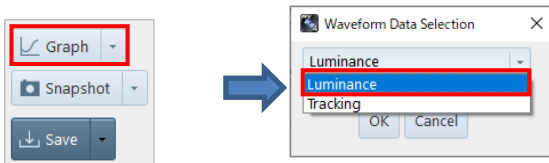

## 8.4. Image Edit Tools

By clicking [Edit] on the tool menu, you can edit an image, namely selecting the image area to save. For details of the tool, see the reference.

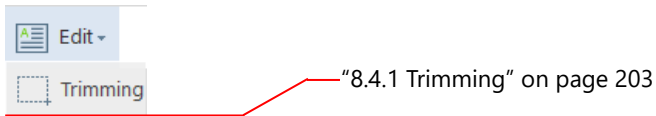

### 8.4.1. Trimming

You can select a custom area within the image to save.

There are two methods: dragging on the screen to specify the area and specifying the resolution and coordinates.

The description of the [Edit - Trimming] screen is as follows.

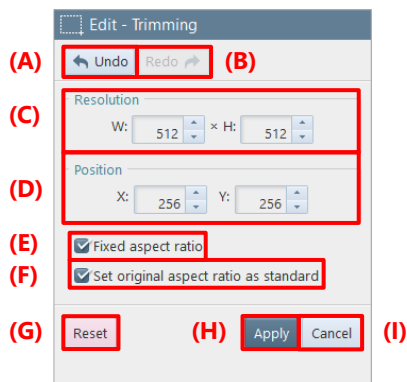

Item	Name	Function
(A)	Undo	Undoes the previous action.
(B)	Redo	Redoes the undone action.
(C)	Resolution	Select the area to save by specifying the size in “Resolution” and the start position in “Position”. You can also drag the mouse on an image to select the area.
(D)	Position	
(E)	Fixed aspect ratio	Checking this will fix the aspect ratio.
(F)	Set original aspect ratio as standard	Checking this will use the aspect ratio based on the original size.
(G)	Reset	Returns the settings to default.
(H)	Apply	Applies the settings and closes this screen. The icon of this function is added to the effect status bar.
(I)	Cancel	Closes the screen without applying the changed settings.

#### NOTE

When multiple cameras are connected, you can make the setting for each camera.

While the multi-lock function is activated, all the cameras are targeted for the setting.

# 8.5. Shooting Assistance Tools

By clicking [Assistance] on the tool menu, you can make the settings for assisting shooting. For details of each tool, see the corresponding reference.

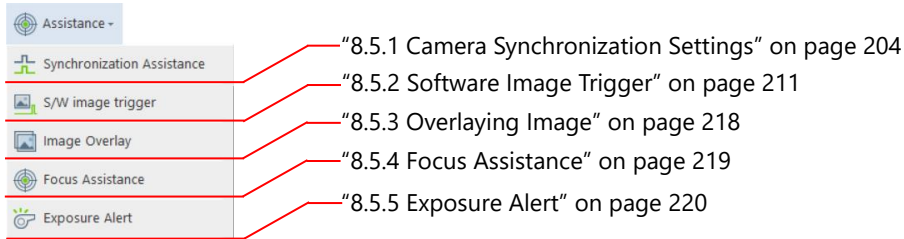

## 8.5.1. Camera Synchronization Settings

You can make the external I/O port setting for using multiple cameras synchronously, from the plug-in. Even if the multiple cameras to synchronize have different exposure times, delay values are adjusted so that they may have the same exposure start point. The multiple target cameras need to be selected beforehand. For a multi-head camera, it will be regarded as a target as long as at least one head is selected.

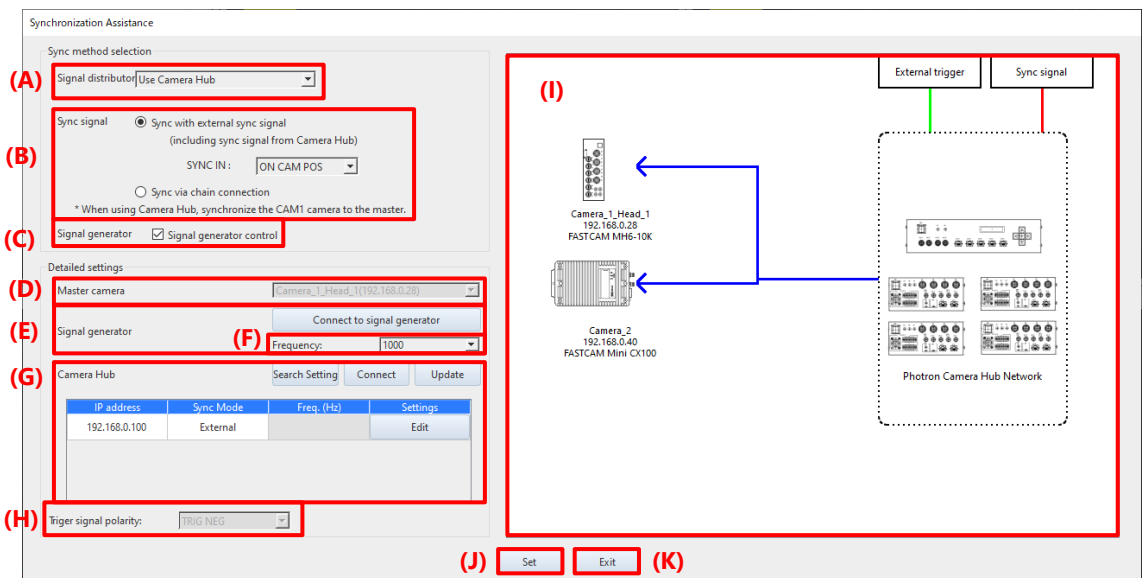

Item	Name	Function
(A)	Signal distributor	Select from the following settings. - Not Used - Use J-BOX (For SA series) - Use Camera Hub (For MH6, Mini series, Mini R5, and Nova series)
(B)	Sync signal	Select the sync signal according to the connection setting. When “Sync with external sync signal” is selected, select “ON CAM POS” or “ON OTHER POS” from the “SINC IN” list to make the setting. This setting is linked to [MENU] - [Configuration] - [I/O].



Item	Name	Function	
(C)	Signal generator	If checked, the signal generator can be used to control the camera.	
(D)	Master camera	Selects the camera that will be the master when chain connection is selected.	
(E)	Signal generator	Click the [Connect to signal generator] button to make the connection with the signal generator.	
(F)	Frequency	Select the frequency of the signal generator from the following values. 1,000, 2,000, 3,000, 4,000, 5,000, 6,000, 7,000, 8,000, 9,000, 10,000	
(G)	Camera Hub	Search Setting	Click the button to display the Camera Hub registration and deletion setting window. For details, see the “Search Setting window” on page 205.
		Connect	Connect to all Camera Hubs.
		Update	Click the button to refresh the Camera Hub list.
		IP address	Displays the IP address of the Camera Hub.
		Sync Mode	Displays the Camera Hub’s sync mode.
		Freq. (Hz)	If the Camera Hub’s sync mode is “Internal”, set the frequency from the following values. 500, 1,000, 2,000, 2,500, 3,000, 4,000, 5,000, 6,000, 8,000, 10,000, 20,000, 40,000, 50,000, 80,000, 100,000
	Edit	Displays the window to set the IP address of Camera Hub.	
(H)	Triger signal polarity	Select from “TRIG POS” and “TRIG NEG”. This setting is linked to [MENU] - [Configuration] - [I/O].	
(I)	Connection diagram	Displays a connection diagram for reference when connecting.	
(J)	Set	Click the button to execute synchronization. The button blinks when there is a change in the connection status.	
(K)	Exit	Click the button to close the Camera Synchronization Settings screen. If synchronization has not been performed, a confirmation message will be displayed asking if synchronization should be performed.	

## NOTE

If image data is recorded in the memory of the camera to be synchronized when you click the [Set] or [Exit] button, the TRIG TTL IN setting cannot be made and the confirmation message shown below will appear. Clicking the [OK] button will erase the data in the memory and start synchronization, so be sure to save the necessary data in advance before setting the synchronization.

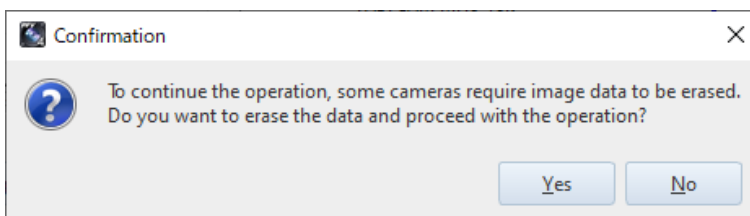

## Search Setting window (Camera Hub)

Click the [Search Settings] button to display the window.

Item	Name	Function
(A)	IP address input field	Enter the IP address of the Camera Hub to be added to the search list. The input value can be from 0 to 255.
(B)	Add	Click the button to display the [Setting] window. Add the IP address of the Camera Hub that you entered.
(C)	IP Address List	Displays the list of Camera Hub IP addresses to search.
(D)	OK	Confirm the setting and exit this window.
(E)	Cancel	Exit this window without confirming the setting.
(F)	OK	Confirm the setting and exit this window.

### NOTE

- The Camera Hub's factory default IP address is "192. 168. 0. 100".
- The IP address can be initialized (192.168.0.100) by powering on the Master Hub with the [Up / Down (▲ / ▼)] control keys pressed. For details, refer to the Photron Camera Hub HW Manual.

## IP Address Setting window (Camera Hub)

Click the [Edit] button under the “Settings” to display the window.  
You can change the IP address of the connected Camera Hub.

Item	Name	Function
(A)	IP Address	Enter the IP address to be changed. The input value can be from 0 to 255.
(B)	OK	Confirm the setting and exit this window.
(C)	Cancel	Exit this window without confirming the setting.



### CAUTION

- If you change the IP address of the Camera Hub, be sure to record the new IP address.  
If the IP address is unknown, you cannot connect the Camera Hub to PFV.
- The IP address initialization procedure is described in the note of “Search Setting window (Camera Hub)” on the previous page.

There are two types of signal distribution devices: Photron J-BOX (hereinafter referred to as J-BOX) and Photon Camera Hub (hereinafter referred to as Camera Hub). Select the signal distributor you have when making the settings.

The following procedure explains the basic settings using the Camera Hub.

See the “Photron J-BOX” and “Photon Camera Hub” Hardware Manual for detailed connection instructions.

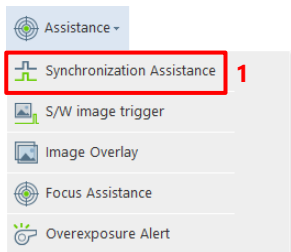

1. Click [Assistance] - [Synchronization Assistance] on the tool menu.

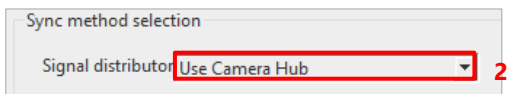

2. In the “Signal distributor” pull-down menu, select the distributor you use, in this example, “Use Camera Hub”.

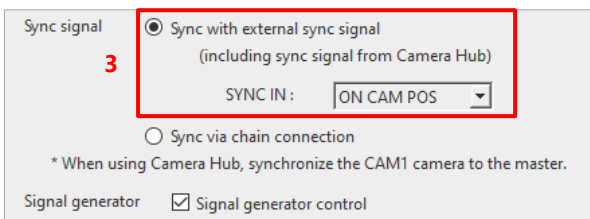

3. Select the sync setting to be used.  
Select “Sync with external sync signal” in this example.  
If you select "Sync via chain connection", select the master camera.

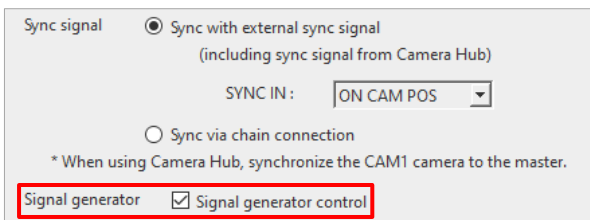

4. Check the [Signal generator] check box.  
Click the [Connect to signal generator] button to connect and set the frequency.  
For signal generators that can be controlled from the PFV, see the NOTE on page 200.

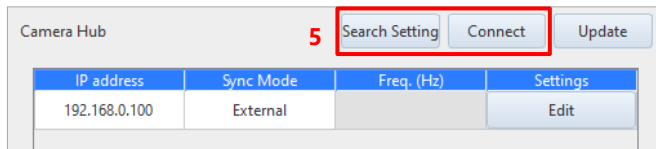

5. Register the Camera Hub's IP address in [Search Setting] and click the [Connect] button.

The Camera Hub’s factory default IP address is “192. 168. 0. 100”.

Once connected, the sync mode will be displayed; for Internal, set the frequency as needed.

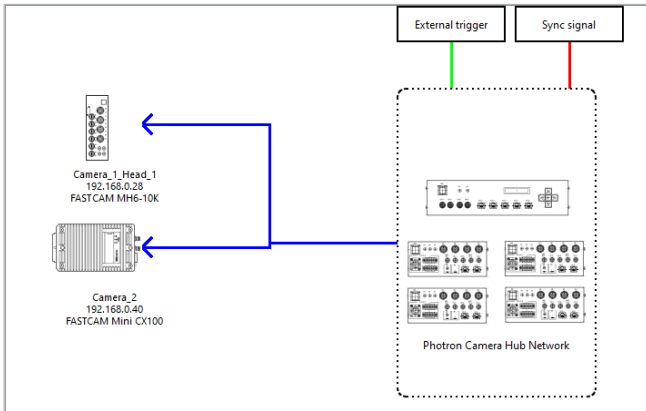

6. Check the updated wiring diagram and connect the ports by viewing the wiring diagram.

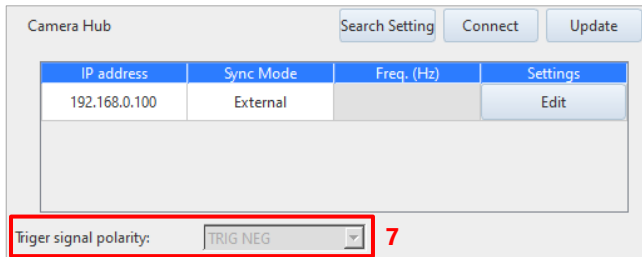

7. Select the trigger signal polarity.

“TRIG POS” and “TRIG NEG” can be selected for the trigger signal polarity.

When [Use Camera Hub] is selected as “Signal distributor”, the trigger signal polarity is fixed as [TRIG NEG].

The TRIG IN settings in [MENU] - [Configuration] - [I/O] can be set here.

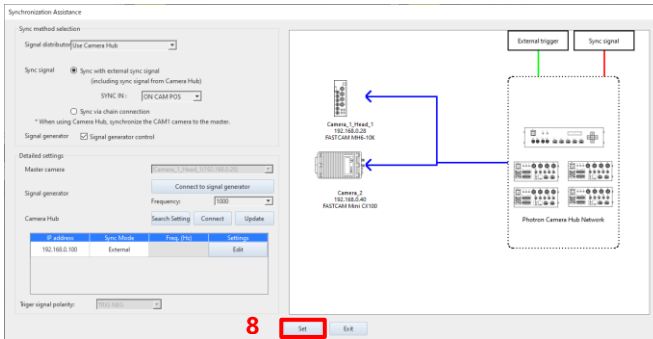

8. Click the [Set] button.

When you click the button, a confirmation message will be displayed depending on the connection status. Follow the message to complete the process.

## CAUTION

- An error occurs in any of the following cases.
  - If any unsupported cameras are connected
  - The connected cameras have different trigger modes.
  - If any connected cameras are in low light mode.
- Depending on the combination of connected camera types, the model that can be set as a master camera varies. The camera that cannot be set as a master camera is not displayed on the “Master camera” list.

- To use an external sync signal

To use an external sync signal, select "Sync with external sync signal". When you select this setting, the connection diagram will be updated and the [Set] button will blink to indicate that synchronization is required.

The example connection diagrams are shown below.

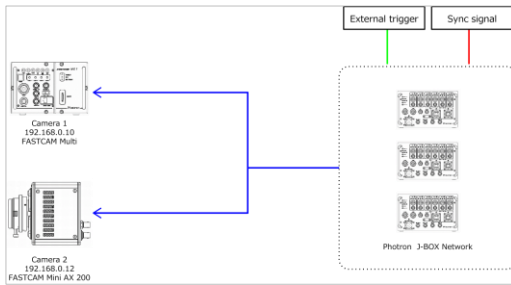

J-BOX connection diagram

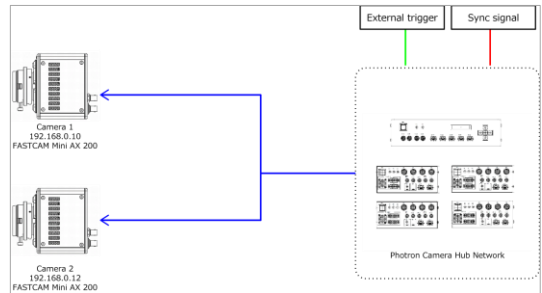

Camera Hub connection diagram

- To use a signal generator

Click the [Signal generator and connection] button. The "Signal Generator and Connection" dialog is displayed. Enter the address and then click the [OK] button.

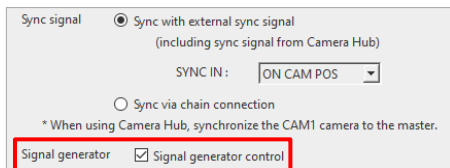

### Window at connection

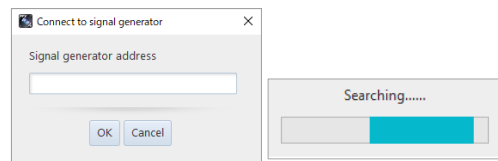

## NOTE

- The following signal generator can be controlled directly from the above screen.  
KEYSIGHT 33210A
  - \* To use this signal generator, it is necessary to install the I/O library suite of the signal generator. Otherwise, the [Connect to signal generator] button is not displayed.
- If the following settings are changed, the [Set] button blinks. Make the synchronization settings again.
  - Frame rate
  - Shutter speed
  - Trigger mode
  - External I/O port settings of cameras
  - Signal delay setting values of cameras
  - "Master camera", "Use J-BOX", "Use Camera Hub", and "External sync signal" settings on window, and port connections on connection diagram
- To cancel the synchronization of the camera, go to [MENU] - [Configuration] - [I/O] and cancel it manually.

## 8.5.2. Software Image Trigger

PFV can record by detecting the change in an image from the live image being displayed and applying a trigger. Specify the change detection method and when the desired threshold value is exceeded the trigger is applied and recording starts.

### ■ Level trigger

When the brightness value in a specified area surpasses or falls below a brightness value specified as the threshold value, or when it deviates from between two points, a trigger is applied.

This is effective for applying a trigger at a change in the image such as when the brightness in a specific area gets brighter or darker than a specific brightness or when the brightness deviates from a specific brightness range.

For color images the function uses an RGB average value.

### ■ Background subtraction

The background image is made up of the per pixel average of brightness values from the first 100 images and, as the threshold value, the amount of change in the image's brightness is calculated.

When the change in the image is detected, the live image and background image are compared by each pixel, and a trigger is applied if that amount of change exceeds the amount of change first calculated as the threshold value.

This method is effective for applying a trigger in a specific area when there is some kind of change in the image where normally there is no change.

### NOTE

#### • Background subtraction concept

First 100 live images are imported. The reference value and the amount of change are calculated per pixel.

**Reference value:** Average value

**Amount of change:** Maximum deviation from average value

} These are the background image values

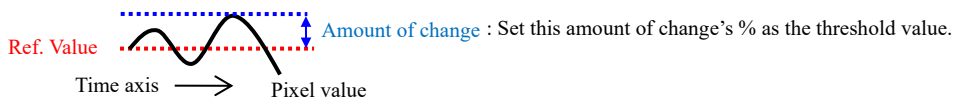

e.g. A pixels average value is 128, its brightest value is 140

Reference value: 128

Amount of change: 12 (140-128)

If the threshold value is set to 150%, the amount of change is 18

The image is detected if the value is less than 110 (128-18) or larger than 146 (128+18).

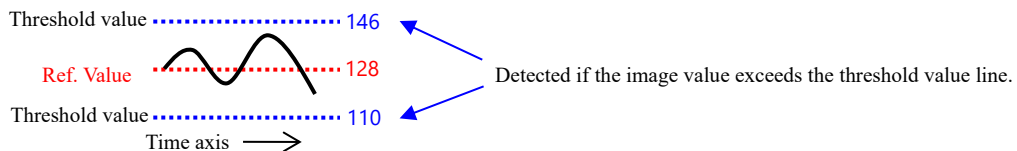

The operation of the software image trigger in the background subtraction method is made by using the following procedure.

1. Click [Assistance] - [Software Image Trigger] on the tool menu.  
The Software Image Trigger window appears, and the function panel will switch to Software Image Trigger Settings.

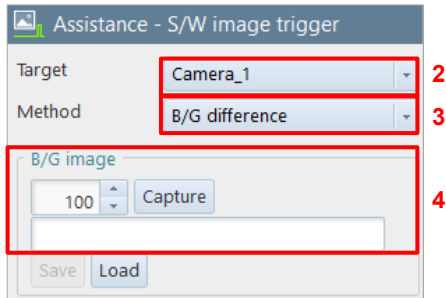

2. Select the target camera of the software image trigger.
3. Select the detection method.
4. Enter the number of frames to acquire the background and click the [Capture] button.

The background acquisition starts, and the button will change to [Stop]. If you want to quit background acquisition, click the [Stop] button.

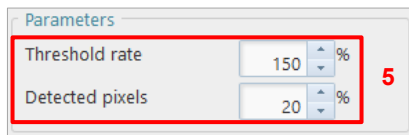

5. Set the threshold rate and detected pixel.

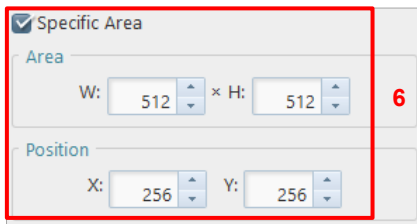

6. Check "Specific Area".  
To specify the detection area, check "Specific Area" and set [Area] and [Position].

7. Click the [Apply] button.

8. Check "Image trigger enabled".  
Check the box when all settings are complete.

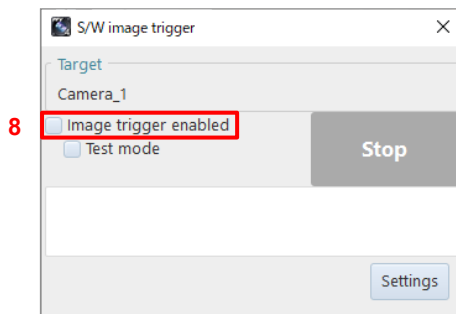

When the conditions are met, the trigger will be executed to start recording and stop playback.





## CAUTION

- The image trigger is not guaranteed to capture 100% of image changes. Depending on the circumstances, this function may overlook image changes, or the trigger may be applied when you feel no change in the image has happened. Fully understand the characteristics of this function and do not use it in situations where a trigger failure is unacceptable.
- Since PFV is handling the processing, a change in the image for all frames cannot be monitored.
- Use this function after fully testing it. The chance of being able to capture the change in an image increases by an even higher percentage by the way the image changes and the settings.
- A delay occurs from when the image changes until the trigger is applied.
- Image changes cannot be detected in the live stop mode state.
- When connecting multiple cameras or multi-head cameras, the image trigger is enabled on the live image of only a single camera (a single head for multi-head cameras).
- After the image trigger is detected, a trigger can be issued for other connected cameras (slave cameras).

## [Software Image Trigger] screen

The description of the [Assistance - Software Image Trigger] screen is as follows.

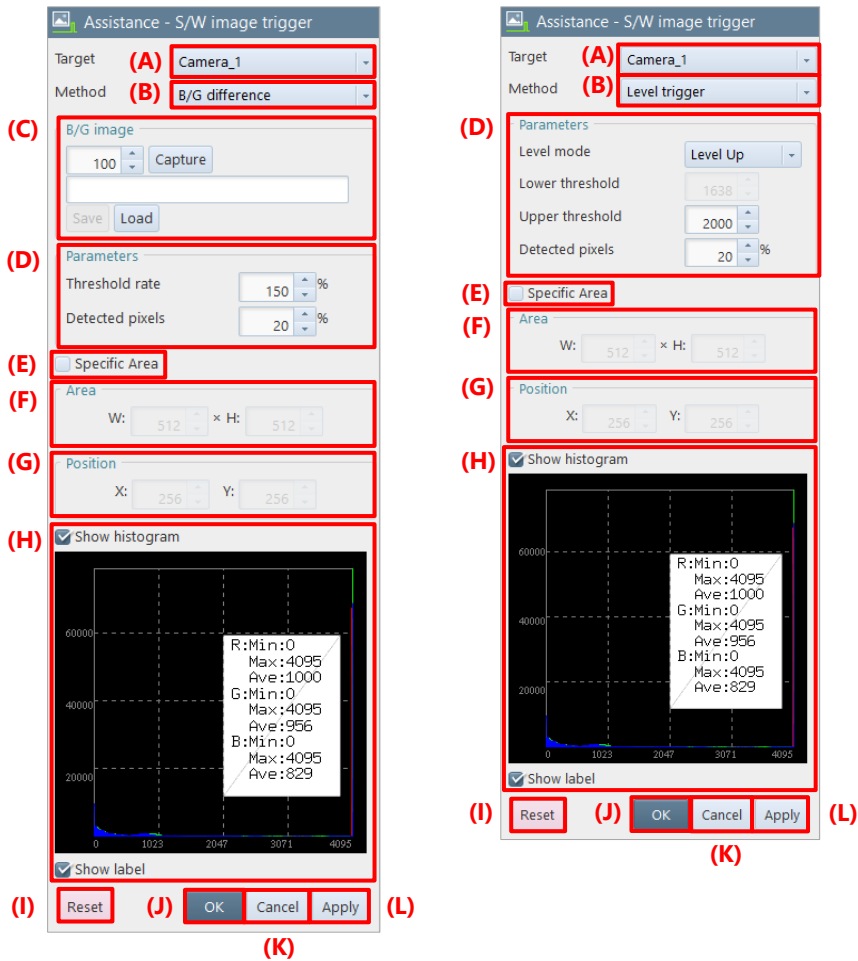

Item	Name	Function		
(A)	Target	Select the camera or file to be used for image trigger detection.		
(B)	Method	Select the image trigger detection method from “Level Trigger” and “B/G Difference”.		
		<table border="1"> <tr> <td>Level trigger</td> <td>This detection method is effective when triggering by the difference in brightness of the image.</td> </tr> <tr> <td>B/G difference</td> <td>This detection method is effective when triggering by the amount of change relative to the background average image.</td> </tr> </table>	Level trigger	This detection method is effective when triggering by the difference in brightness of the image.
Level trigger	This detection method is effective when triggering by the difference in brightness of the image.			
B/G difference	This detection method is effective when triggering by the amount of change relative to the background average image.			
(C)	B/G image	This is displayed when “B/G difference” is selected for the detection method in (B). For details, see the “B/G image”B/G imageB/G imageB/G imageB/G image on page 217.		

Item	Name	Function	
(D)	Parameters	Level mode	This is displayed when “Level Trigger” is selected for the detection method in (B). Select the mode from “Level Up”, “Level Down”, and “Out of Range”.
		Threshold rate	This is displayed when “B/G difference” is selected for the detection method in (B). Adjust the amount of change for the background difference.
		Lower threshold	This is displayed when “Level Trigger” is selected for the detection method in (B). Specify the luminance value that is the threshold for “Level Down” and “Out of Range”.
		Upper threshold	This is displayed when “Level Trigger” is selected for the detection method in (B). Specify the luminance value that is the threshold for “Level Up” and “Out of Range”.
		Detected pixels	Specify how many pixels that match the condition will be used to input the trigger. It is specified as a percentage, not the actual number of pixels. For example, if you specify 100, the trigger will be input when all pixels in the area match the condition. If 50 is specified, the trigger will be input when half of the pixels in the area match the condition. e.g., In the case of 256 x 256, the trigger will be input when 32,768 pixels match the condition.
(E)	Specific Area	The image trigger detection area can be specified by checking this. If unchecked, the entire image will be used as the detection area.	
(F)	Area	Specify the width and height of the image trigger detection area.	
(G)	Position	Specify the coordinate of the image trigger detection area.	
(H)	Show histogram	Specify whether to display the histogram. For monochrome image, the luminance value is displayed. For color image, the following value is displayed. <ul style="list-style-type: none"> <li>• Level trigger: RGB additive mean value</li> <li>• B/G difference: RGB value</li> </ul>	
(I)	Reset	Returns the settings to default.	
(J)	OK	Applies the settings and closes this screen.	
(K)	Cancel	Closes the screen without applying the changed settings.	
(L)	Apply	Applies the settings and closes this screen.	

## [Software Image Trigger] Status display

When clicking [Software Image Trigger], the Software Image Trigger status display appears. If the setting screen is hidden, click the [Settings] button to display it in the function panel.

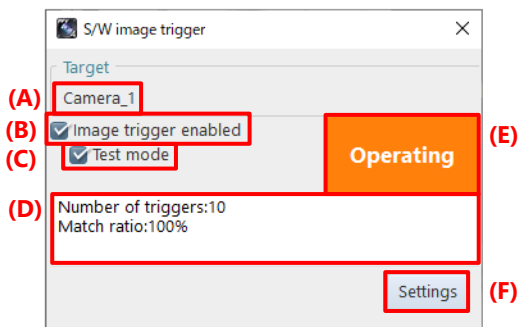

Item	Name	Function
(A)	Target	Displays the camera or file name to be used for image trigger detection.
(B)	Image trigger enabled	Check this box to start the image trigger function.
(C)	Test mode	Check this box to test the operation up to image trigger detection. In test mode, the operation after trigger detection (start recording or stop playback) is not performed.
(D)	Detection status	Displays the detection status of the image trigger.
(E)	Image trigger status	Displays the status of the image trigger. <div style="display: flex; flex-direction: column; gap: 5px;"> <div><span style="background-color: #cccccc; padding: 2px;">Stop</span> : Image trigger detection is not being performed.</div> <div><span style="background-color: #008000; color: white; padding: 2px;">Detecting</span> : Image trigger detection is being performed but is not detected.</div> <div><span style="background-color: #ff8c00; color: white; padding: 2px;">Operating</span> : Image trigger is detected.</div> </div>
(F)	Settings	Displays the setting screen in the function panel.

## B/G image

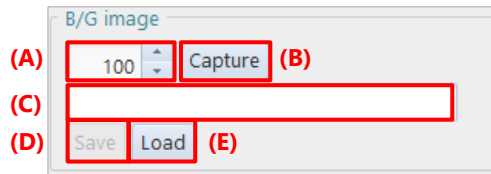

Item	Name	Function
(A)	Number of frames	Specify the number of frames between 1 and 100 for acquiring the background average image / background variation image.
(B)	Capture / Stop	Click this button to start/stop acquisition of the background average image / background variation image.
(C)	Status	Displays the acquisition status of the background average image / background variation image. If there is a difference between the background image and the target image, an error message will be displayed in the status area.
(D)	Save	Saves the background average image / background variation image to the specified folder.  <div style="border: 1px solid orange; padding: 5px;"> <p> <b>NOTE</b></p> <p>The background image is kept for each LIVE/MEMORY/FILE mode, and when saving, the background image of the current mode is saved. When loading, it rewrites the background image of the current mode.</p> </div>
(E)	Load	Loads the background average image/background variation image from the specified folder.

### NOTE

Background data acquired / saved by PFV3 is not supported for loading.

### 8.5.3. Overlaying Image

The referenced image can be overlaid on the currently displayed image. The size, position, and transparency can be set. This function is used to check the difference between images.

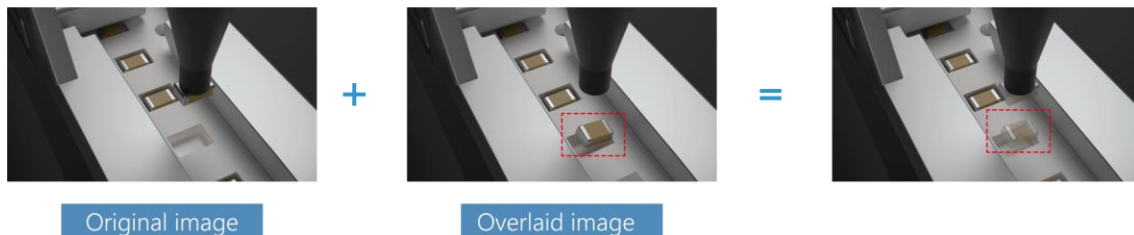

#### CAUTION

When binning is applied to the image, the resolution after binning is applied will be used.

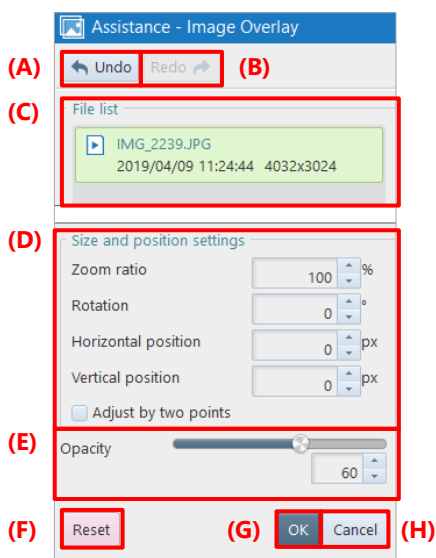

Item	Name	Function
(A)	Undo	Undoes the previous action.
(B)	Redo	Redoes the undone action.
(C)	File list	Select an image to overlay on the displayed image.
(D)	Size and position settings	Specifies zoom ratio and positions to adjust to.
(E)	Opacity	Set the transparency of the overlaid image. You can also drag the mouse on the image to set the transparency.
(F)	Reset	Returns the settings to default.
(G)	OK	Applies the settings and closes this screen.
(H)	Cancel	Closes the screen without applying the changed settings.

## 8.5.4. Focus Assistance

If it is difficult to see that a camera is focused on an image because it is dark, you can use the focus assistance. It calculates the image edge strength and gives colors according to the strength, helping you identify the point of focus visually. The screen is dark if nothing is focused. When you move the lens focus, a colored area will appear. This colored area is in focus.



The description of the [Assistance - Focus Assistance] screen is as follows.

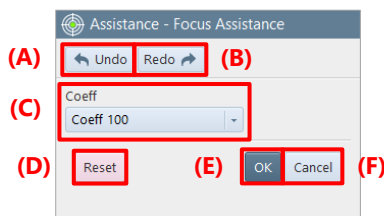

Item	Name	Function
(A)	Undo	Undoes the previous action.
(B)	Redo	Redoes the undone action.
(C)	Coeff	Select a strength coefficient from the list to be displayed by clicking. <div style="border: 1px solid orange; padding: 10px; margin-top: 10px;"> <p><b>NOTE</b></p> <p>The coeff is a coefficient that scales the edge strength. As the value grows larger, the edge strength becomes higher. If, for example, the brightness of the whole image is low, you can make the image more visible by scaling up the edge strength.</p> </div>
(D)	Reset	Returns the settings to default.
(E)	OK	Applies the settings and closes this screen.
(F)	Cancel	Closes the screen without applying the changed settings.

## 8.5.5. Exposure Alert

When enabling the “Overexposure alert”, the areas where the RGB luminance values are higher than the set threshold are displayed in red in LIVE image.

When enabling the “Underexposure alert”, the areas where the RGB luminance values are less than the set threshold are displayed in blue in LIVE image.

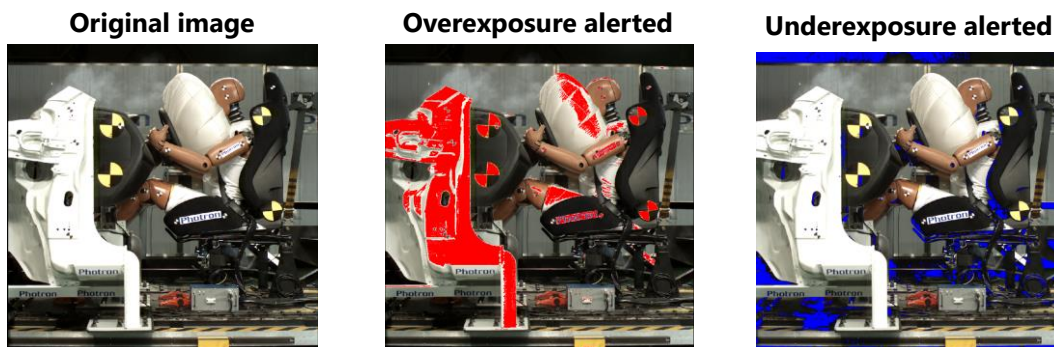

The description of the [Assistance - Exposure Alert] screen is as follows.

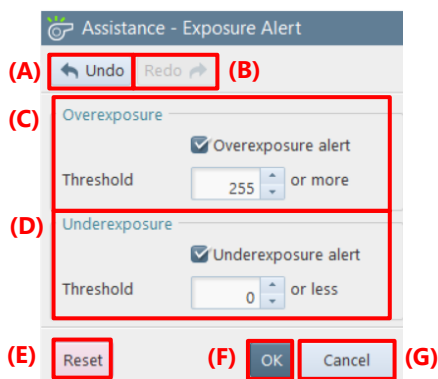

Item	Name	Function
(A)	Undo	Undoes the previous action.
(B)	Redo	Redoes the undone action.
(C)	Overexposure alert	Check this to display the area where the RBG values are higher than the threshold set below in red.
(D)	Underexposure alert	Check this to display the area where the RBG values are less than the threshold set below in blue.
(E)	Reset	Returns the settings to default.
(F)	OK	Applies the settings and closes this screen.
(G)	Cancel	Closes the screen without applying the changed settings.



## 8.6. Special Display Tools

By clicking [Special Effects] on the tool menu, you can make the settings for special displays. For details of each tool, see the corresponding reference.

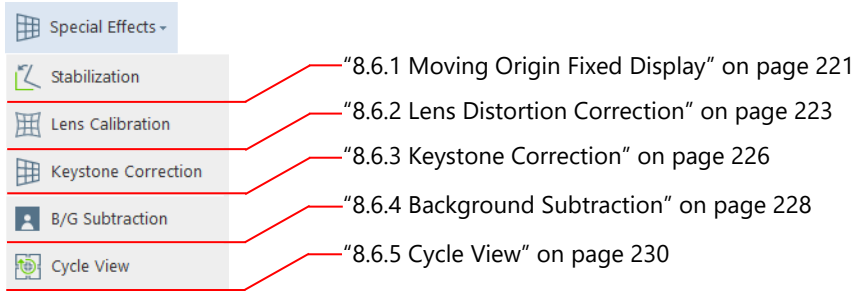

### 8.6.1. Moving Origin Fixed Display

By tracking a target moving in a video, you can achieve the converted video with part of the target fixed. For example, by fixing a swinging subject, you can observe the relative motion around it.

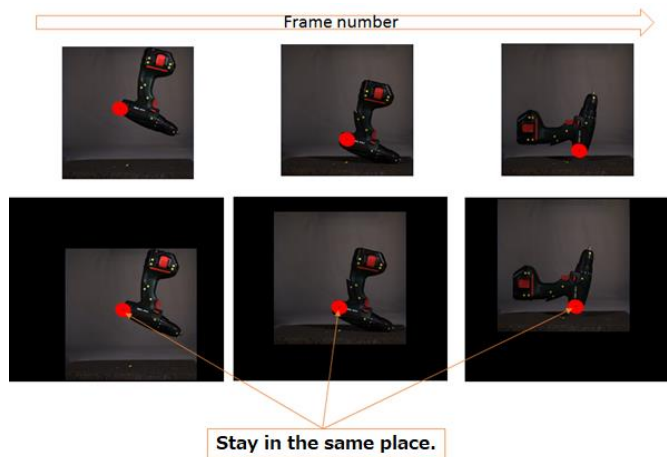

You can also fix the angle of a subject by setting two points (tracking points).

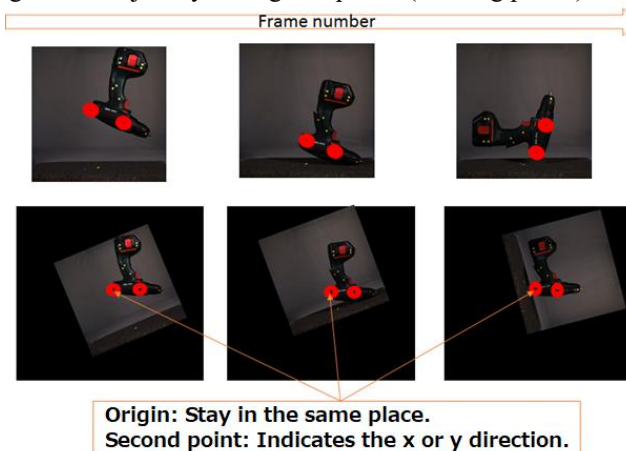

## CAUTION

While this function is running, the following functions will be disabled.

- Keystone correction
- Lens distortion correction

The description of the [Special Effects - Stabilization] screen is as follows.

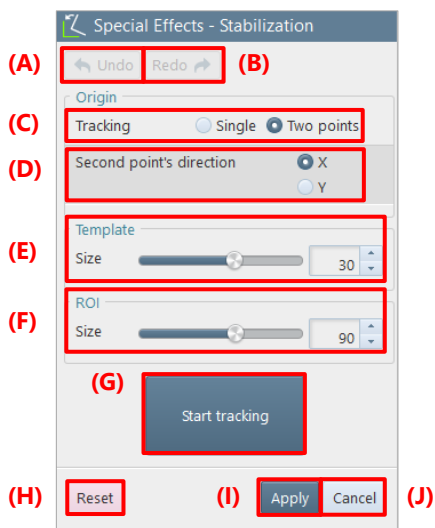

Item	Name	Function
(A)	Undo	Undoes the previous action.
(B)	Redo	Redoes the undone action.
(C)	Tracking	Choose “Single” to set one tracking point or choose “Two points” to set two points.
(D)	Second point's direction	Choose “X” (horizontal direction) or “Y” (vertical direction), which is a tracking result direction for the two tracking points. This item is displayed when “Two points” is selected in “Tracking”.
(E)	Template	Specify a diameter (length of one side of a rectangle) of the template size of the tracking point in pixels. Use the slider or enter a value in the input field.
(F)	ROI	Specify a diameter (length of one side of a rectangle) of the tracing area of the tracking point in pixels. Use the slider or enter a value in the input field.
(G)	Start tracking	Clicking this starts tracking. During tracking, the button is indicated as “Stop tracking”. To quit tracking, click “Stop tracking”.
(H)	Reset	Returns the settings to default. The icon of this function is removed from the effect status bar.
(I)	Apply	Applies the settings and closes this screen. The icon of this function is added to the effect status bar.
(J)	Cancel	Closes the screen without applying the changed settings.

## NOTE

When you drag the template on image with a mouse while this function is activated, the image around the mouse will be enlarged.

## 8.6.2. Lens Distortion Correction

You can perform calibration on a live image to correct the distortion of a lens. The correction value can be saved as a file and loaded to restore the correction in the next use.

The PFV installation disk contains the image data of a checkerboard used for the calibration for distortion correction. Print this to make a correction.



### CAUTION

- If the lens focus is changed, it is necessary to perform calibration again.
- Be careful not to warp or twist the checkerboard.
- Make the brightness of the checkerboard uniform.
- Be careful not to overexpose the checkerboard.
- Shoot the checkerboards to fill the entire screen by changing the positions of the checkerboards so that 30 % or more of the checkerboards are overlapped.
- Shoot at least 12 checkerboards. The maximum number of checkerboards to shoot is 30.
- When shooting the checkerboards, be careful not to focus them on one position in a window.
- Some lenses cannot be calibrated. Therefore, before using a lens, confirm the effects.
- Note that an area with an angle of 40 degrees or more with respect to the line of sight cannot be calibrated in many cases.



### NOTE

- The effect is applied even when you play back the image in MEMORY mode after making the correction. In that case, the icon of this function on the effect status bar is used to apply or cancel the effect.
- This function is also available to the following images.
  - Image zoomed in/out
  - Image rotated
- The accuracy can be increased by shooting two patterns of checkerboards. One pattern is to rotate the checkerboard 45 degrees and face it up 10 to 15 degrees. The other pattern is to rotate the checkerboard 45 degrees to the opposite side and face it down 10 to 15 degrees.
- After saving the correction data into a file, the same correction file can be applied again to the same lens unless the focus is not changed.

**Before correction**



**After correction**

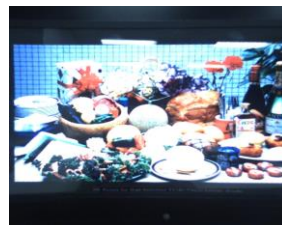

The lens distortion correction is made by using the following procedure.

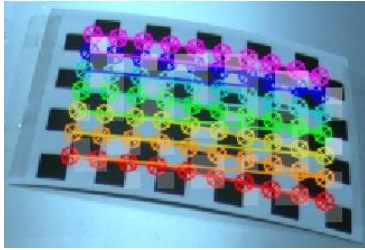

1. Click [Special Effects] - [Lens Calibration] on the tool menu.

2. Click the [Calibrate] button.

The character displayed on the button changes to [Stop], and the automatic capture of the checkerboard starts.

When the checkerboard is projected on a live image, its position will be recognized automatically. When the checkerboard is recognized, points on it and colored lines connecting them will be displayed as shown in the figure.

Even for a monochrome camera, the points and lines of the same colors are displayed.

When the shutter releases, image data is captured, and the position of the checkerboard will be registered on the screen as white points. Repeat this until the number of them reaches the specified one.

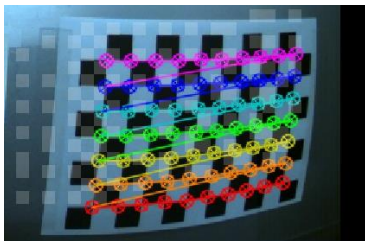

3. Click the [Stop] button.

The automatic capture ends.

If you start the automatic capture again after it stops, it will resume where it quit the last time.

Since measurement result is held for each camera, measurement can be resumed where it was quit the last time, even after the camera is changed.

The description of the [Special Effects - Lens Calibration] screen is as follows.

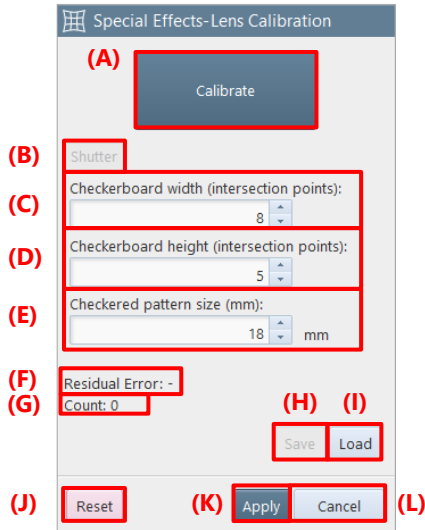

Item	Name	Function
(A)	Calibrate	Clicking this starts the automatic capture of the checkerboard for all the cameras. During the automatic capture, fixing the checkerboard for a certain period of time captures the image data to carry out a measurement. In addition, during the automatic capture, the character displayed on the button changes to "Stop", which stops the automatic capture by being clicked.
(B)	Shutter	By clicking this during the automatic capture, you can capture the image data for the current camera at the desired time.
(C)	Checkerboard width (intersection points)	Set the number of intersection points in the horizontal direction of the checkerboard pattern.
(D)	Checkerboard height (intersection points)	Set the number of intersection points in the vertical direction of the checkerboard pattern.
(E)	Checked pattern size (mm)	Set the size per side of the checkerboard cell, in millimeters.
(F)	Residual Error	Displays the accuracy of the lens distortion correction.
(G)	Count	Displays how many times the shutter was released.
(H)	Save	Clicking this button saves the lens calibration correction values in a file.
(I)	Import	Clicking this button imports the file storing correction values and applies the settings of the file.
(J)	Reset	Returns the settings to default.
(K)	Apply	Applies the settings and closes this screen. The icon of this function is added to the effect status bar.
(L)	Cancel	Closes the screen without applying the changed settings.

### 8.6.3. Keystone Correction

If a subject cannot be shot from its front, you can correct the image inclination by using the Keystone Correction function.

When you click the [Keystone Correction] menu item, a rectangle appears on the screen. Adjusting the rectangle shape makes the correction.

The inclination of an image is corrected by specifying the square as a start point and then altering its shape (trapezoid correction) on the image.

**Before correction**

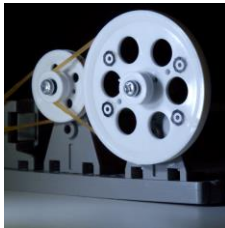

**After correction**

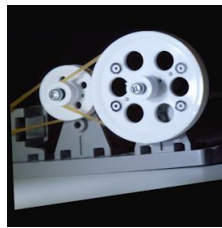

The Keystone correction is made by using the following procedure.

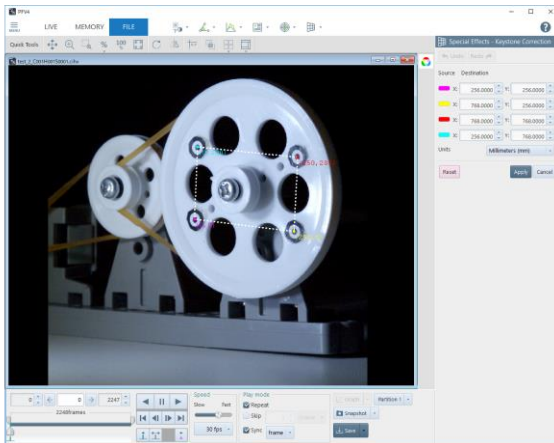

1. Click [Special Effects] - [Keystone Correction] on the tool menu.

The [Special Effects - Keystone Correction] screen is displayed, and a square appears on the image.

2. Drag the square endpoints onto the four reference points that are flush with them and whose relative locations are known.
3. Enter the location information of each endpoint.

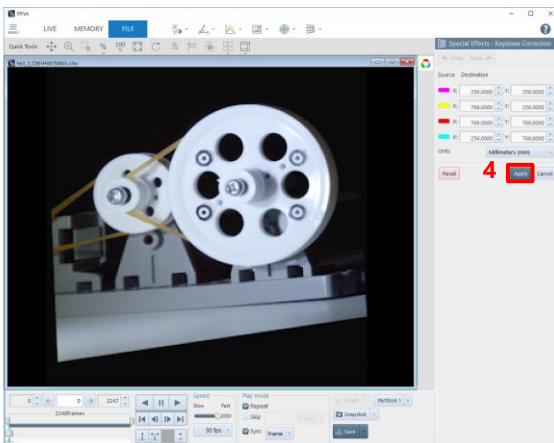

4. Click the [Apply] button.

The screen is corrected as if the plane with the four reference points were shot from the front.

## [Keystone Correction] screen

The description of the [Special Effects - Keystone Correction] screen is as follows.

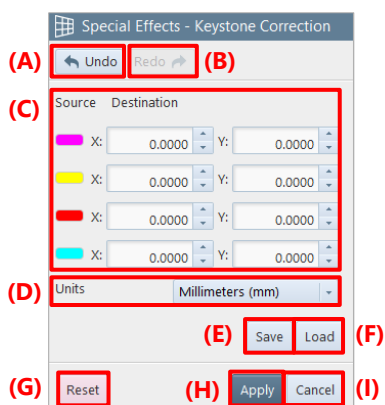

Item	Name	Function
(A)	Undo	Undoes the previous action.
(B)	Redo	Redoes the undone action.
(C)	Source Destination	Enter the real-world coordinate values after converted. The marks of four colors in the left part of the screen show the colors of the coordinates displayed on the image.
(D)	Units	Select a unit to use from the list to be displayed by clicking.  <div style="border: 1px solid orange; padding: 5px;"> <p><b>NOTE</b></p> <p>Units displayed on the list vary according to the settings on the [Customize] screen. For details, see “10.10 Preference” on page 321.</p> </div>
(E)	Save	Saves the 4-point coordinates on the screen and the real-world coordinate values.
(F)	Load	Loads correction values and applies the settings.
(G)	Reset	Returns the settings to default.
(H)	Apply	Applies the settings and closes this screen. The icon of this function is added to the effect status bar.
(I)	Cancel	Closes the screen without applying the changed settings.



### CAUTION

While this function is running, the following functions will be disabled.  
- Lens distortion correction



### NOTE

When you click a point of coordinates while this function is activated, the image around the cursor will be enlarged.

## 8.6.4. Background Subtraction

If a subject to shoot is not easily distinguishable because its background is complicated, you should use the background removal function. When a background on the image is shot and set, the background will be deleted and filled, allowing you to check the subject to shoot clearly.

**Before application of background removal**



**After application of background removal**



### ⚠ CAUTION

If, with this function applied, the following actions are performed, the filled area will be hidden.

- If the resolution is changed in LIVE mode
- If transfer mode (8 bits / actual gradation) is changed in LIVE mode
- If the other mode is established when the resolution is different between LIVE mode and MEMORY mode
- If the binning setting is changed

### ☰ NOTE

This function is also available to the following images.

- Image zoomed in/out
- Image rotated

The background is removed by using the following procedure.

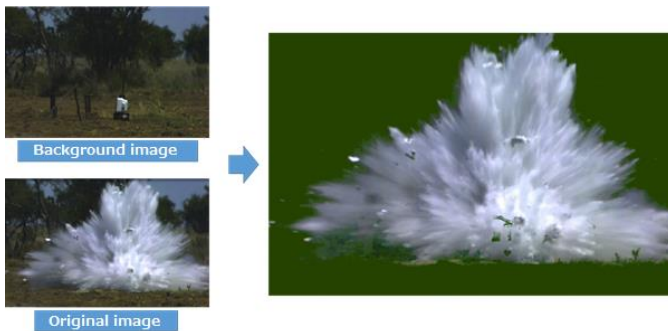

1. Click [Special Effects] - [B/G Subtraction] on the tool menu.

2. Set the method of obtaining the background image and click the [Capture] button.

The background can be obtained from a separate file.

When the processing is complete, the video image will appear with the background filled.



The description of the [Special Effects - B/G Subtraction] screen is as follows.

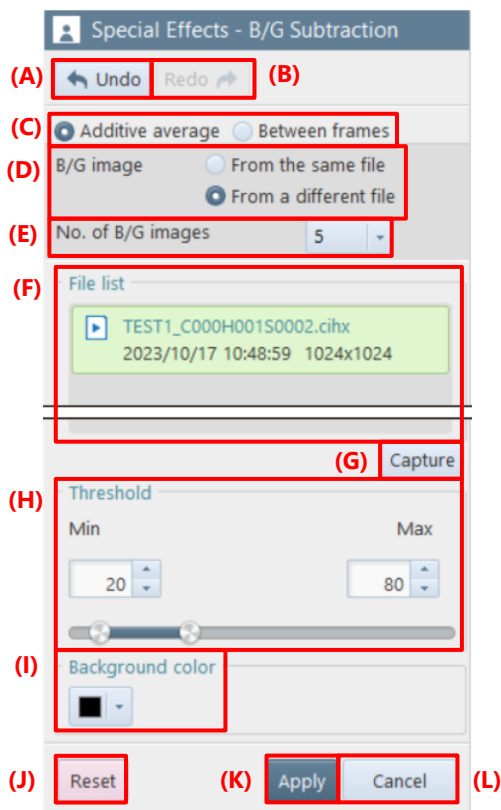

Item	Name	Function
(A)	Undo	Undoes the previous action.
(B)	Redo	Redoes the undone action.
(C)	Method	Select the background image acquisition method.
(D)	B/G image	Select whether the background image for the additive average selection is “From the same file” or “From a different file”.
(E)	No. of B/G images	Select the number of images to be used for the background average image.
(F)	File list	Displays the files that can be selected.
(G)	Capture	Clicking this removes the background.
(H)	Threshold	Set a threshold value to separate the background and others (the foreground). When a pixel value is within the range of the threshold value, it is regarded as the foreground. When out of the threshold value, it is regarded as the background. The threshold value can be set by dragging the knobs on the right and left of the slider or entering the minimum and maximum values directly.
(I)	Background color	Select a color to use for the background from the list to be displayed by clicking.
(J)	Reset	Returns the settings to default.
(K)	Apply	Applies the settings and closes this screen. The icon of this function is added to the effect status bar.
(L)	Cancel	Closes the screen without applying the changed settings.

## 8.6.5. Cycle View

Frames of one video file can be displayed vertically and horizontally. By specifying the number of images to be displayed, one cycle of images can be displayed in a line. For example, this cycle view function is helpful to check phenomena that occur in the same cycle, such as burning of a piston engine.

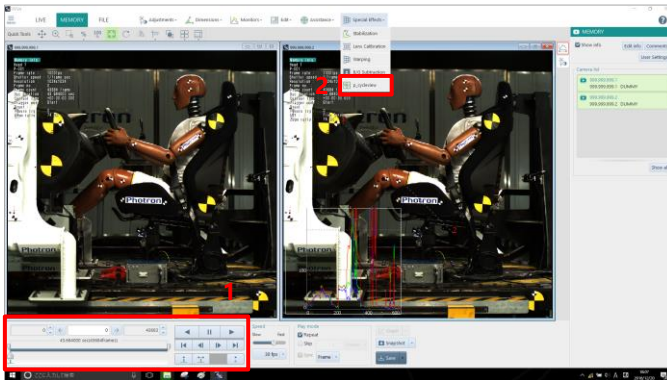

1. Adjust “Number of images”.
2. Click [Special Effects] - [Cycle View].



### CAUTION

The number of images that can be displayed cyclically in horizontal and vertical directions is limited (number of images \* magnification ratio < 32767 pixels). Therefore, adjust “Number of images”, “Number of cycle frames”, and “Magnification ratio”.

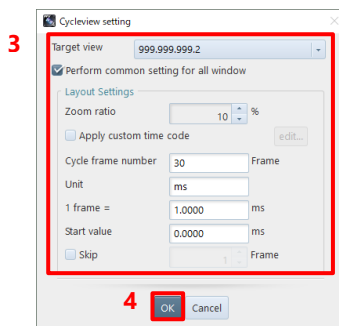

3. Set how to display the images.  
For details, see “[Cycleview setting] screen” on page 231.
4. Click the [OK] button.

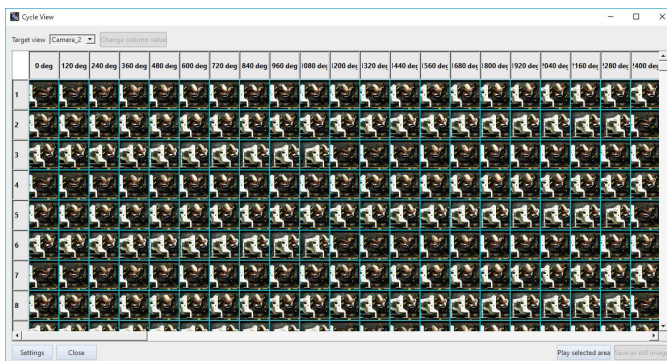

The [Cycle Display] screen is displayed. On this screen, to select one column, click the column. To select multiple columns, click them while pressing the “Ctrl” (or “Shift”) key.

Play back the selected area:  
Select the column and click this button  
Click the [Play] button on Recording/playback panel to play back the selected range.

Save as still image:  
Click this button to save the entire cycle display as a still image.

## [Cycleview setting] screen

The description of the [Cycleview setting] screen, which is displayed by selecting [Cycle View] from [Special Effects], is as follows.

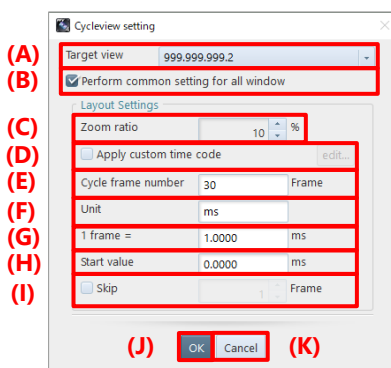

Item	Name	Function
(A)	Target view	Select a camera or file to be displayed cyclically.
(B)	Perform common setting for all window	Selecting this check box applies the common settings to all windows.
(C)	Zoom ratio	Set the zoom ratio to images on the [Cycle View] screen.
(D)	Apply custom time code	Selecting this check box displays the [Time Code Display Settings] screen. For details, see “10.10.1 Time Code Display Settings” on page 322.
(E)	Cycle frame number	Specify the number of columns (number of images to be displayed horizontally) on the [Cycle View] screen.
(F)	Unit	Specify the unit to be displayed in the header of the [Cycle View] screen. Up to 16 characters can be specified.
(G)	1 frame=	Specify the value of each frame to be displayed in the header of the [Cycle View] screen. A value of up to 4 decimal places can be specified. A negative value can also be specified.
(H)	Start value	Specify the start value to be displayed in the header of the [Cycle View] screen. A value of up to 4 decimal places can be specified. A negative value can also be specified.
(I)	Skip	Selecting this check box sets to skip frames (images are displayed cyclically with some images skipped). Specify the number of frames to be skipped in the right input field.
(J)	OK	Applies the settings and closes this screen.
(K)	Cancel	Closes the screen without applying the changed settings.

## [Cycle View] screen

The description of the [Cycle View] screen is as follows.

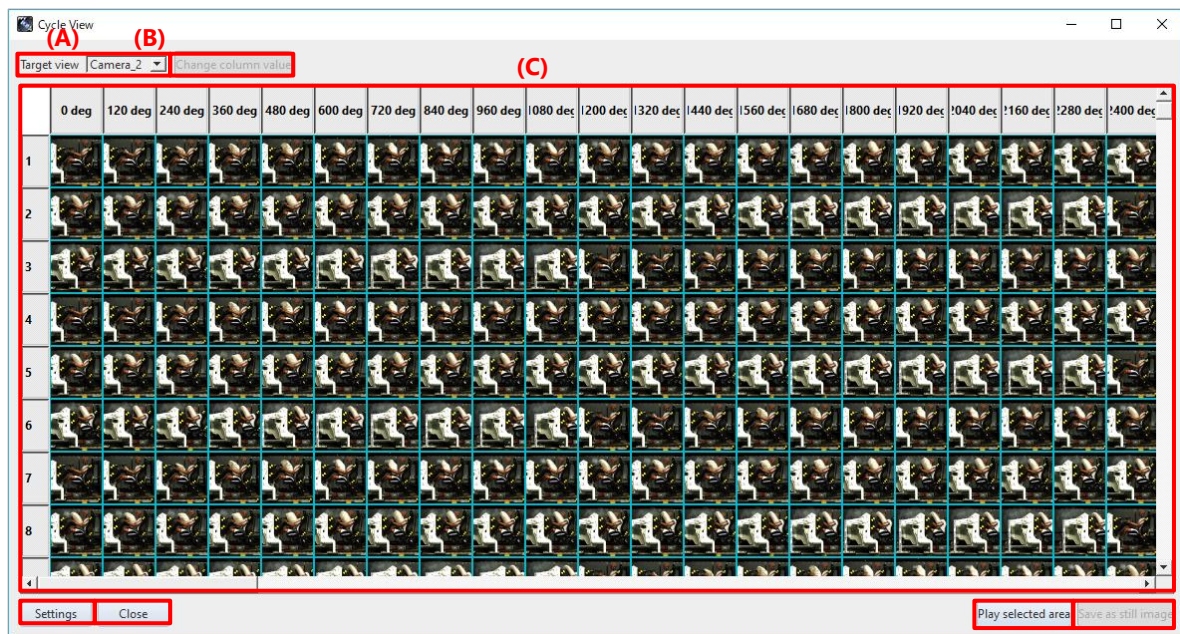

Item	Name	Function
(A)	Target view	Select the item to display from the list displayed by clicking.
(B)	Change column value	Clicking this button displays the number setting screen. On this screen, specify the number of the column header to be changed.
(C)	Cycle view area	Cyclically displays the images set on the [Cycleview setting] screen.
(D)	Settings	Clicking this button displays the [Cycleview setting] screen.
(E)	Close	Closes the [Cycle View] screen.
(F)	Play selected area	Clicking this button displays the [Cycle View Monitoring] screen. For details, see “[Cycle View Monitoring] screen” on page 233.
(G)	Save as still image	Clicking this button saves the displayed cycle display.

## [Cycle View Monitoring] screen

The description of the [Cycle View Monitoring] screen is as follows.

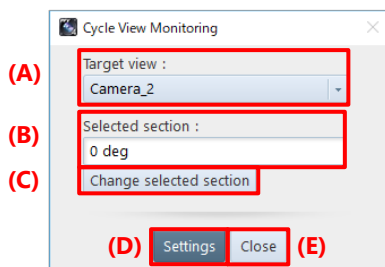

Item	Name	Function
(A)	Target view	Select a camera or file from the list displayed by clicking [▼].
(B)	Selected section	Displays the section selected on the [Cycle View] screen.
(C)	Change selected section	Clicking this button displays the [Cycle View] screen. You can re-set the selected section.
(D)	Settings	Clicking this button displays the [Cycle View] screen.
(E)	Close	Closes the [Cycle View Monitoring] screen.

## 8.7. Add-on Functions

By clicking [Add-ons] on the tool menu, you can call and display the add-ons.  
For details of each tool, see the corresponding reference.

License activation is required to use each function in this chapter. Use the function after performing the license activation in advance. For license activation, go to “9.1.4 License control” on page 292.

If you are using a USB dongle for license management, please keep the USB dongle plugged into your PC.

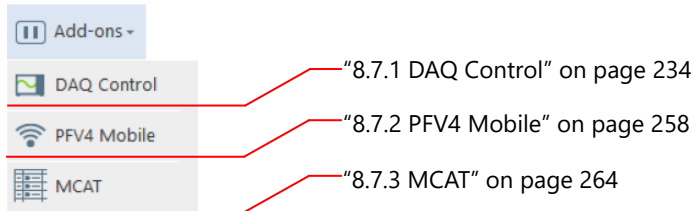

### 8.7.1. DAQ Control

PFV can make the settings suitable for simultaneously recording data in an external waveform equipment (DAQ device) and camera. Since a suitable connection terminal is displayed, wiring work that tends to become complicated can be done smoothly.

When shooting with this function activated, the same content is also recorded in DAQ device automatically. The following DAQ device is supported.

- National Instruments  
NI USB-6251, NI USB-6356, NI USB-6361, NI USB-6363, NI USB-6366
- YOKOGAWA Test & Measurement Corporation  
DL350, DL850, DL850E, DL850V, DL850EV, DL950
- Graphtec Corporation  
GL980, HV GL2000, GL900

#### CAUTION

- Download and install the USB driver from the website of the DAQ device vendor beforehand.
- For details on how to connect and set up when using YOKOGAWA DAQ and GL DAQ, refer to the quick guide in the [Doc] – [English] – [DAQ\_Quick\_Guide] folder of the PFV installation DVD.
  - YOKOGAWA\_DAQ\_Connection\_QuickGuide\_Mini\_Nova\_ver.XX.pdf
  - GL\_DAQ\_Connection\_QuickGuide\_Mini\_Nova\_ver.XX.pdf
  - GL\_DAQ\_Connection\_QuickGuide\_SA\_MH\_Multi\_ver.XX.pdf
- When using a “FASTCAM Mini” or “FASTCAM Nova” series, take “General Out 1” as “OUTPUT 1”, “General Out 2” as “OUTPUT 2”, and “Trigger TTL IN” as “INPUT 2” in the diagram of connection on the next page and later.
- Recording must be continued till it ends when using DAQ control. Stopping recording on the way can lead to an error or generate a displacement between the image and waveform.
- Supported modules for YOKOGAWA DAQ and GL DAQ are as follows. Contact our technical personnel for details.
  - YOKOGAWA: Voltage, Temperature, and Strain (All support level triggering)
  - GL: Voltage, Temperature, Humidity, and RMS (Only the Voltage module supports level triggering)

### Connecting an NI DAQ to a camera (shooting in manual mode)

To start shooting at any given time, connect an NI DAQ to a camera as follows.

- Supported models: NI USB-6251, NI USB-6356, NI USB-6361, NI USB-6363, NI USB-6366

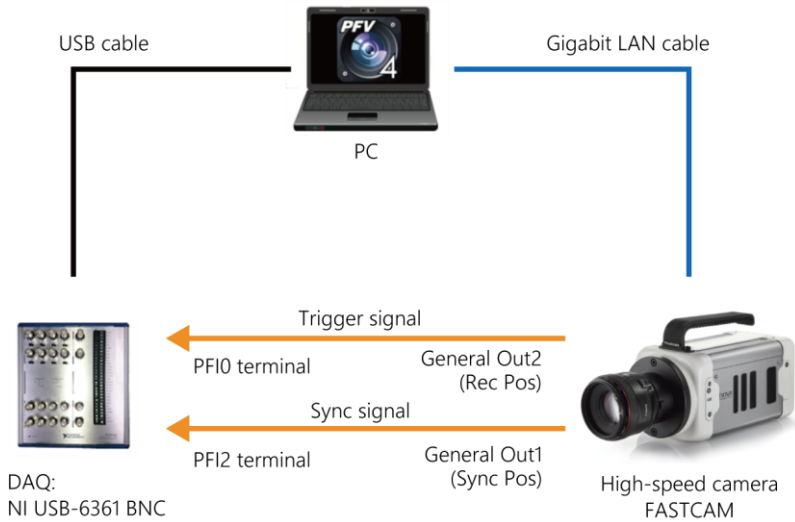

### CAUTION

- Trigger modes other than “Start”, “Center”, “End”, and “Manual” cannot be used.
- To use the “Manual” trigger, the pre-recording duration must be two frames or more.

### Connecting an NI DAQ to a camera (shooting in random reset mode)

To start shooting in random reset mode by clicking the [Record] button of PFV, connect an NI DAQ to a camera as follows.

- Supported models: NI USB-6251, NI USB-6356, NI USB-6361, NI USB-6363, NI USB-6366
- Supported cameras: FASTCAM Nova, FASTCAM Multi, FASTCAM Mini AX, FASTCAM Mini WX

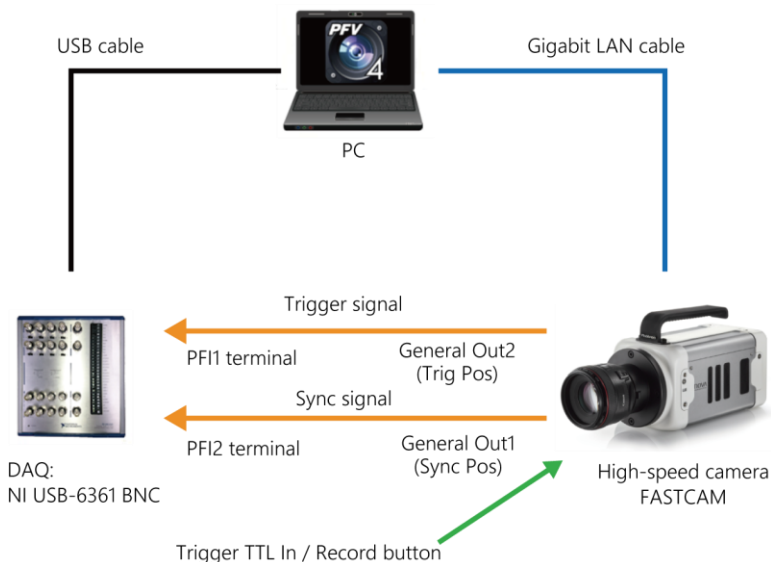



## Connecting an NI DAQ to a camera (shooting while determining the level)

To start/stop shooting when the waveform data input to an NI DAQ exceeds or falls below the specified voltage, connect an NI DAQ to a camera as follows.

- Supported models: NI USB-6251, NI USB-6356, NI USB-6361, NI USB-6363, NI USB-6366

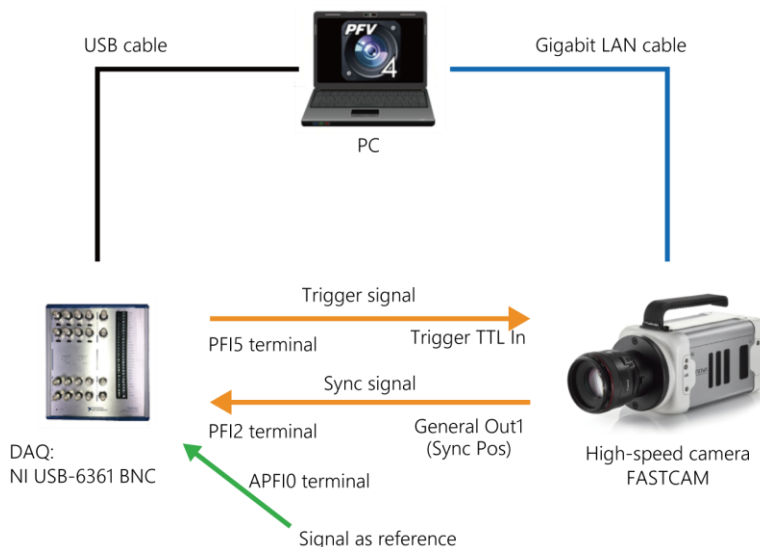

### CAUTION

- In shooting while determining the level, a trigger is determined by using a signal to either “APFIO” terminal or “Dev1/ai0 to 15” terminals. If the “Dev1/ai0 to 5” terminals are used, only their channels can be measured. Therefore, use the “APFIO” terminal basically.
- Trigger modes other than “Center”, “End”, and “Manual” cannot be used.
- To use the “Manual” trigger, the pre-recording duration must be two frames or more.
- When recording while determining the level, the “APFIO” terminal is used, but some models do not have the “APFIO” terminal. In this case, you need to jumper “USER1” and “APFIO” on the terminal block on the right side of the NI DAQ unit. Contact our technical personnel for details.



## Connecting a YOKOGAWA DAQ to a camera (shooting in manual mode)

To start shooting at any given time, connect a YOKOGAWA DAQ to a camera as follows.

- Supported models: DL350, DL850, DL850E, DL850V, DL850EV, DL950

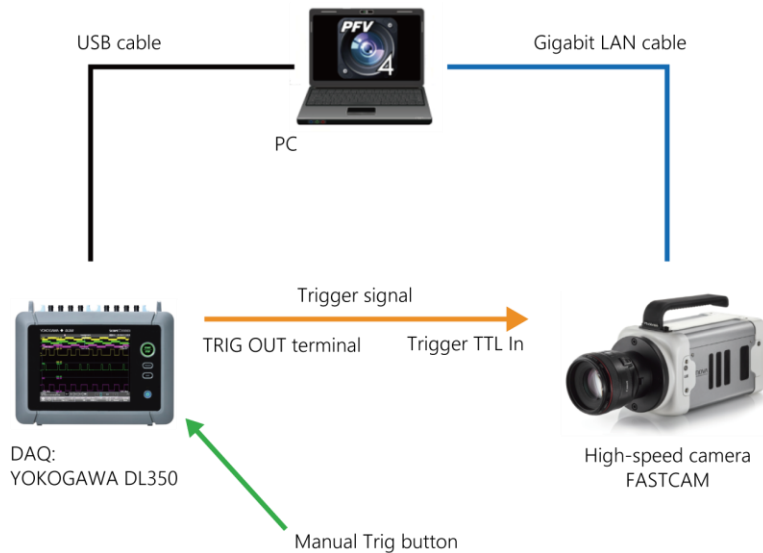

### CAUTION

- Trigger modes other than “Start”, “Center”, “End”, and “Manual” cannot be used.
- To use the “Manual” trigger, the pre-recording duration must be two frames or more.
- When using XViewerEYE made by YOKOGAWA Test & Measurement, input the synchronization signal of the camera to any of the channels.
- When using DL850/DL950, a USB(A)-USB(B) cable is required.
- When using DL350, a USB(A)-USB(MiniB) cable is required.

In addition, the trigger signal output terminal of the DL350 is a terminal block. A cable that splits the BNC terminal into lead wires is required, and it is connected as shown below.

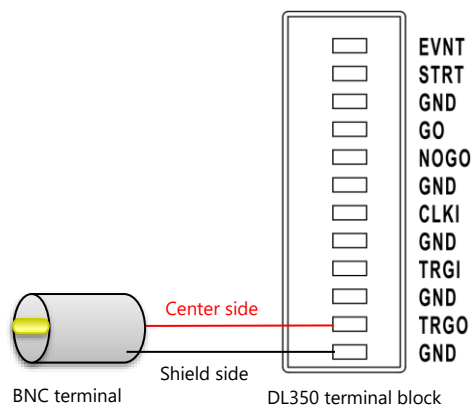

### Connecting a YOKOGAWA DAQ to a camera (shooting while determining the level)

To start/stop shooting when the waveform data input to a YOKOGAWA DAQ exceeds or falls below the specified voltage, connect a YOKOGAWA DAQ to a camera as follows.

- Supported models: DL350, DL850, DL850E, DL850V, DL850EV

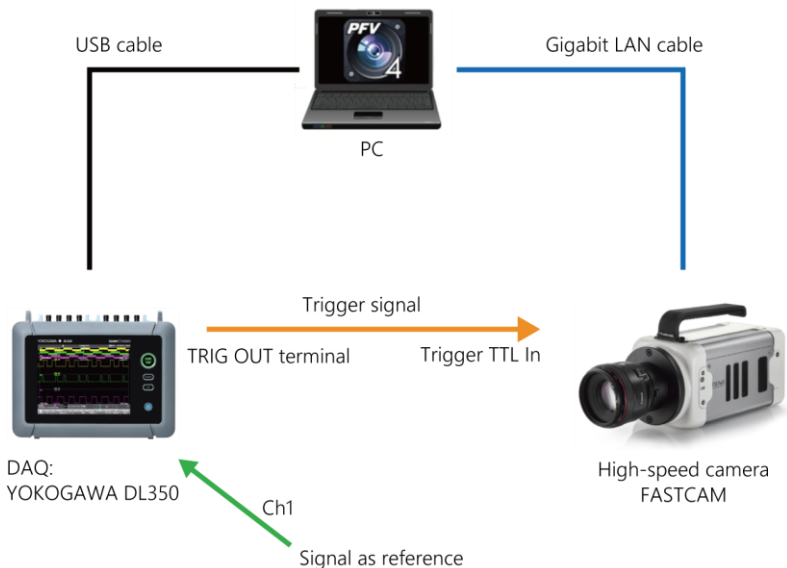

### Connecting a GRAPHTEC DAQ to a camera (shooting in manual mode)

To start shooting at any given time, connect a GRAPHTEC DAQ to a camera as follows.

- Supported models: GL980, HV GL2000, GL900

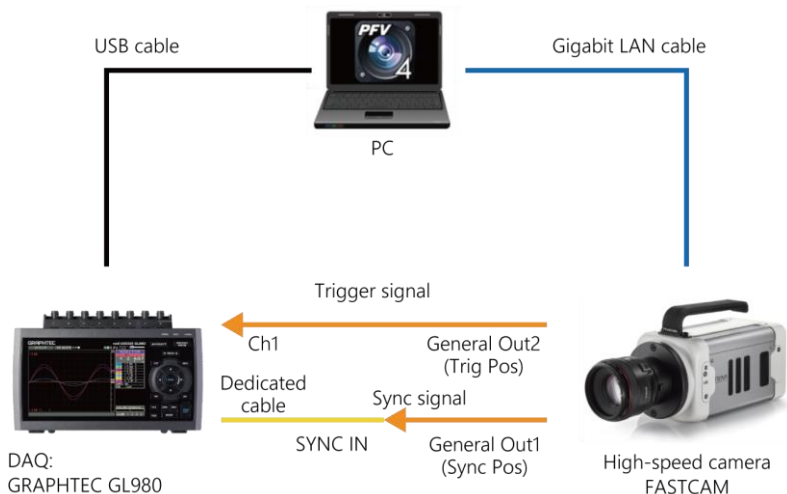

### CAUTION

- Trigger modes other than “Start”, “Center”, “End”, and “Manual” cannot be used.
- To use the “Manual” trigger, the pre-recording duration must be two frames or more.
- The maximum recordable frame count when using random reset trigger is calculated by “the number of frames per recording” x “the times of recording”.

### Connecting a GRAPHTEC DAQ to a camera (shooting in random reset mode)

To start shooting in random reset mode by clicking the [Record] button of PFV, connect a GRAPHTEC DAQ to a camera as follows.

- Supported models: GL980, HV GL2000, GL900
- Supported cameras: FASTCAM Nova, FASTCAM Multi, FASTCAM Mini AX, FASTCAM Mini WX

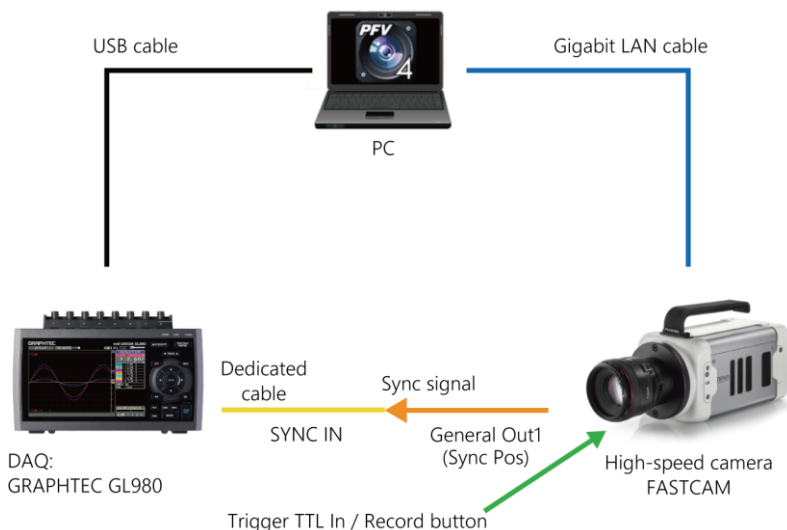

### Connecting a GRAPHTEC DAQ to a camera (shooting while determining the level)

To start/stop shooting when the waveform data input to a GRAPHTEC DAQ exceeds or falls below the specified voltage, connect a GRAPHTEC DAQ to a camera as follows.

- Supported models: GL980, HV GL2000, GL900

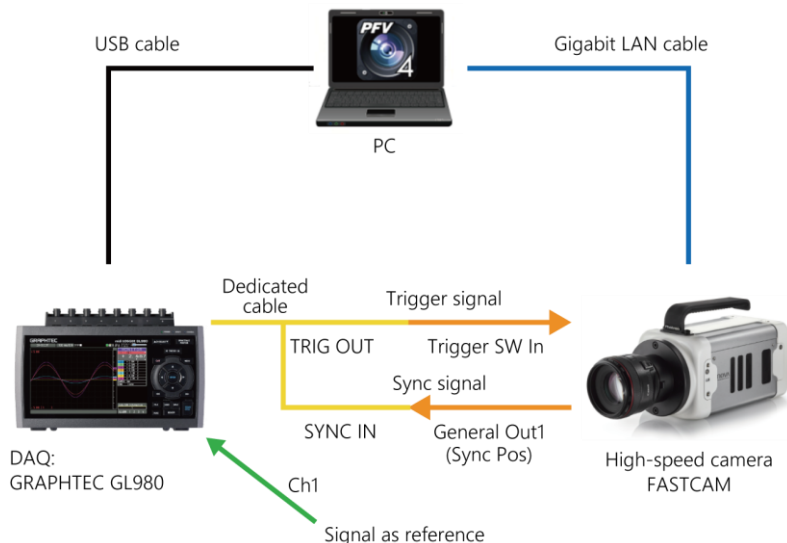

## DAQ device settings

This function can be used in LIVE mode.



### CAUTION

“Center”, “End”, and “Manual” modes are available.

The Mini AX series, Mini WX series, and Multi can also be used in “Random reset” mode.

2

4

NI DAQ

1. Click [Add-ons] - [DAQ Control] on the tool menu.

The [DAQ Device Select] screen is displayed.

2

3

4

GRAPHTEC DAQ

2. Select a DAQ device to use.
3. Configure the connection setting.

4. Click the [OK] button.  
The [DAQ Device Configuration] screen is displayed.

2

3

4

YOKOGAWA DAQ

4. Click the [OK] button.



### REFERENCE

For details of the [DAQ Device Select] screen, see “[DAQ Device Select] screen” on page 242.

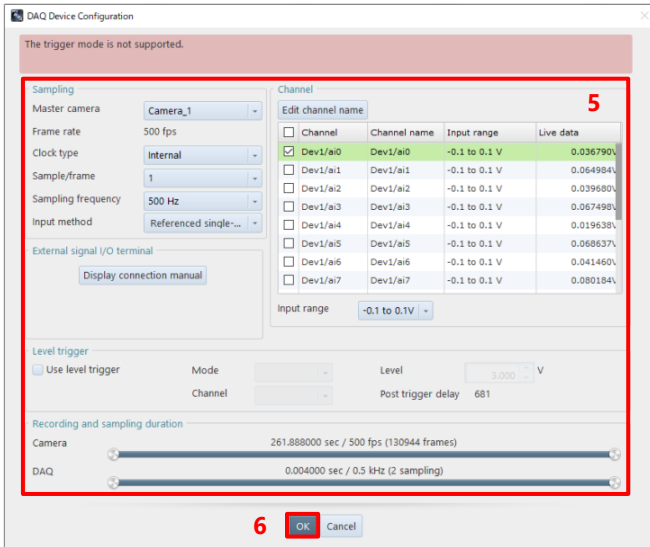

5. Make the DAQ device settings.
6. Click the [OK] button.

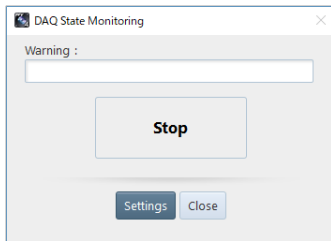

The [DAQ State Monitoring] screen is displayed and recording to the DAQ device starts.

## REFERENCE

- For details of the DAQ Device settings, see “[DAQ Device Configuration] screen” on page 244.
- For details of the [DAQ State Monitoring] screen, see “[DAQ State Monitoring] screen” on page 246.

## [DAQ Device Select] screen

Following describes the [DAQ Device Select] screen to be displayed by clicking [Add-ons] - [DAQ Control] on the tool menu.

### ■ For NI DAQ

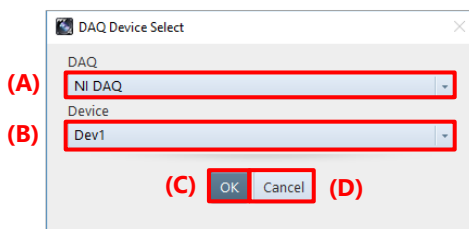

Item	Name	Function
(A)	DAQ	Choose the DAQ type to use from the list to be displayed by clicking.
(B)	Device	Choose a device to be used by the selected DAQ device from the list to be displayed by clicking.
(C)	OK	The [DAQ Device Configuration] screen corresponding to the selected device is displayed. For details of the [DAQ Device Configuration] screen, see “[DAQ Device Configuration] screen” on page 244.
(D)	Cancel	Closes the screen without applying the changed settings.

### ■ For GRAPTEC DAQ

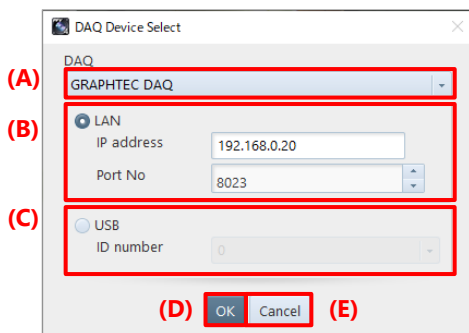

Item	Name	Function
(A)	DAQ	Choose the DAQ type to use from the list to be displayed by clicking.
(B)	LAN	Specify IP address and port number for LAN connection. The default setting is IP address: 192.168.0.20, Port No.: 8023.
(C)	USB	Specify ID number for USB connection.
(D)	OK	The [DAQ Device Configuration] screen corresponding to the selected device is displayed. For details of the [DAQ Device Configuration] screen, see “[DAQ Device Configuration] screen” on page 244.
(E)	Cancel	Closes the screen without applying the changed settings.

■ For YOKOGAWA DAQ

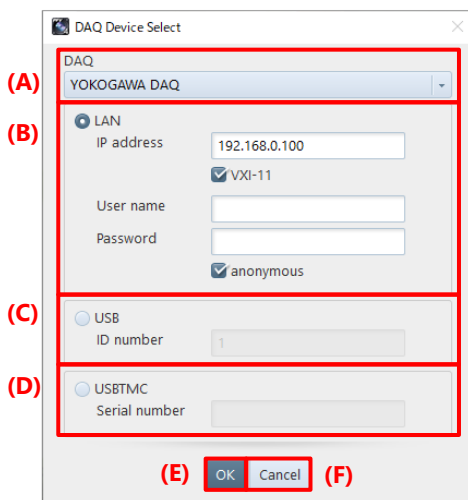

Item	Name	Function
(A)	DAQ	Choose the DAQ type to use from the list to be displayed by clicking.
(B)	LAN	Specify the settings for LAN connection. The default setting is IP address: 192.168.0.100 VXI-11: Check this to use the ethernet protocol VXI-11. User name: Specify the user name. Password: Enter the password. Anonymous: Check this to connect without the user name and the password.
(C)	USB	Specify ID number for USB connection.
(D)	USBTMC	Enter the serial number for USBTMC connection.
(E)	OK	The [DAQ Device Configuration] screen corresponding to the selected device is displayed. For details of the [DAQ Device Configuration] screen, see “[DAQ Device Configuration] screen” on page 244.
(F)	Cancel	Closes the screen without applying the changed settings.

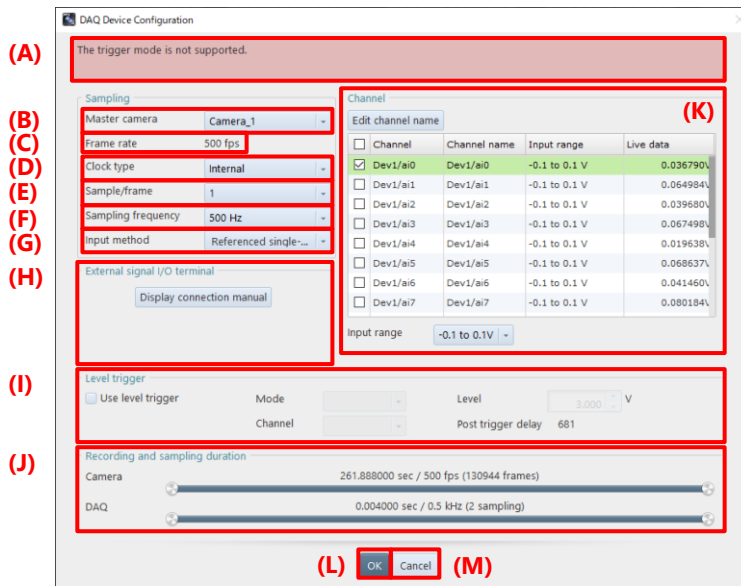

## [DAQ Device Configuration] screen

Following describes the [DAQ Device Configuration] screen.



Item	Name	Function
(A)	Status message	Shows an alert of the camera status or DAQ setting.
(B)	Master camera	Displays the camera connected to the DAQ device. Select a desired camera from the list by clicking. For details, see “10.6.1 Setting External I/O Port” on page 310.
(C)	Frame rate	Displays the frame rate of the master camera.
(D)	Clock type	Operating clock type (clock in a DAQ device or clock signal input from the outside). When selecting “External” for [Clock type], connect and input a “SYNC POS” signal of a camera to the “Sync Signal” terminal displayed for (B).
(E)	Sample/frame	NI Internal: OFF, 0.5, 1,2, 5, 8, 10, 20, 25, 30, 40, 50 External: OFF, Master camera Sync output rate
		GRAPHTEC External: Master camera Sync output rate * No “OFF” option provided
		YOKOGAWA Displays selectable values.
(F)	Sampling frequency	NI When “OFF” is set in the “Sample/frame”, enter a value between 1 to 9,999,999.
		GRAPHTEC Select a value from the drop-down list.
		YOKOGAWA Enter a value up to the maximum sampling frequency. The entered frequency will be converted to the higher nearest settable value.
(G)	Input method	NI Referenced Single-Ended / Non-Referenced Single-Ended / Differential
		GRAPHTEC Differential
		YOKOGAWA Differential

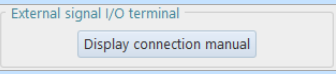
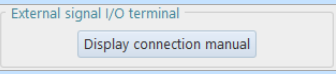
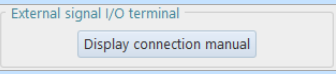

Item	Name	Function						
(H)	External signal I/O terminal	<p>A DAQ device terminal is determined by the current settings and displayed. Connect and input a “REC POS” signal of a camera to the “Stop Trigger” terminal. For details, see “10.6.1 Setting External I/O Port” on page 310.</p> <table border="1" data-bbox="440 258 1286 407"> <tr> <td data-bbox="440 258 600 297">NI</td> <td data-bbox="600 258 1286 297">Button to link to the manual appears.</td> </tr> <tr> <td data-bbox="440 297 600 336">GRAPHTEC</td> <td data-bbox="600 297 1286 336">  </td> </tr> <tr> <td data-bbox="440 336 600 407">YOKOGAWA</td> <td data-bbox="600 336 1286 407">Updates automatically as the current setting is changed (NI only).</td> </tr> </table>	NI	Button to link to the manual appears.	GRAPHTEC		YOKOGAWA	Updates automatically as the current setting is changed (NI only).
NI	Button to link to the manual appears.							
GRAPHTEC								
YOKOGAWA	Updates automatically as the current setting is changed (NI only).							
(I)	Level trigger	<p>To use the level trigger, check [Use level trigger]. Mode:</p> <ul style="list-style-type: none"> <li>Level Up: Inputs a start (or stop) trigger when the input voltage exceeds the voltage level specified from the [Level] slot at the level trigger settings while rising.</li> <li>Level Down: Inputs a trigger when the input voltage falls the voltage level specified from the [Level] slot at the level trigger settings while declining.</li> <li>Channel: Channel to which to input an analog signal as a trigger</li> </ul> <div data-bbox="467 707 1249 880" style="border: 1px solid orange; padding: 5px;"> <p> <b>NOTE</b></p> <p>When selecting a channel other than “APFIO” for [Channel] with NI DAQ, only the channel used as a trigger level can be imported and displayed as a graph.</p> </div> <ul style="list-style-type: none"> <li>Level: Voltage to determine a trigger</li> </ul> <p>For “Post trigger delay”, the timing (sampling count from the trigger input) to start and stop sampling is displayed (only for NI).</p>						
(J)	Recording and sampling duration	The recording durations of the camera and DAQ device are displayed.						
(K)	Channel	<p>Select a channel to be measured from the available channel list and make the following settings. Edit channel name: Channel name Input range: Acceptable input voltage range (only for NI)</p> <div data-bbox="467 1232 1249 1638" style="border: 1px solid orange; padding: 5px;"> <p> <b>NOTE</b></p> <ul style="list-style-type: none"> <li>When “Differential” is selected for [Input method], half of the actual channels are considered usable. Example: When there are 32 channels, channels 1 to 8 and channels 17 to 24 are displayed in the list. (Internally, there are pairs of channel 1 and channel 9, channel 2 and channel 10, ....)</li> <li>When selecting a channel other than “APFIO” for the channel used as a trigger level with NI DAQ, select the same channel.</li> <li>While being connected to a GRAPHTEC or YOKOGAWA DAQ device, the channels disabled on the DAQ device will not be enabled. Enable channels from the DAQ device beforehand.</li> </ul> </div>						
(L)	OK	Applies the settings and starts monitoring the state. This window is closed and the [DAQ State Monitoring] screen is displayed. For details of the [DAQ State Monitoring] screen, see “[DAQ State Monitoring] screen” on page 246.						
(M)	Cancel	Cancels the settings and closes this window.						

## [DAQ State Monitoring] screen

Following describes the [DAQ State Monitoring] screen.

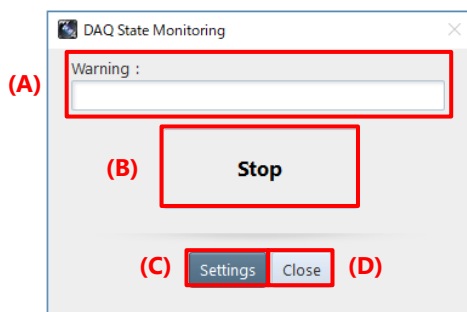

Item	Name	Function
(A)	Warning	Displays the warning that occurred due to the camera state or DAQ setting values.
(B)	Displays the state	Displays the recording status of the DAQ device. <div style="display: flex; align-items: center; margin-top: 5px;"> <div style="border: 1px solid gray; padding: 2px 5px; margin-right: 5px;">Stop</div> <span style="font-size: small;">: Live (before and after recording)</span> </div> <div style="display: flex; align-items: center; margin-top: 5px;"> <div style="background-color: orange; padding: 2px 5px; margin-right: 5px;">Now recording...</div> <span style="font-size: small;">: Recording (including endless recording)</span> </div>
(C)	Settings	Edits the DAQ device settings.
(D)	Close	Ends connection to the DAQ device.

## Displaying the imported waveform data

Waveform data recorded by using DAQ control or by using the recording function of a camera can be played back in synchronization with the shot image of the camera.

Moreover, by opening a CIH or CIHX file in FILE mode, waveform data associated with the shot image can be displayed.

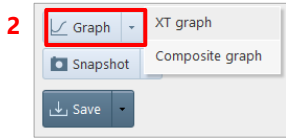

1. Select a camera from [Camera list].
2. Click [XT graph (or Composite graph)].  
When there are multiple waveform data, the [Waveform Data Select] screen is displayed.

### NOTE

- When there are multiple waveform data, you can select a waveform data type to be read.
- Up to seven formats (MCDL, waveform, Luminance, DAQ, CSV, Tracking, and ISO-MME) are displayed.

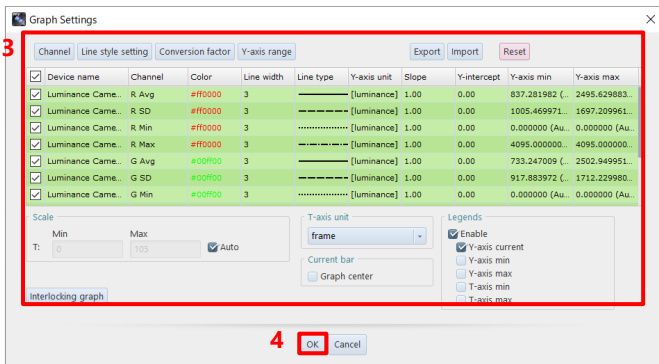
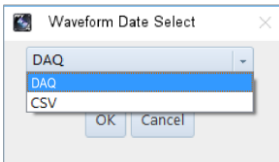

3. Make the settings.  
For details of the settings, see “[Graph Settings] screen” on page 248.
4. Click the [OK] button.

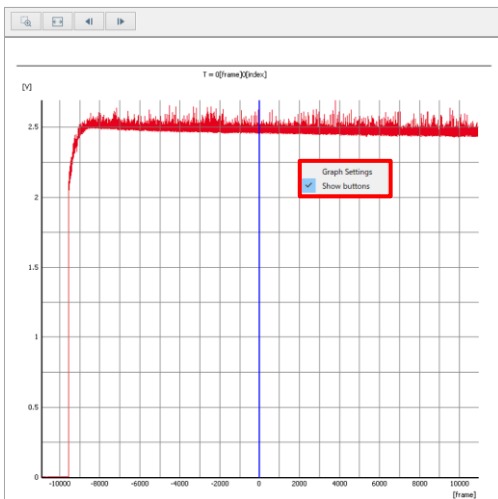

The [Graph View] screen is displayed. Clicking [Graph Settings] that appears after clicking within the graph displays the [Graph Settings] screen again. For details, see the “[Graph view] screen” on page 252.

## [Graph Settings] screen

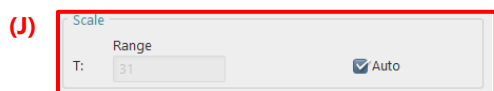
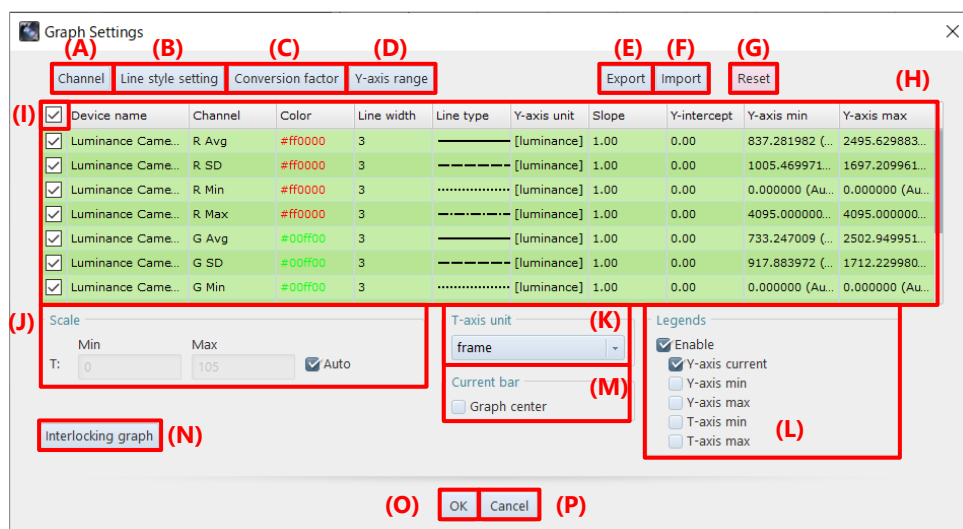

When [Graph center] of [Current bar] is checked

Item	Name	Function
(A)	Channel	The [Channel Name Settings] screen is displayed to edit the channel name. For details, see “[Channel Name Settings] screen” on page 249.
(B)	Line style setting	The [Line Style Settings] screen is displayed to edit the line style. For details, see “[Line Style Settings] screen” on page 250.
(C)	Conversion factor	The [Conversion Factor Setting] screen is displayed to edit the conversion factor. For details, see “[Conversion Factor Setting] screen” on page 250.
(D)	Y-axis range	The [Y-Axis Range Settings] screen is displayed to edit the Y-axis range. For details, see “[Y-Axis Range Settings] screen” on page 251.
(E)	Export	Displays the [Waveform Data Export] screen.
(F)	Import	Displays the [File Selection] screen. The imported CSV data will be added as the last line of the channel list.
(G)	Reset	Resets all graph settings without erasing waveform data. If you cancel after resetting, the settings will be returned to before resetting.
(H)	Channel list	Displays a list of channels whose graph is displayed and their settings.
(I)	Select channels at once	Checking this check box checks all check boxes of the channel list. Unchecking this check box unchecks all check boxes of the channel list.
(J)	Scale	Min (of the time axis): Enter the minimum value of the horizontal axis (time axis) of the graph window. Max (of the time axis): Enter the maximum value of the horizontal axis (time axis) of the graph window. Range (of the time axis): Enter the range of the horizontal axis (time axis) of the graph window. Auto: Checking this automatically adjusts the waveform data display area to the shooting data range of the camera.
(K)	T-axis unit	Specify the unit of the horizontal axis (time axis). Select from among frame/sec/msec/μsec/Custom.

Item	Name	Function
(L)	Legends	Enable: Checking/unchecking this check box toggles to show or hide all items in [Legends]. Y-axis current, Y-axis min, Y-axis max, T-axis min, T-axis max: Checking/unchecking each check box toggles to show or hide the corresponding option.
(M)	Graph center	Checking this check box always displays the current bar at the center of a graph.
(N)	Interlocking graph	Changes the current XT graph settings to a composite graph setting.
(O)	OK	Applies the settings and closes this screen.
(P)	Cancel	Closes the screen without applying the changed settings.

### [Channel Name Settings] screen

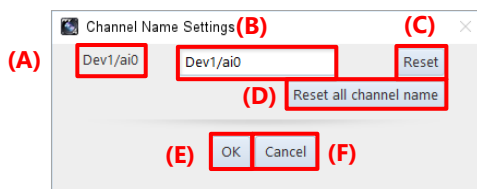

Item	Name	Function
(A)	Original channel name	Displays the original channel name.
(B)	New channel name	Enter a desired channel name.
(C)	Reset	Resets the changed channel name to its original name.
(D)	Reset all channel name	Resets all channel names to their original names.
(E)	OK	Applies the settings and closes this screen.
(F)	Cancel	Closes the screen without applying the changed settings.

## [Line Style Settings] screen

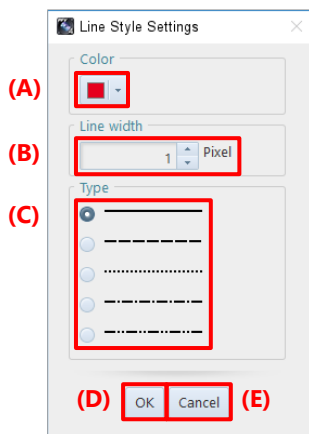

Item	Name	Function
(A)	Color	Select a line color from the list to be displayed by clicking.
(B)	Line width	Specify the line width. The specifiable range is 1 to 100.
(C)	Type	Select a line type. Select from “solid line”, “dashed line”, “dotted line”, “dashed-dotted line” and “dashed-two dotted line”.
(D)	OK	Applies the settings and closes this screen.
(E)	Cancel	Closes the screen without applying the changed settings.

## [Conversion Factor Setting] screen

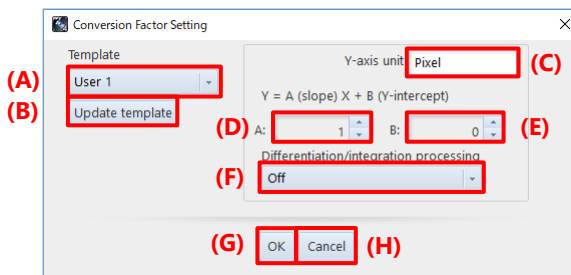

Item	Name	Function
(A)	Template	Select the conversion factor template that has been registered.
(B)	Update template	Registers the entered values as a template.
(C)	Y-axis unit	Edit the Y-axis unit.
(D)	Slope	Enter the slope value. The specifiable range is -99999 to 99999.
(E)	Y-intercept	Enter the Y-intercept value. The specifiable range is -99999 to 99999.
(F)	Differentiation/integration processing	Select from among Off/Time integration (acceleration to speed)/Dual time integration (acceleration to displacement).
(G)	OK	Applies the settings and closes this screen.
(H)	Cancel	Closes the screen without applying the changed settings.

## [Y-Axis Range Settings] screen

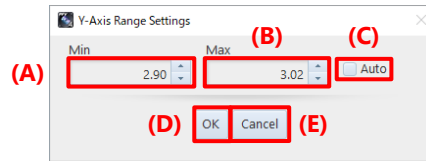

Item	Name	Function
(A)	Min	Enter the minimum value of the Y-axis.
(B)	Max	Enter the maximum value of the Y-axis.
(C)	Auto	Checking this automatically adjusts the Y-axis display area to the Y value range of the currently imported waveform data.
(D)	OK	Applies the settings and closes this screen.
(E)	Cancel	Closes the screen without applying the changed settings.

## [Graph view] screen

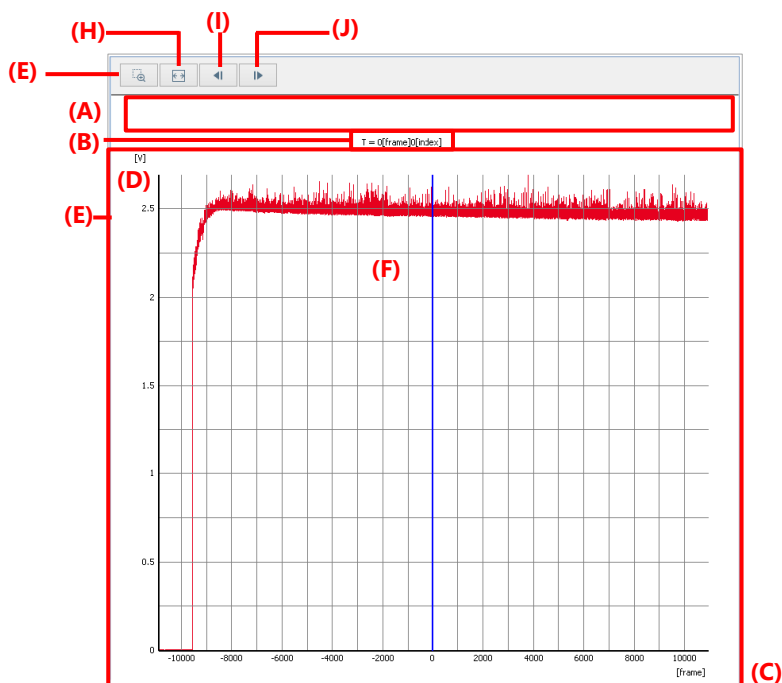

Item	Name	Function
(A)	Legend	Displays detailed information of the selected channel's graph.
(B)	Current T-axis value	Displays the current position of the time axis.
(C)	T-axis scale	Displays the scale of the time axis.
(D)	Y-axis scale	Displays the scale of the Y-axis.
(E)	Graph	Displays a graph of each channel. Right-click this area displays the menu including [Graph Settings] and [Export Data]. Selecting [Graph Settings] displays the [Graph Settings] screen. Selecting [Export Data] displays the [Waveform Data Export] screen. For details of the [Waveform Data Export] screen, see "[Waveform Data Export] screen" on page 254.
(F)	Current bar	Displays the current position. When playing back a video, the current bar moves in conjunction. When moving the current bar, the relevant frame of a video will be played back in conjunction.
(G)	Enlarge	Click the button to enable its function and drag a desired area. Then the selected area will be enlarged.
(H)	Fit	Clicking this button puts a graph within a graph window.
(I)	Sampling Back	Returns the T-axis in sampling unit and updates the window. Clicking this button while playing back a video stops the playback.
(J)	Sampling Forward	Proceeds the T-axis in sampling unit and updates the window. Clicking this button while playing back a video stops the playback.



## Saving waveform data

Waveform data is saved in a CIHX file automatically by saving the associated image. By opening the saved image, a graph is also displayed. Waveform data can be saved in a CSV file or TEMA format separately from an image. The procedure is described below.

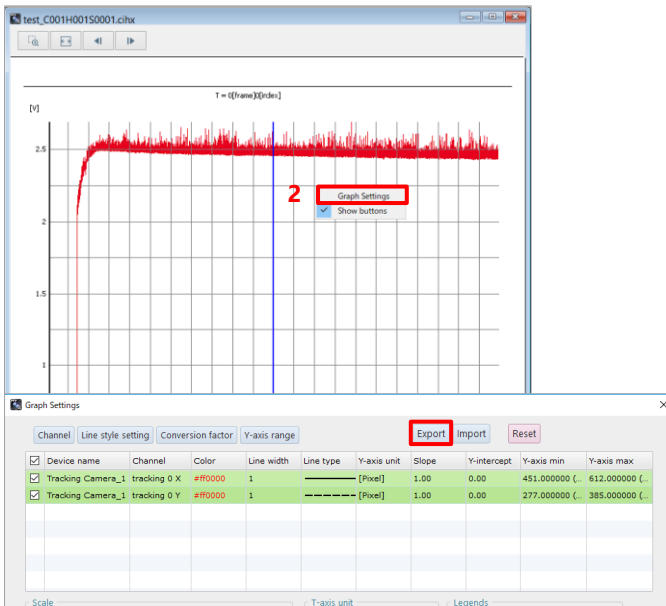

1. Display the waveform data graph to be saved.
2. Right-click on the graph, click “Graph Settings” and the [Export] button in the “Graph Settings” dialog.

3. Make the settings.  
For details of the settings, see “[Waveform Data Export] screen” on page 254.

4. Click the [Export] button.

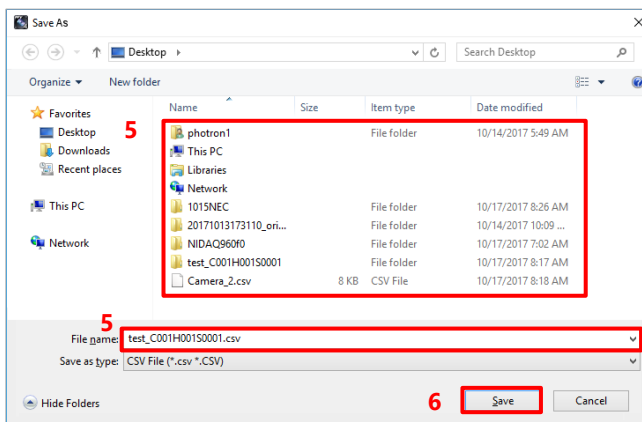

5. Select the folder in which to save the waveform data graph and the filename.

6. Click the [Save] button.  
Then, the waveform data will be downloaded.

### NOTE

Waveform data can be saved in CSV format when saving an image.

On the image save settings screen, check “Save waveform data in CSV format” and select the saving format. Then waveform data will be saved in a CSV file when saving the associated image.

## [Waveform Data Export] screen

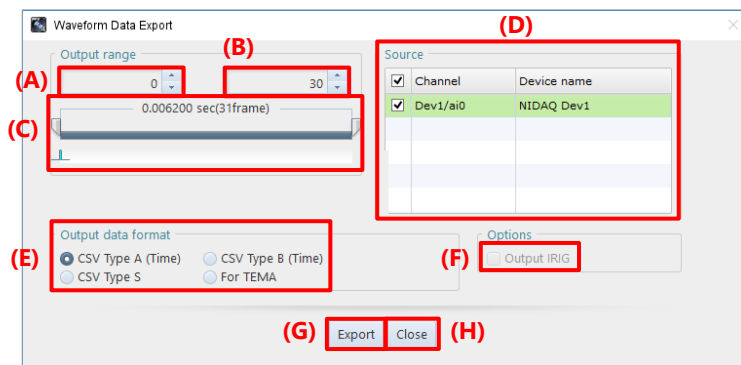

Item	Name	Function
(A)	Lower limit of the output range	Set the lower limit of the output range.
(B)	Upper limit of the output range	Set the upper limit of the output range.
(C)	Output range slider	Set the output range by dragging the slicer.
(D)	Source	Check the channel to be output.
(E)	Output data format	Select the output data format.
(F)	Output IRIG	Check this to output IRIG. This option can be selected when the output data format is “CSV TypeA (Time)” or “CSV TypeB (Time)”.
(G)	Export	Click to export the waveform data in a CSV file. The file save dialog is displayed. Click the [Save] button.
(H)	Close	Closes the screen without applying the changed settings.

## Associating waveform data

The method to associate waveform data is described below.

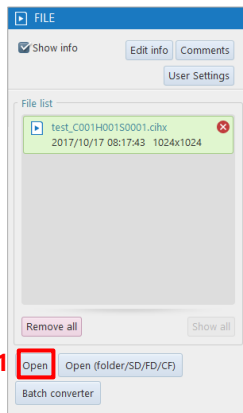

1. Click the [Open] button in FILE mode.
2. Select the target CSV file and click the [Open] button.  
For the corresponding waveform data, the [CSV Import] screen is displayed.

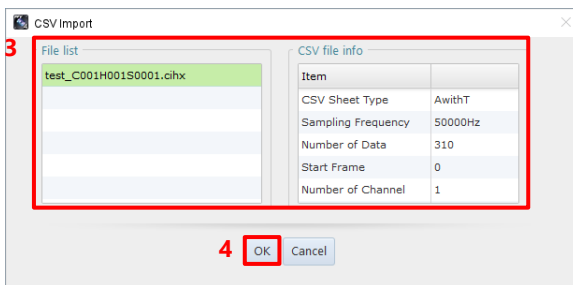

3. Select a file with which to associate waveform data.  
For details of the settings, see “[CSV Import] screen” on page 255.
4. Click the [OK] button.  
The waveform data is imported and the [Graph Settings] screen is displayed.

## [CSV Import] screen

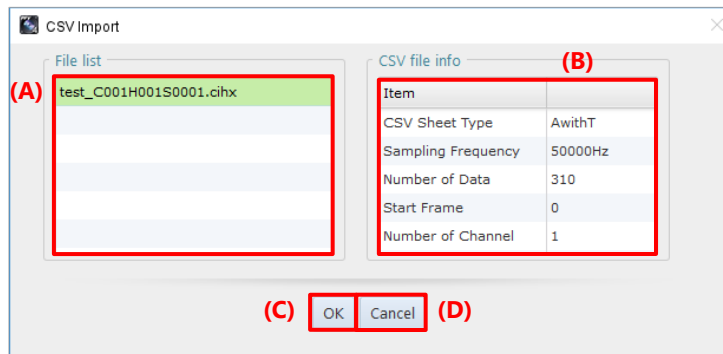

Item	Name	Function
(A)	File list	Select a file to combine.
(B)	CSV file info	Displays the header information of the CSV file.
(C)	OK	Imports the CSV file.
(D)	Cancel	Closes the screen without applying the changed settings.

**[Composite Graph Settings] screen**

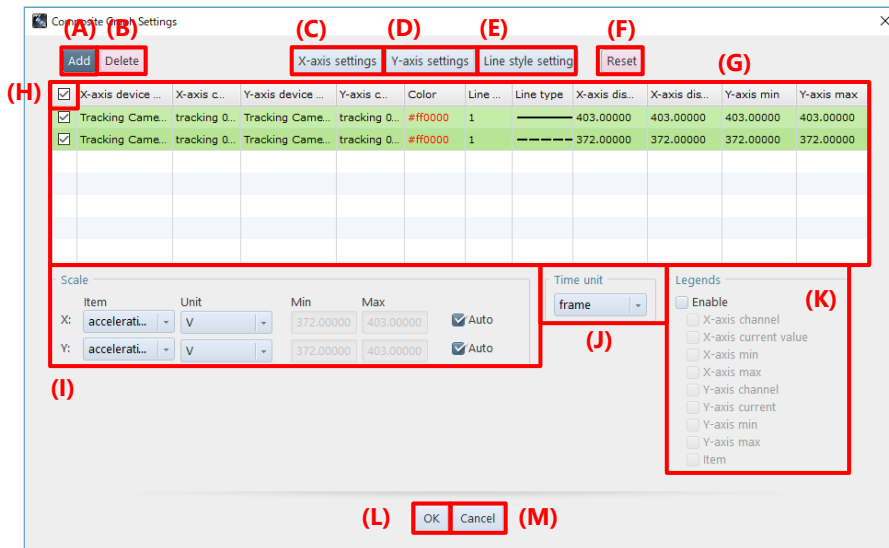

Item	Name	Function
(A)	Add	Click here to add the same information as the graph of the first line to the last line. This button is disabled with a composite graph which is called by clicking the [Interlocking graph] button from the XT graph settings dialog.
(B)	Delete	Click here to delete lines whose boxes are checked. This button is disabled with a composite graph which is called by clicking the [Interlocking graph] button from the XT graph settings dialog.
(C)	X-axis settings	Click here to show the [X axis settings] screen. See the [X axis settings] screen for details.
(D)	Y-axis settings	Click here to show the [Y axis settings] screen. See the [Y axis settings] screen for details.
(E)	Line style settings	The [Line Style Settings] screen is displayed to edit the line style. For details, see “[Line Style Settings] screen” on page 250.
(F)	Reset	Resets all graph settings without erasing waveform data. If you cancel after resetting, the settings will be returned to before resetting.
(G)	Channel list	This is the channel list showing their setting information for graph. Setting status of the relevant channels will also be changed with a composite graph which is called by clicking the [Interlocking graph] button from the XT graph settings dialog or when selected channels are changed in the XT graph.
(H)	Select channels at once	Put a check here to put a check to all the channels in the channel list. Uncheck to remove the checks from all the channels in the channel list.
(I)	Scale	Item: Displays the list of items set from the X/Y-axis settings. Unit: Displays the list of units of the axis set from the X/Y-axis settings. Min: Can be set when "Auto" for X/Y-axis is unchecked. Max: Can be set when "Auto" for X/Y-axis is unchecked.
(J)	Time unit	Sets the time unit. Select from among frame/sec/msec/μsec/Custom.

Item	Name	Function
(K)	Legends	Enable: Switches between display/hide each legend by checking/unchecking the box. X/Y-axis channel, X/Y-axis current value, X/Y-axis min, X/Y-axis max and Item: Switches between display/hide the items for each channel by checking/unchecking the box.
(L)	OK	Applies the settings and closes this screen.
(M)	Cancel	Closes the screen without applying the changed settings.

## [X/Y-axis settings] screen

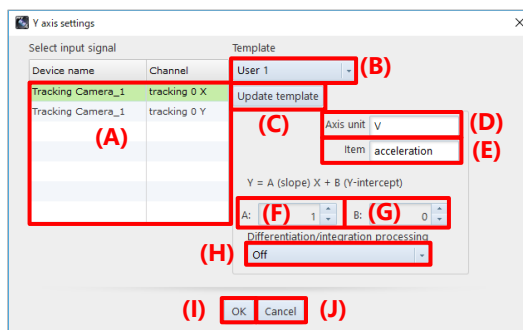
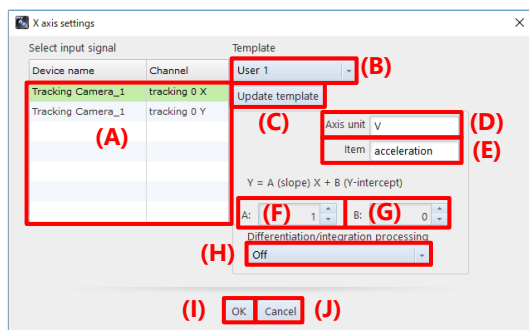

Item	Name	Function
(A)	Select input signal	Click and select the data source. This feature is disabled with a composite graph which is called by clicking the [Interlocking graph] button from the XT graph settings dialog.
(B)	Template	Select a conversion factor template which is registered beforehand. Select from among User 1 to 4 that includes the axis unit, item name and input value of Y-intercept.
(C)	Update template	Registers the axis unit, item name and the input value of Y-intercept to the template.
(D)	Axis unit	Edit axis unit here. If the [Update template] button is clicked after entering the value, the data is registered to the selected template.
(E)	Item	Edit item name here. If the [Update template] button is clicked after entering the value, the data is registered to the selected template.
(F)	Slope	Enter value of slope. The values between -99999 and 99999 can be entered.
(G)	Y-intercept	Enter value of Y-intercept. The values between -99999 and 99999 can be entered.
(H)	Differentiation/ integration processing	Select from options: Off/Time integration (acceleration to speed)/Dual time integration (acceleration to displacement).
(I)	OK	Applies the settings and closes this screen.
(J)	Cancel	Closes the screen without applying the changed settings.

## 8.7.2. PFV4 Mobile

This is a feature to remotely adjust the angle of view by establishing a server with the PC which controls the camera and accessing from iPad to display the LIVE screen.

This is available only in LIVE mode, and it behaves regarding PFV4 as the server, and the mobile device as the client. There are two ways to connect it; scan a QR code and connect from the communication settings.

### ■ Mobile device specifications (※Operation is verified on iPad Air 2, iPad Pro)

- OS: iOS 13.3.1 or later
- Web browser: Safari (necessary)
- Resolution: 1,536 x 2,048 or more
- Display size: 9.7 inch or more recommended,

A use in landscape orientation with “Rotation Lock” is recommended.

### NOTE

- Connect the PC which is connected to the camera to the local network.  
However the communication speed is lowered if the network is same as camera's.
- Connect PC and the mobile device to an identical wireless network.
- To use PFV4 Mobile, make sure that add the shortcut to home screen and reconnect from the shortcut.

The setup procedure is described below.



1. Click the [Add-ons] – [PFV4 Mobile].

2. Select the IP address in the same network range as your iPad from the list.

3. Click the [Start Server] button in the [QR code] tab.

QR code appears under the [IP address] in the [QR code] tab.

To check and configure the communication settings, switch to the [Communication settings] tab.

### NOTE

If necessary, modify the settings in the [Communication settings] tab.



4. Scan the QR code.

If the QR code cannot be scanned correctly, access the URL shown under the QR code via Safari.

**NOTE**

- With the default setting, the port 80 and 443 are used.
- When the behavior is felt slow, it can be improved by adjusting “Skip” and “Quality”.

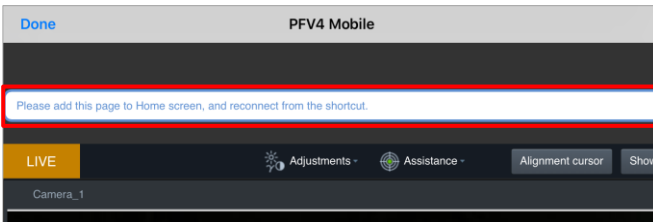

5. Open PFV4 Mobile in Safari.

“Please add this page to Home screen and reconnect from the shortcut.” appears.

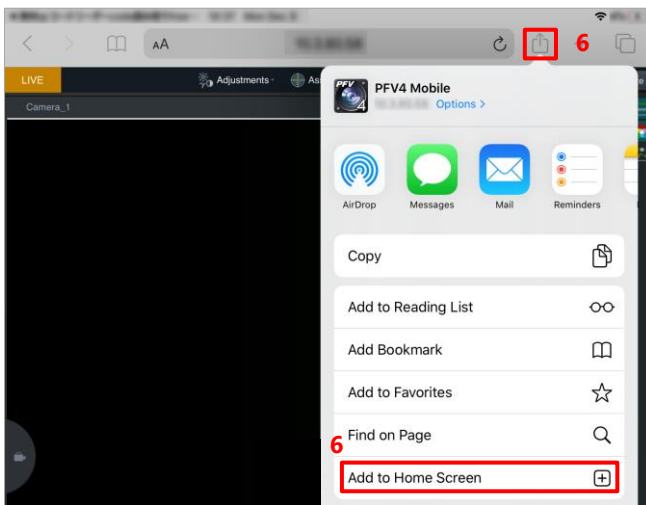

6. Tap the [Share] button and tap the [Add to Home Screen] to create the shortcut.

7. Tap the shortcut icon to reconnect to the PFV4 Mobile.

Following describes the [PFV4 Mobile] screen.

**[PFV4 Mobile] screen**

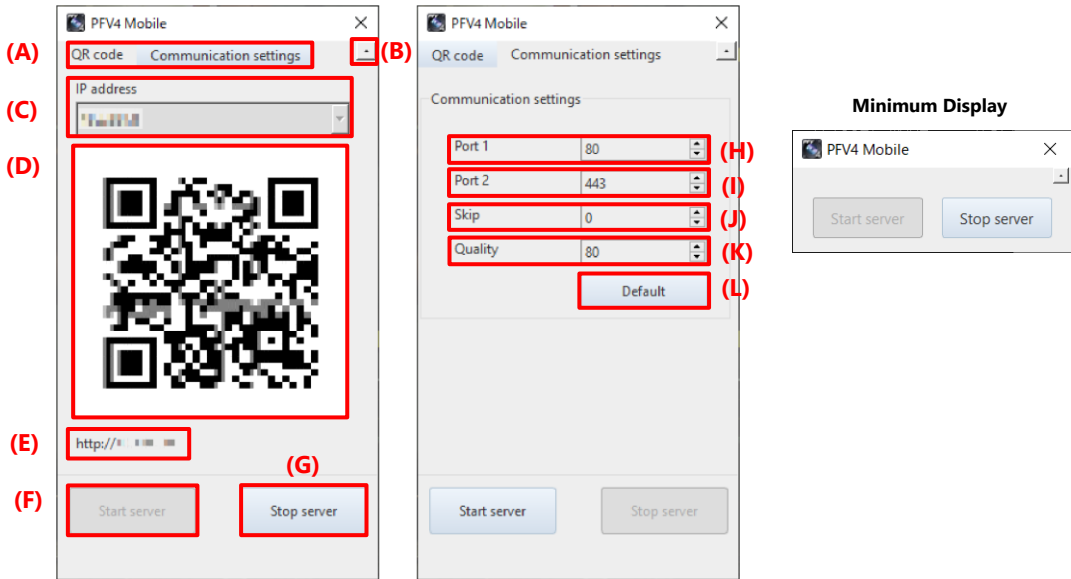

Item	Name	Function
(A)	Display switching tab	Switches between “QR code” and “Communication settings” and configure the settings.
(B)	Maximum/Minimum display	Switches to the maximum or minimum screen display.
(C)	IP Address list	Shows the IP address of the PC.
(D)	QR code	Shows the QR code to access the server.
(E)	URL text	Shows the URL to access the server.
(F)	Start server	Click the button to startup the server.
(G)	Stop server	Click the button to stop the server during startup.
(H)	Port 1	Configure the port number for http communication.
(I)	Port 2	Configure the port number for WebSocket communication.
(J)	Skip	When this value is 0, an image is transmitted for every image updating, and when it is 1, an image is transmitted for every two updates of image.
(K)	Quality	Specify the image compression quality. Enter a larger value for a higher quality.
(L)	Default	Click the button to return the settings to the default.



## Client display

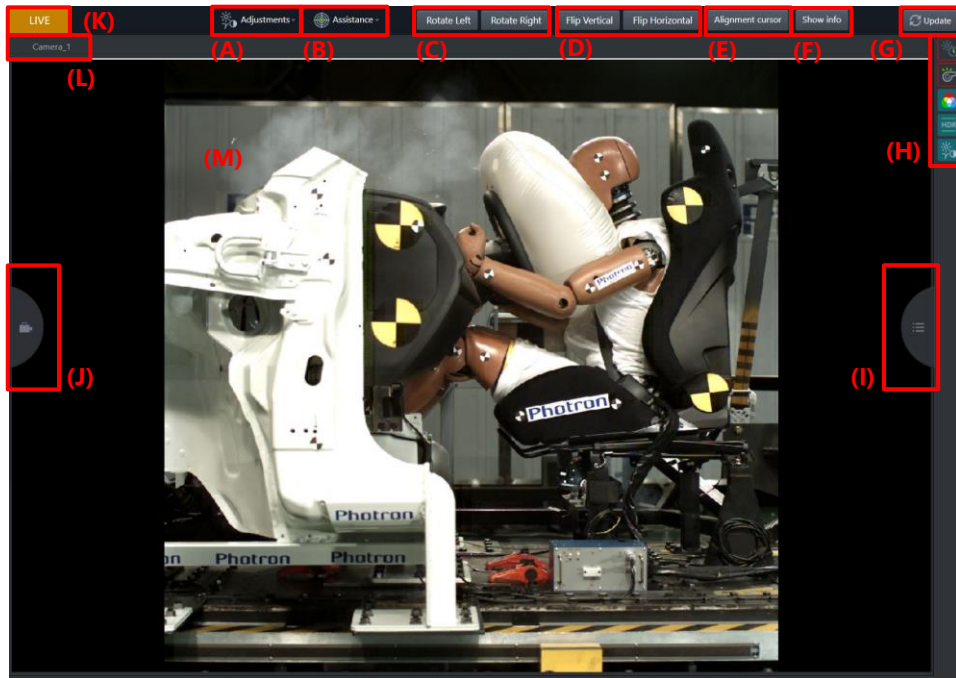

Item	Name	Function
(A)	Adjustments menu	Tap to show the image quality adjustment menu list.
(B)	Assistance menu	Tap to show the shooting assistance menu list.
(C)	Rotate Left / Right	Rotate the image left or right.
(D)	Flip Vertical / Horizontal	Flip the image vertically or horizontally.
(E)	Alignment cursor	Switches displaying and hiding the center line. The setting of alignment cursor is not applied to the server side.
(F)	Show info	Switches displaying and hiding the shooting information.
(G)	Update	Tap to update the browser.
(H)	Effect bar	Displays the icons of applied effects.
(I)	Side panel (Right)	Switches displaying and hiding the side panel (Right). For details, see the “Side panel (Right)” on page 262.
(J)	Side panel (Left)	Switches displaying and hiding the side panel (Left). For details, see the “Side panel (Left)” on page 263.
(K)	Canvas	The area to display an image created by PFV. Pinch/pinch out on the canvas to zoom / zoom out the image. Swipe to switch the camera.
(L)	Camera name panel	Displays the camera name of the selected device.
(M)	Live panel	Goes gray when the server is in other than LIVE mode. Tap it to put the server in LIVE mode.

### NOTE

If the camera is locked in [Add-ons] - [MCAT], the settings from PFV Mobile will also be locked. Unlock the setting on MCAT before configuring settings.



## CAUTION

The warning “There was a sudden temperature change in the camera head or relay box. Reset the camera communication from PFV4.” is displayed when there is a sudden temperature change in the camera head or relay box. The operation from the client side will be temporarily stopped. Reset the camera communication from PFV4. For details, see “Q10. A confirmation message for the camera communication reset while using ST Camera Head.” of “FAQ and Troubleshooting”, on page 325.

### Side panel (Right)

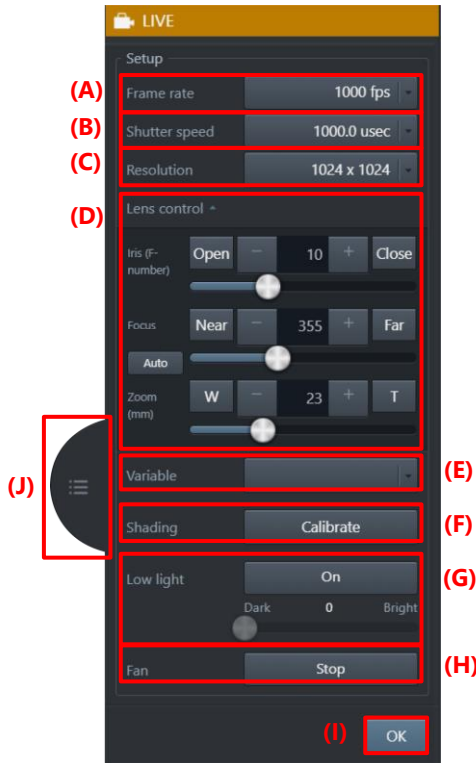

Item	Name	Function
(A)	Frame rate	The value is linked with the contents on the server. When the setting is variable, it only shows “Variable” and the frame rate is shown on the server only.
(B)	Shutter speed	The value is linked with the contents on the server. Set enabling or disabling the shutter lock from the server.
(C)	Resolution	The value is linked with the contents on the server. When the setting is variable, it only shows “Variable”. Configure settings other than resolution (e.g., resolution lock) from the server.
(D)	Lens control	Change the setting value by moving the slider or by other touch operation on the iPad.
(E)	Variable	The variable setting registered from the server can be switched. Register the setting from the server.
(F)	Shading	Notifies starting shading calibration to the server and starts shading calibration.
(G)	Low light	Notifies starting low light mode to the server and moves to low light mode.
(H)	Fan	Notifies stopping fan to the server and stops fan.
(I)	OK	Tap to close the side panel.
(J)	Open/close panel	Tap to open/close the side panel (Left).

## Side panel (Left)

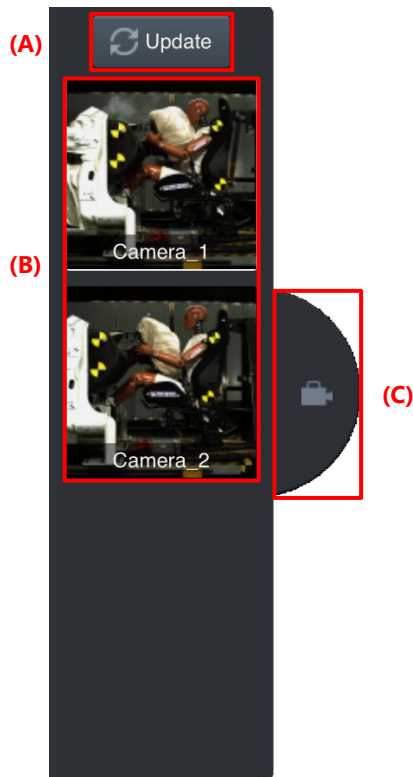

Item	Name	Function
(A)	Update	Tap to update the connected devices and thumbnail images.
(B)	Camera list	Shows device names and thumbnails. The device which displays the currently shown image is enclosed in a white frame. Tap the displayed thumbnail to switch the camera. PFV Mobile updates thumbnail images in following cases: <ul style="list-style-type: none"> <li>• when accessing to PFV</li> <li>• when the [Update] button is tapped</li> </ul>
(C)	Open/close panel	Tap to open/close the side panel (Left).

### 8.7.3. MCAT

This function is used to control multiple high-speed cameras. The MCAT window displays a list of connection status and setting values of multiple cameras, and a lock function for each camera reduces setting errors and improves work efficiency. It is also possible to save settings to multiple SSDs in parallel to speed up the saving process. While MCAT is running, the function panel and part of the control panel are disabled, and settings and recording operations are performed from the MCAT window.

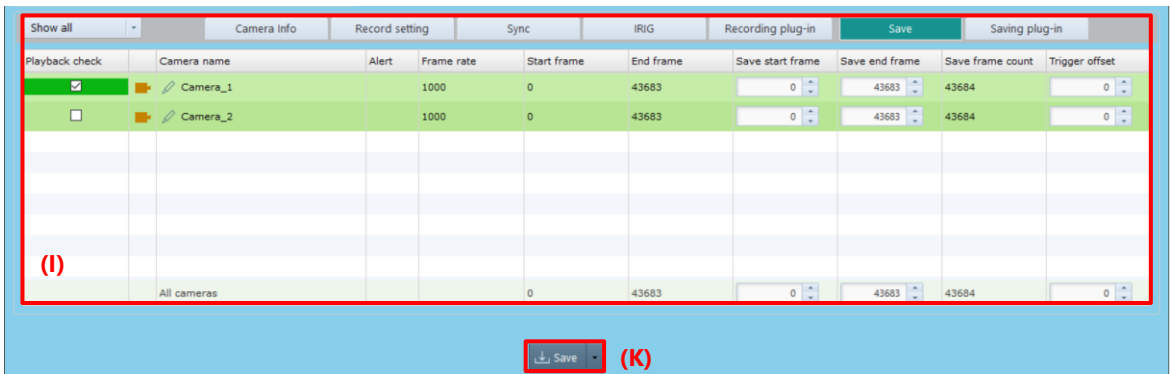
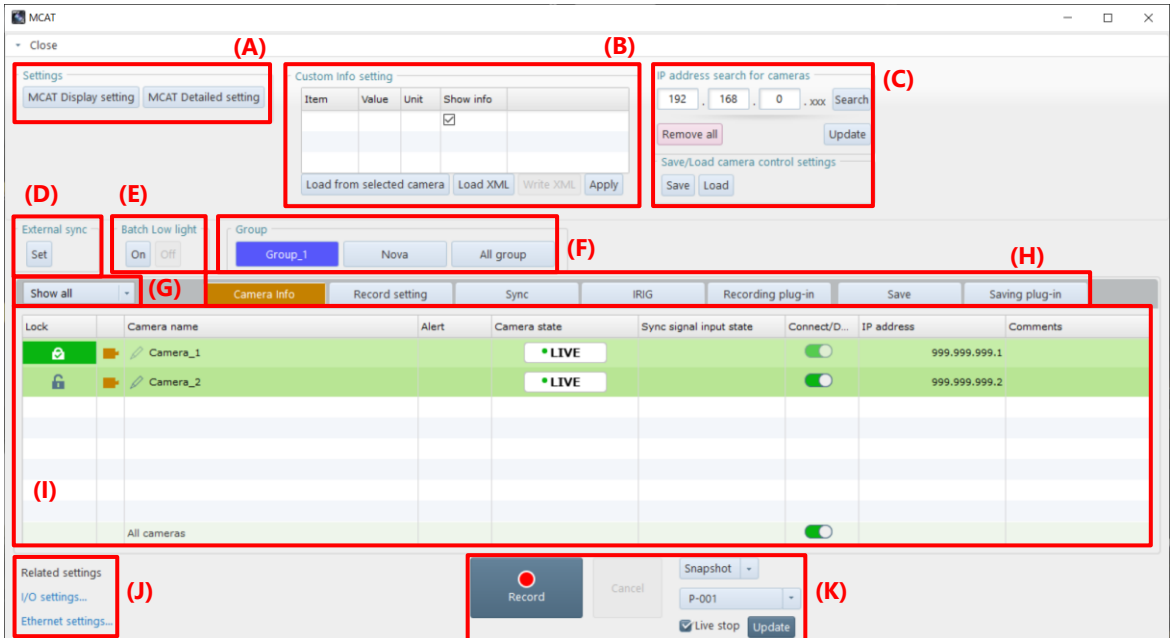

Item	Name	Function
(A)	Settings	MCAT Display setting: Click this to set whether to show or hide items on the MCAT window. For details, see “MCAT Display setting”. MCAT Detailed setting: Click this to set detailed setting. For details, see “MCAT Detailed setting”.
(B)	External sync	Connect to a signal generator or signal distributor and select the synchronization signal frequency. For setting details, see “8.5.1 Camera Synchronization Settings” on page 204.
(C)	Custom info setting	Displays custom information for the selected camera. For details, see “[User Settings] screen” on page 46.

Item	Name	Function
(D)	IP address search for cameras	Searchs for cameras by IP address. Operation is the same as in the [Camera Controls] panel. For details, see “4.2 Camera Controls Menu” on page 50.
(E)	Batch Low light	Click [On] to put all unlocked cameras on the MCAT table into low light mode. Clicking [Off] will deactivate low light mode.
(F)	Group	Switches the table display to group units.
(G)	Filter	Select the camera status to be displayed from the drop-down list.
(H)	Tabs	Switches the display of the MCAT table. [LIVE] mode related: Camera Info, Record setting, Sync, IRIG, Recording plug-in [MEMORY] mode related: Save, Saving plug-in
(I)	MCAT table	Displays the setting information and various settings can be configured for each camera, and the display switches according to the tab selected. You can customize the position of items by dragging and dropping them. To return to the initial order, click [MCAT Detailed settings] - [Other settings] and click the [Reset] button under “Order of MCAT Table Items”. All cameras can be configured at once by making each setting in “All Cameras”.
(J)	Related settings	Click [I/O settings] to display I/O settings window. For details, see “10.6 I/O Settings” on page 308. Click [Ethernet settings] to display Ethernet settings window. For details, see “10.1.2 [Ethernet settings] Screen” on page 297.
(K)	Recording/playback panel	Displays buttons and setting items related to image playback and saving. The items displayed switch depending on the mode and the tab clicked on (G). Not available when there is no view window in the image display area. Check [Live stop] displayed in recording related tabs to stop the live image update.

## NOTE

- If the camera is locked in [Add-ons] - [MCAT], the settings from PFV Mobile will also be locked. Unlock the setting on MCAT before configuring settings.
- The MCAT table changes the background color of the window depending on the recording condition.

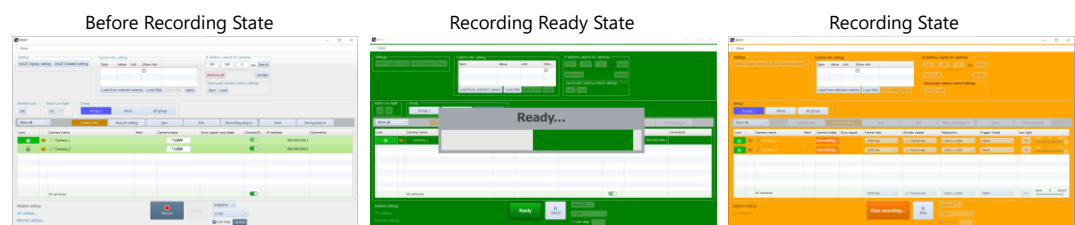

## MCAT Display setting

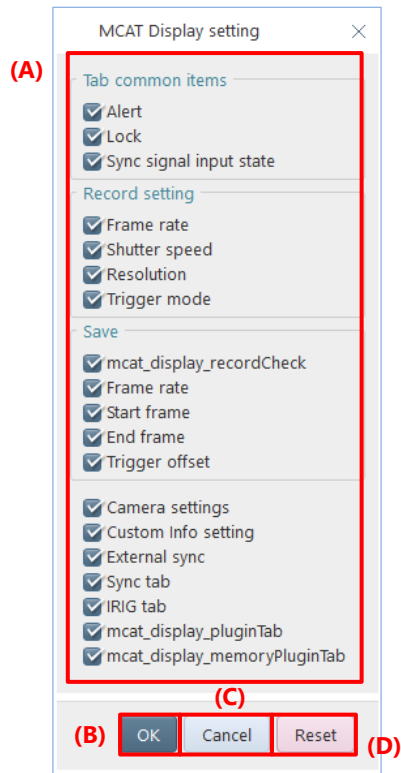

Item	Name	Function
(A)	Display item	Check the box to show or hide the item.
(B)	OK	Applies the settings and closes this screen.
(C)	Cancel	Closes the screen without applying the changed settings.
(D)	Reset	Returns the settings to default.

## MCAT Detailed setting

### ■ Group settings

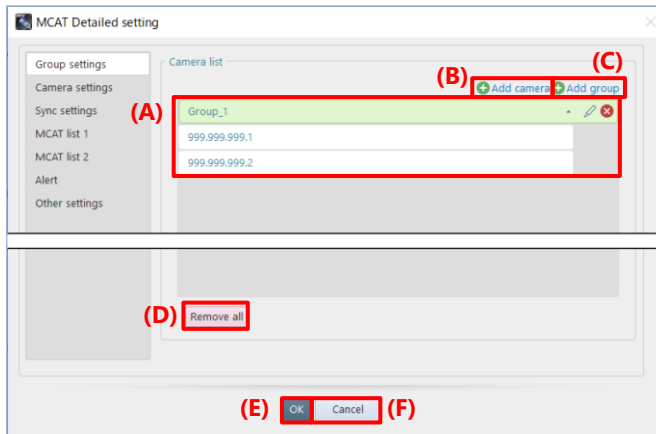

Item	Name	Function
(A)	Camera list	Displays the list of groups and cameras.
(B)	Add camera	Adds a camera to the camera list.
(C)	Add group	Adds a group to the camera list.
(D)	Remove all	Removes all group and camera from the camera list.
(E)	OK	Applies the settings and closes this screen.
(F)	Cancel	Closes the screen without applying the changed settings.

## How to add group

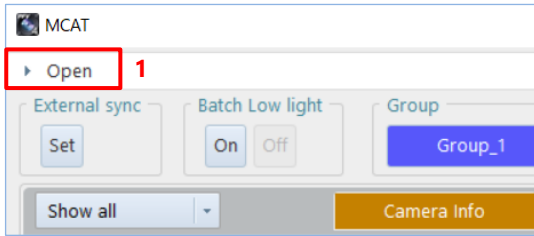

1. Click [Open] in the upper left corner of MCAT window.

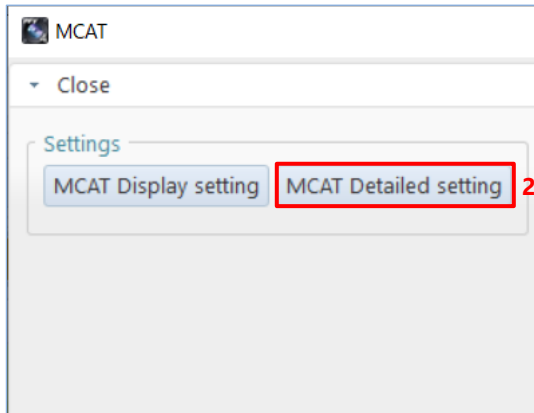

2. Click [MCAT Detailed setting] button under “Settings”.

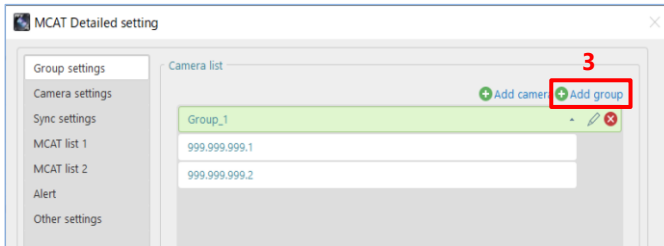

3. Click [Add group] button.

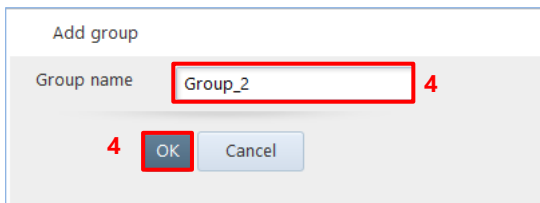

4. Enter group name and click [OK] button.



## How to change group name

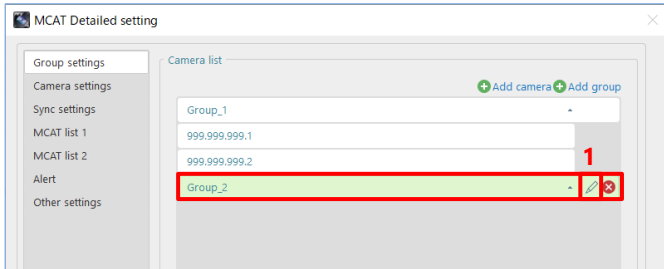

1. Select the group you want to edit and click the [Edit] icon.

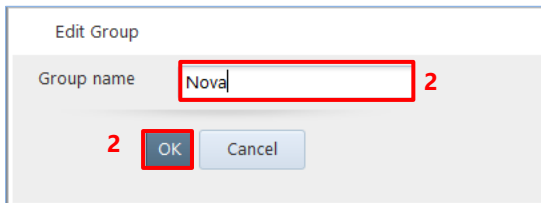

2. Change group name and click [OK] button.

## How to remove group

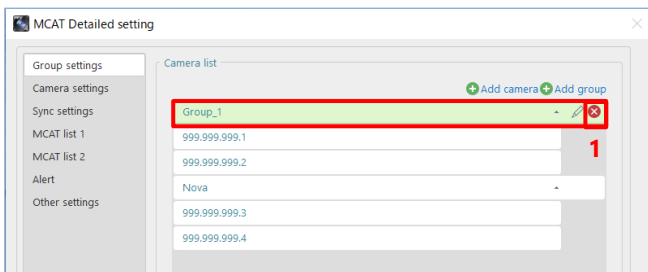

1. Select the group you want to remove and click the [Remove] icon.

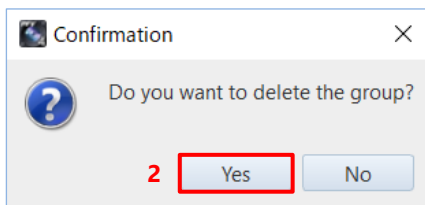

2. The confirmation message appears. Click [Yes] button.

## How to add camera

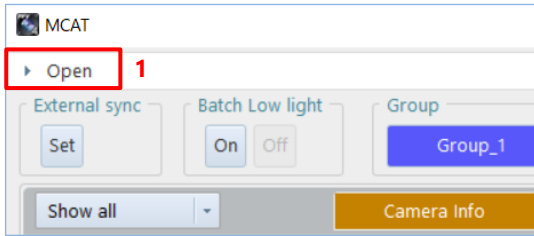

1. Click [Open] in the upper left corner of MCAT window.

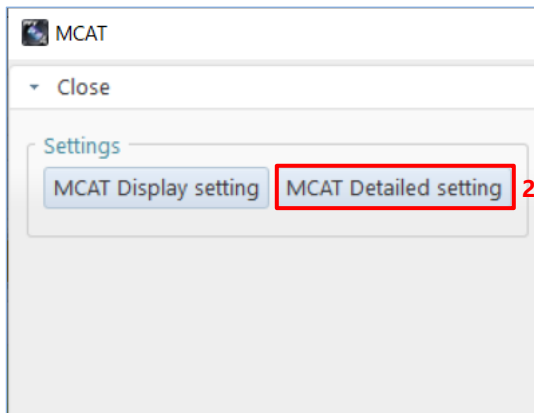

2. Click [MCAT Detailed setting] button under “Settings”.

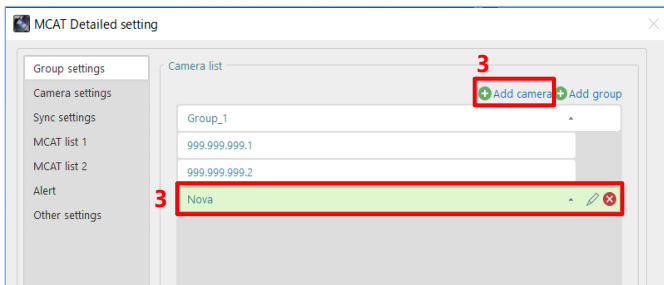

3. Select the group to which you want to add a camera. Click [Add camera] button.

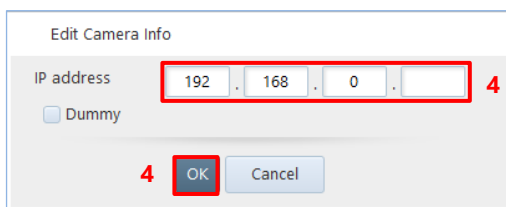

4. Edit the camera IP address and click [OK] button.

## How to change camera IP address



1. Select the camera you want to edit and click the [Edit] icon.

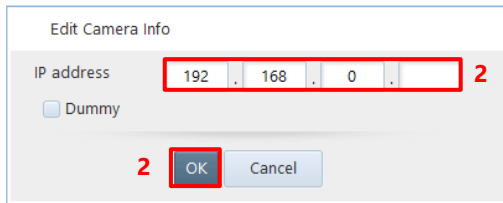

2. Change the IP address and click [OK] button.

## How to remove camera

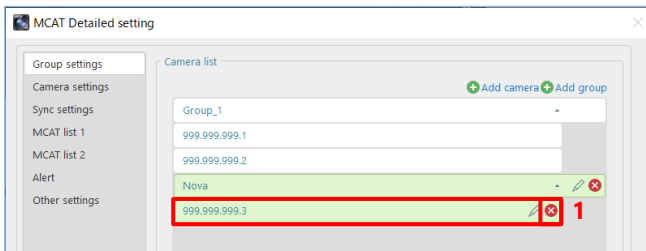

1. Select the camera you want to remove and click the [Remove] icon.

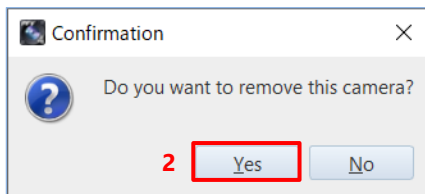

2. The confirmation message appears. Click [Yes] button.

## ■ Camera settings

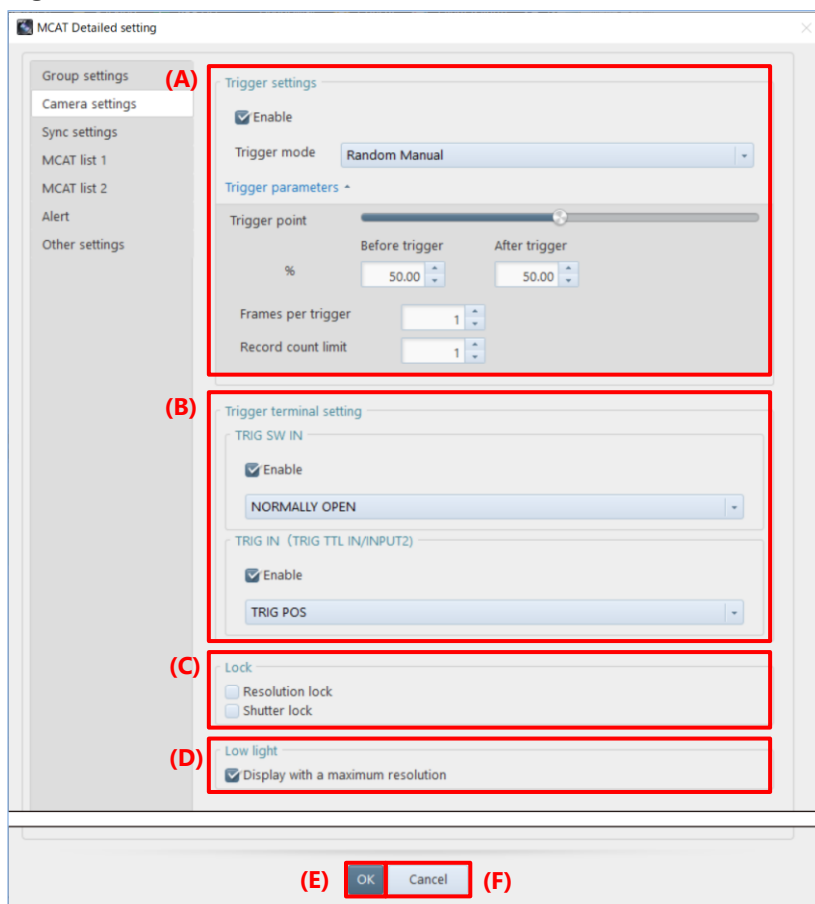

Item	Name	Function
(A)	Trigger settings	<p>If “Enable” is checked, the trigger settings for the cameras on the MCAT table are set to the trigger settings configured below.</p> <p>In addition, the trigger settings for the cameras on the MCAT table can be changed at once by changing the following trigger settings. For details about the trigger setting, see “4.4.3 Trigger Mode Types” on page 80.</p> <ul style="list-style-type: none"> <li>• Trigger point: Set the percentage of frames recorded before and after the trigger by using the slider or entering a numerical value.</li> <li>• Frames per trigger: Set the number of frames to be recorded per trigger input.</li> <li>• Record count limit: Set the maximum number of triggers to apply.</li> </ul>
(B)	Trigger terminal setting	<ul style="list-style-type: none"> <li>• TRIG SW IN : Check “Enable” when using TRIG SW IN. Select the terminal type from the drop-down list.</li> <li>• TRIG IN (TRIG TTL IN / INPUT2): Check “Enable” when using TRIG IN. Select the terminal type from the drop-down list.</li> </ul>
(C)	Lock	<p>Resolution lock: The resolution is maintained without automatic change even if the frame rate is changed. For details, see “4.3.3 Resolution Lock” on page 67.</p> <p>Shutter lock: The shutter speed is maintained without automatic change even if the frame rate is changed. For details, see “4.3.4 Detailed Settings of Shutter Speed” on page 68.</p>
(D)	Low light	Check “Display with a maximum resolution” to display live image at the maximum resolution of camera during the low light mode.

Item	Name	Function
(E)	OK	Applies the settings and closes this screen.
(F)	Cancel	Closes the screen without applying the changed settings.

## ■ Sync settings

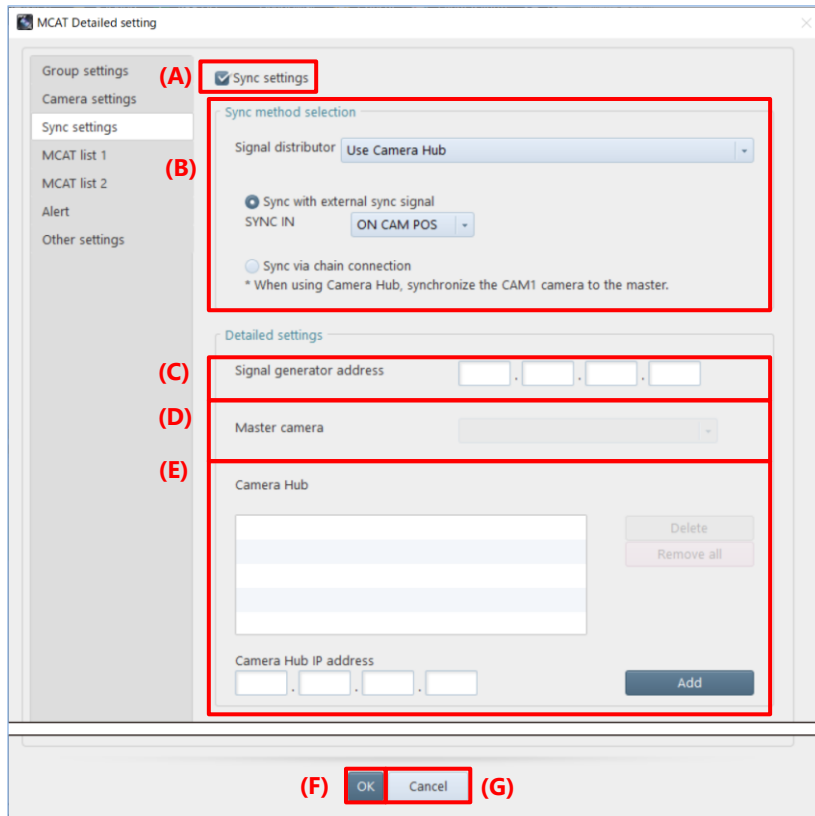

Item	Name	Function
(A)	Sync settings	Check “Sync settings” when performing sync recording.
(B)	Sync method selection	Signal distributor: Select the type of signal distributor. Sync with external sync signal: Check this and set when the synchronization signal is input externally. Sync via chain connection: Check this to use the camera connected to the CAM1 connector as master for synchronization.
(C)	Signal generator address	Enter the address of the signal generator to be connected.
(D)	Master camera	Select the camera to be the master from the list of cameras displayed in the list.
(E)	Camera Hub	To specify the Camera Hub, enter the address of the Camera Hub to be connected and click [Add]. To remove, select the Camera Hub to be removed and click [Delete] button or click [Remove all] button.
(F)	OK	Applies the settings and closes this screen.
(G)	Cancel	Closes the screen without applying the changed settings.



## NOTE

For details, see “8.5.1 Camera Synchronization Settings” on page 204.

### ■ MCAT list 1

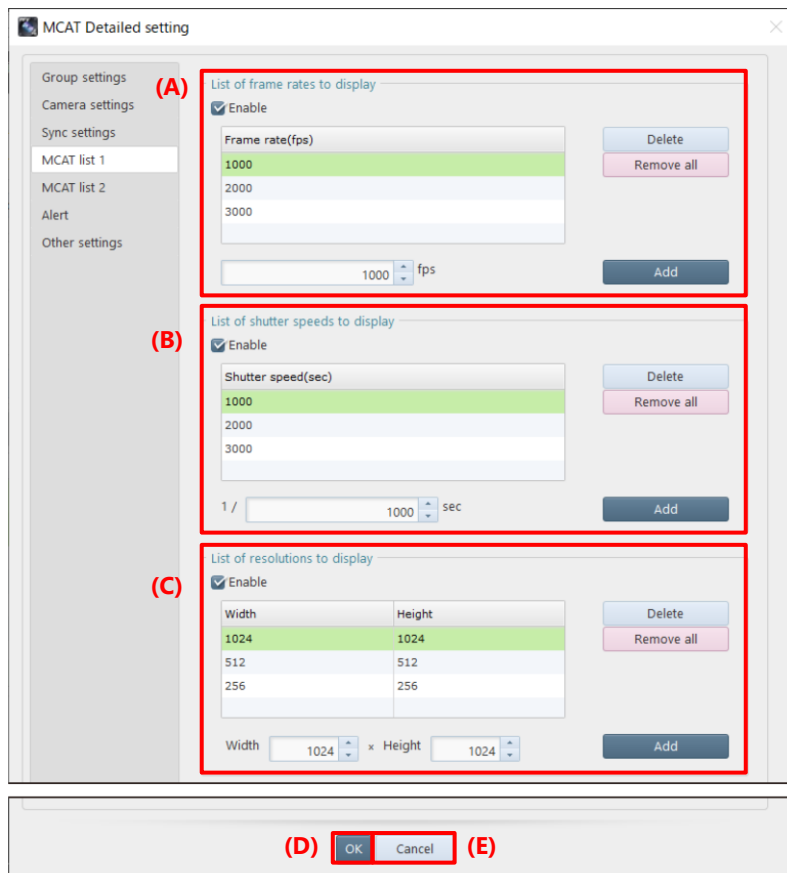

Item	Name	Function
(A)	List of frame rates to display	Check “Enable” if you want MCAT to display the frame rate edited here. Edit the list of frame rates that can be selected on MCAT. To add, enter the frame rate and click [Add] button. Min. value “1” to max. value “99,999,999” can be set. To remove, select the frame rate and click [Delete] button or click [Remove all] button.
(B)	List of shutter speeds to display	Check “Enable” if you want MCAT to display the shutter speed edited here. Edit the list of shutter speeds that can be selected on MCAT. To add, enter the shutter speed and click [Add] button. Min. value “1” to max. value “99,999,999” can be set. To remove, select the shutter speed and click [Delete] button or click [Remove all] button.
(C)	List of resolutions to display	Check “Enable” if you want MCAT to display the resolution edited here. Edit the list of resolutions that can be selected on MCAT. To add, enter the resolution in “Width” x “Height” and click [Add] button. Min. value “1” to max. value “99,999,999” can be set. To remove, select the resolution and click [Delete] button or click [Remove all] button.
(D)	OK	Applies the settings and closes this screen.
(E)	Cancel	Closes the screen without applying the changed settings.

## ■ MCAT list 2

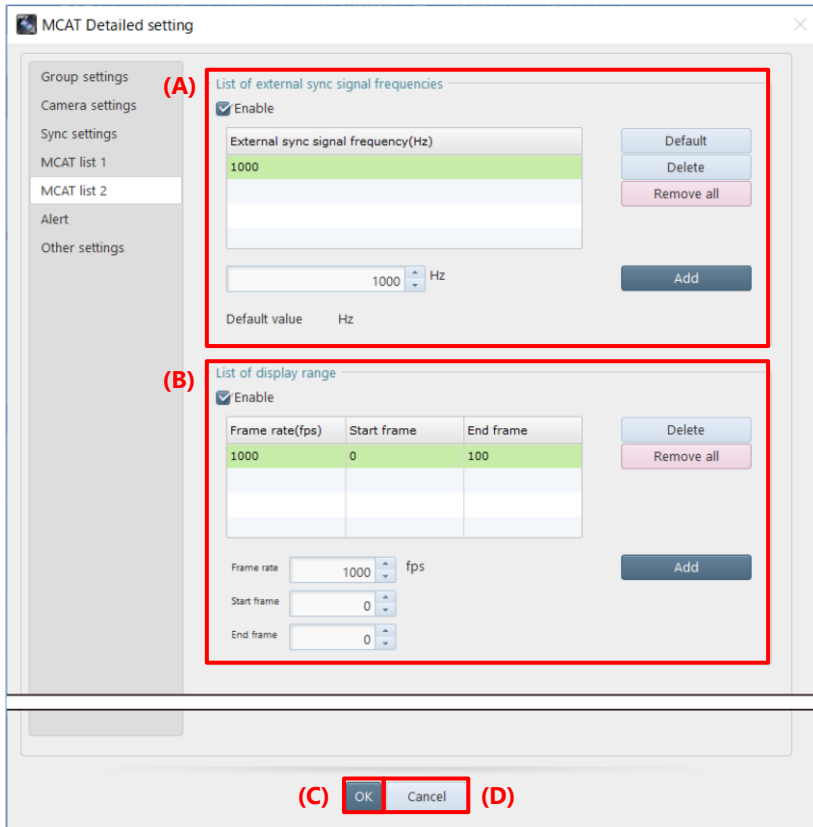

Item	Name	Function
(A)	List of external sync signal frequencies	<p>Check “Enable” if you want MCAT to display the external sync signal frequencies edited here.</p> <p>Edit the list of external sync frequencies that can be selected on MCAT. To add, enter the frequency and click [Add] button. Minimum value “1” to maximum value “99,999,999” can be set.</p> <p>To remove, select the frequency to be removed and click [Delete] button or click [Remove all] button.</p> <p>To return the default value, click [Default] button. The default value is displayed as “Default value XX Hz”.</p>
(B)	List of display range	<p>Edit the list of save range that can be selected on MCAT.</p> <p>To add, enter the frame rate, start frame, and end frame. Then, click [Add] button. For frame rate, minimum value “1” to maximum value “99,999,999” can be set. For start/end frame, minimum value “-2,147,483,647” to maximum value “2,147,483,647” can be set.</p> <p>To remove, select the range to be removed and click [Delete] button or click [Remove all] button.</p>
(C)	OK	Applies the settings and closes this screen.
(D)	Cancel	Closes the screen without applying the changed settings.

## ■ Alert

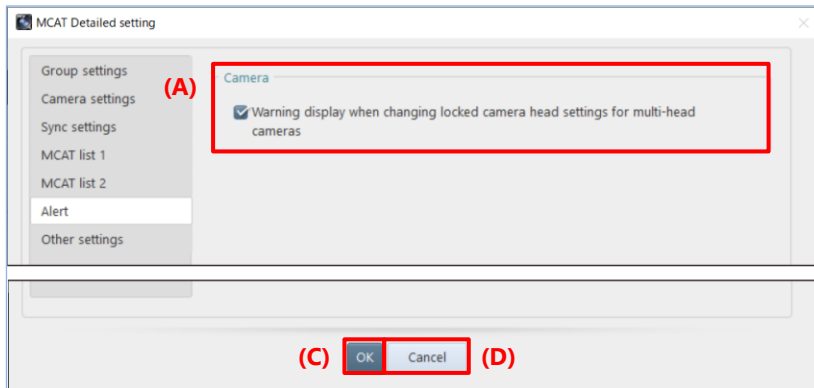

Item	Name	Function
(A)	Warning display when changing settings for locked heads of a multiple cameras	If checked, a confirmation message will be displayed when changing the settings for an unlocked head on a camera with multiple heads, asking if you want to apply the same settings to the locked heads.
(B)	OK	Applies the settings and closes this screen.
(C)	Cancel	Closes the screen without applying the changed settings.



## ■ Other settings



Item	Name	Function
(A)	Synchronize at the start of recording	If checked, synchronization is performed at the start of recording.
(B)	Order of MCAT Table Items	Clicking the [Reset] button returns the order of items in the MCAT table to its initial state.
(C)	MCAT Table Background Color	The background color of the table in “Ready for recording”, “Recording in progress”, and “Save mode” can be set. Click the [Reset] button to reset to the following default colors. <ul style="list-style-type: none"> <li>· Ready for recording: Green</li> <li>· Recording in progress: Orange</li> <li>· Save mode: Light Blue</li> </ul>
(D)	OK	Applies the settings and closes this screen.
(E)	Cancel	Closes the screen without applying the changed settings.

## ■ MCAT Table

### Camera Info tab

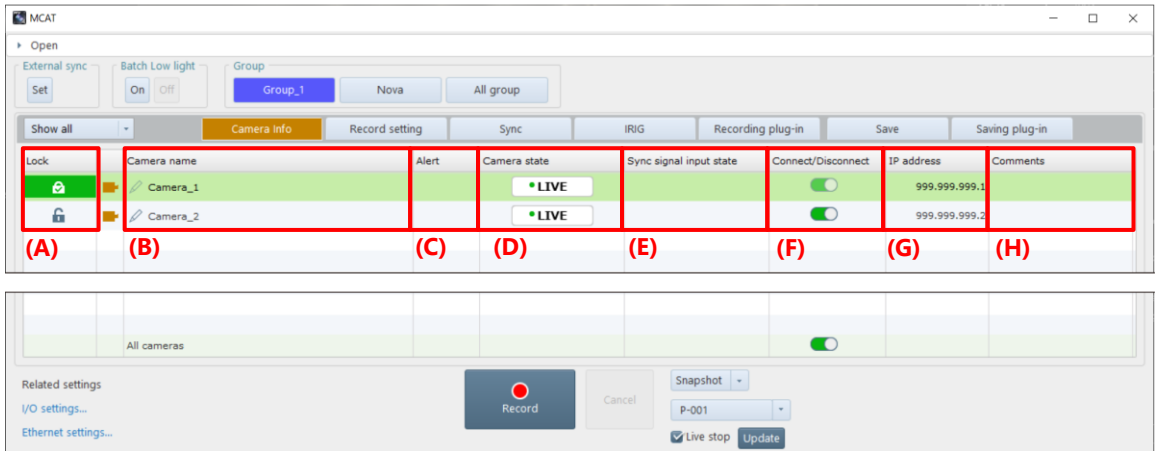

Item	Name	Function
(A)	Lock	Click to lock the camera so that its settings cannot be changed. Locked cameras cannot be changed their settings via PFV4 Mobile.
(B)	Camera name	The camera name is displayed. Click the [Edit] icon to check and change the camera name and IP address. For details, see “4.2.3 Changing Camera Name and IP Address” on page 54.
(C)	Alert	If there is a problem with the camera, the following alerts will be displayed. <ul style="list-style-type: none"> <li>• Initial startup error</li> <li>• Device warning error</li> <li>• Fan status error</li> <li>• Temperature warning</li> <li>• Acceleration sensor error</li> </ul>
(D)	Camera state	The status of the camera is displayed. For details, see “4.1.2 Information Items” on page 43. <ul style="list-style-type: none"> <li>• LIVE</li> <li>• Ready</li> <li>• Recording</li> </ul>
(E)	Sync signal input state	The status of the sync signal input is displayed. For details, see “4.1.2 Information Items” on page 43. <ul style="list-style-type: none"> <li>• No Sync</li> <li>• Sync In</li> <li>• Over Sync</li> <li>• not supported</li> </ul>
(F)	Connect/Disconnect	Click the toggle button to connect or disconnect the camera.
(G)	IP address	Displays the camera IP address.
(H)	Comments	Display/edit comments. Multiple lines of comments can be entered, and only the first line is displayed in the cell. When the mouse is moved closer, all lines are displayed with a tooltip.

## Record setting tab

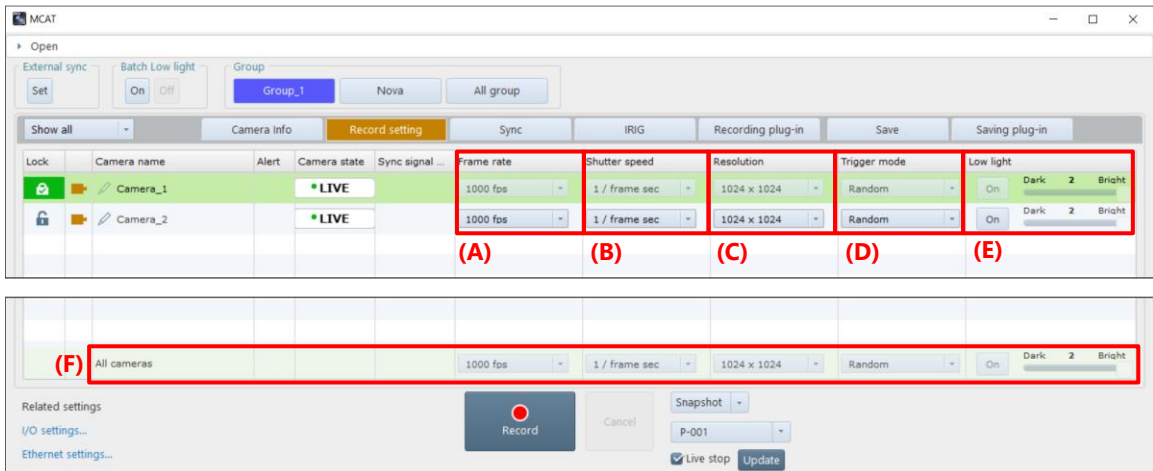

Item	Name	Function
(A)	Frame rate	Select the frame rate from the drop-down list. To add or remove items from the drop-down list, see “MCAT list 1” on page 274.
(B)	Shutter speed	Select the shutter speed from the drop-down list. To add or remove items from the drop-down list, see “MCAT list 1” on page 274. The “Auto Exposure”, “Dual Slope Shutter”, and “Shutter Lock” do not appear in the list.
(C)	Resolution	Select the resolution from the drop-down list. To add or remove items from the drop-down list, see “MCAT list 1” on page 274. The “Resolution Lock” does not appear in the list.
(D)	Trigger mode	Select the trigger mode from the drop-down list. The “Hardware Image Trigger” does not appear in the list.
(E)	Low light	Turn on/off low light. The brightness of the low light can be adjusted by the slider.
(F)	All cameras	Above settings can be made at once, except for locked cameras.

## Sync tab

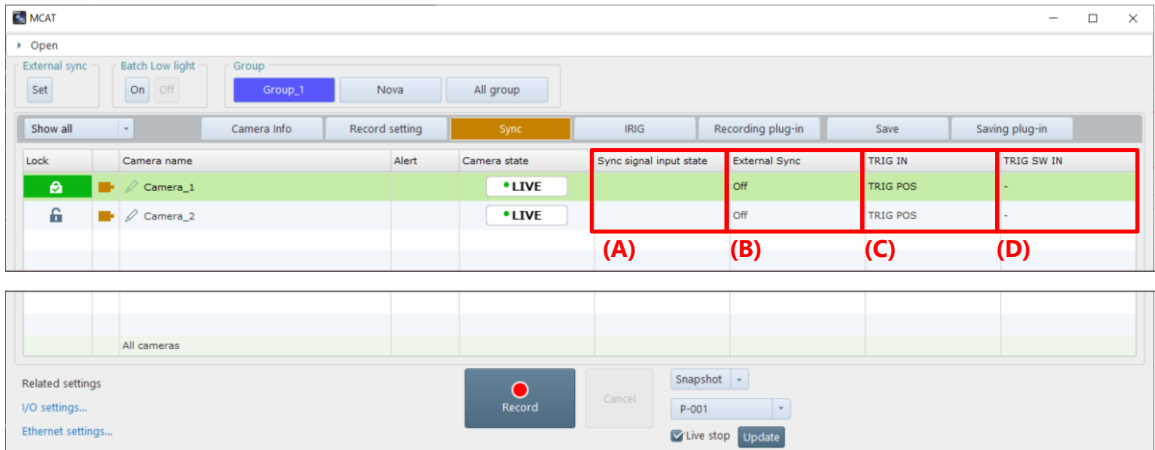

Item	Name	Function
(A)	Sync signal input state	The status of the sync signal input is displayed.
(B)	External Sync	Displays the type and polarity of the signal input to the SYNC IN connector.
(C)	TRIG IN	Displays the polarity of the signal input to the TRIG IN connector.
(D)	TRIG SW IN	Displays the type and polarity of the signal input to the TRIG SW IN connector.

## IRIG tab

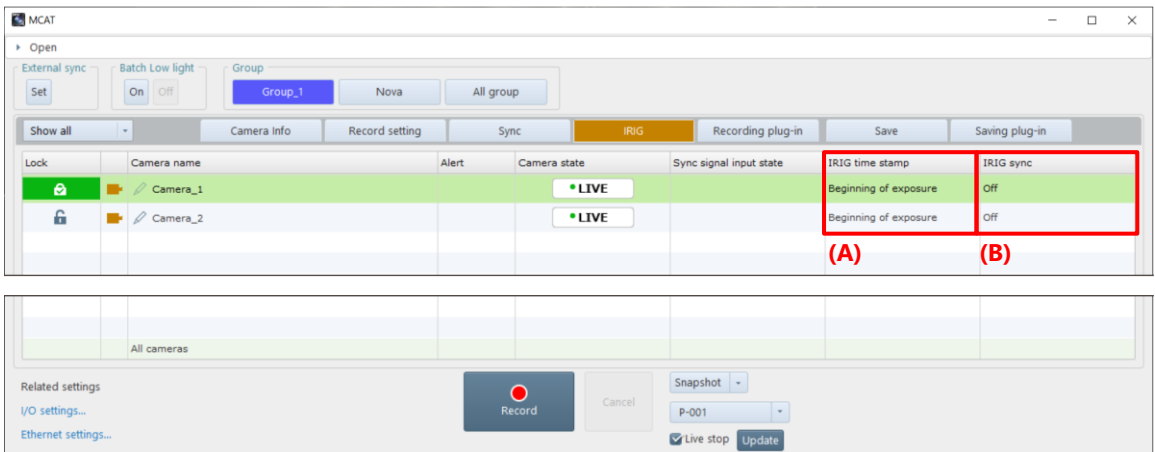

Item	Name	Function
(A)	IRIG time stamp	Displays IRIG timestamp on/off; if on, displays IRIG sampling timing and exposure start/end.
(B)	IRIG sync	Displays IRIG synchronization on/off.

## Record plug-in tab

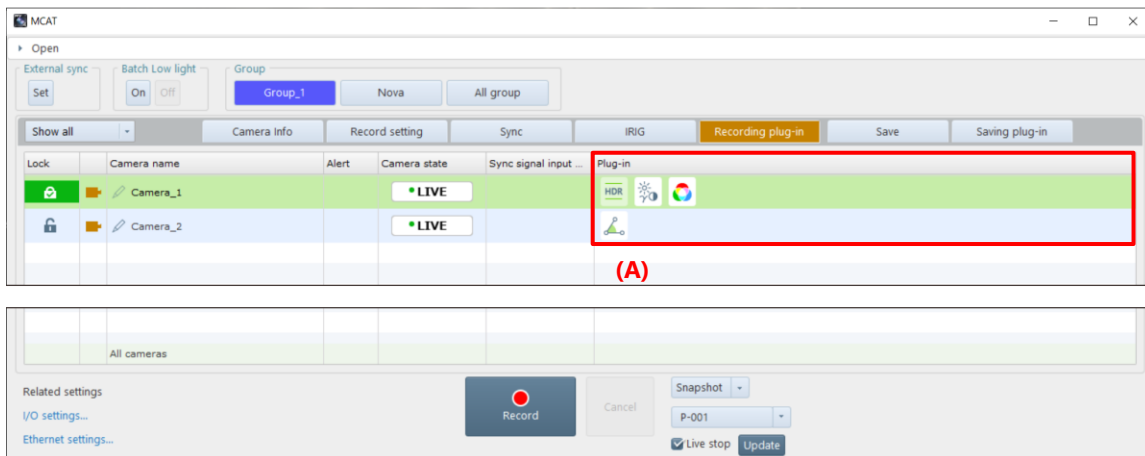

Item	Name	Function
(A)	Plug-in	Displays a list of plug-in icons that are being applied in LIVE mode.

## Save tab

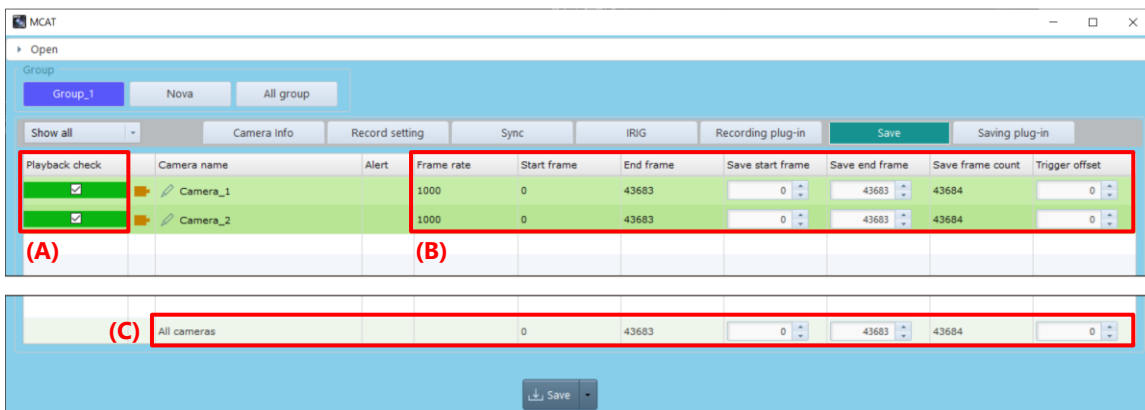

Item	Name	Function
(A)	Playback check	Add a check to indicate that you have checked the playback before saving. You can save the data without playback check, but a confirmation message will appear when you click the [Save] button.
(B)	Save info	Displays information about the data to be saved. <ul style="list-style-type: none"> <li>• Frame rate: Frame rate of recorded data</li> <li>• Start frame: Start frame of recorded data</li> <li>• End frame: End frame of recorded data</li> <li>• Save start frame: Start frame of saved range</li> <li>• Save end frame: End frame of saved range</li> <li>• Save frame count: Total frames in saved range</li> <li>• Trigger offset: Number of offsets from real trigger frame when virtual trigger frame is set.</li> </ul>
(C)	All cameras	Above settings can be made at once.

## Saving plug-in tab

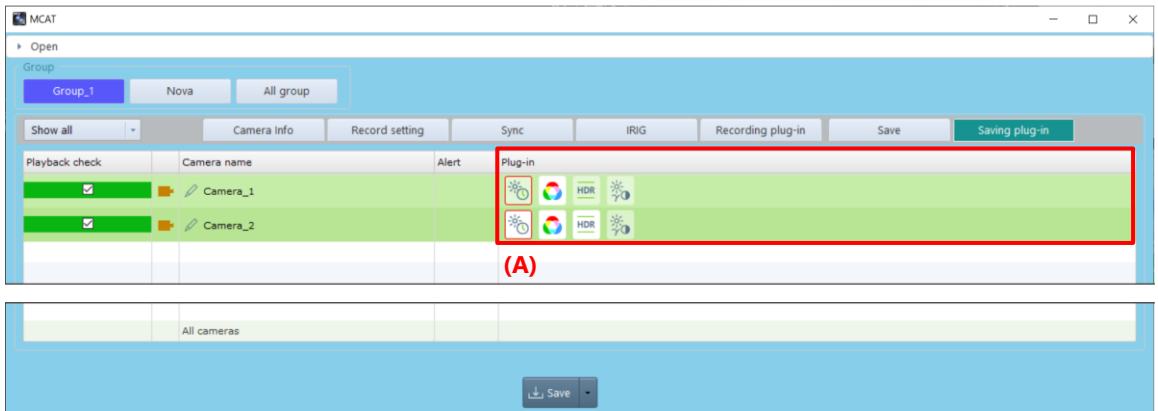

Item	Name	Function
(A)	Plug-in	Displays a list of plug-in icons that are being applied in MEMORY mode.

## 8.8. Turning ON/OFF Image Edit Effects

Some of the settings applied to an image by using the tool menu etc. are displayed and accumulated as icons on the effect status bar.

Click the icon of the effect status bar to cancel the application of the setting of the icon. Click the same icon to apply it again.

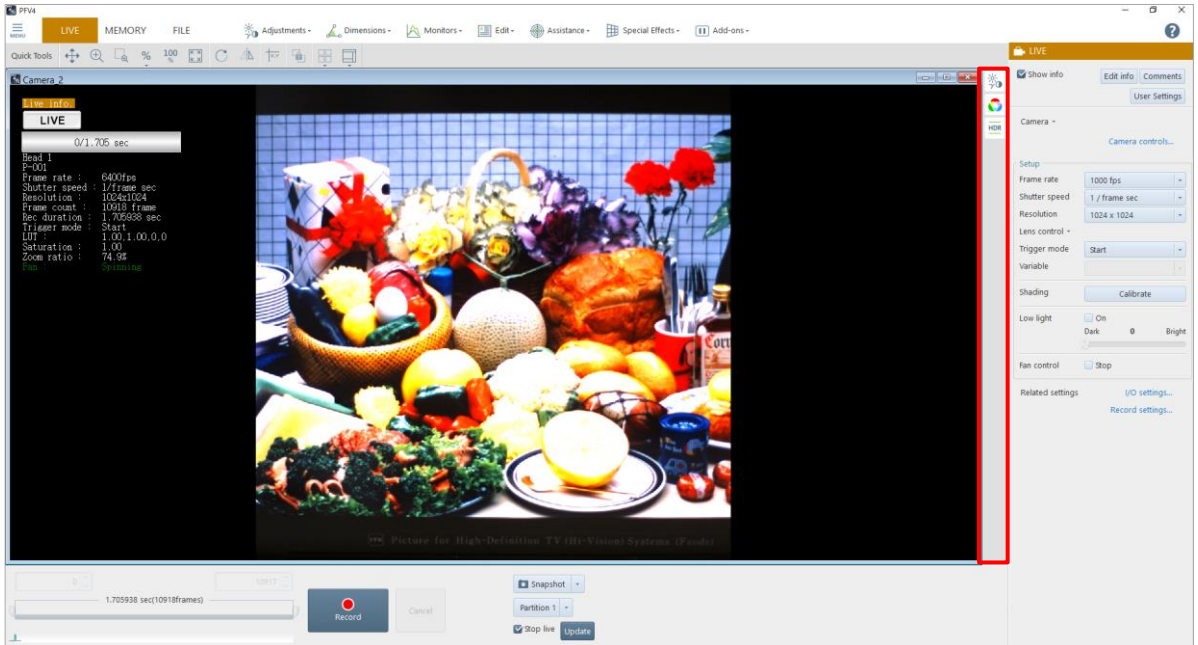

When an effect is applied to an image by clicking the [Apply] or [OK] button on the function panel of each function, the icon of the corresponding function will be added to the effect status bar.

A menu is shown by right clicking. Click [Open] to set up. Click [Delete] to delete the added icon.

When icons are added to the effect status bar, some settings can be applied at a time; however, the setting being applied will end by applying the other setting. The following effects cannot be used in combination with each other. When one effect is applied, the other effect will be canceled.

- Pseudo color view
- Histogram view
- Line profile view
- Brightness change view
- Overlaying image
- Focus assistance
- Overexposure warning

In addition, since effects can be applied to each camera, icons to be displayed also vary with the selected camera.

### NOTE

- The information displayed on the effect status bar is saved for each mode. When you change LIVE/MEMORY mode to FILE mode and vice versa, icons to be displayed will also change.
- In changing between LIVE and MEMORY modes, all the icons except those of mode-specific functions continue to be displayed.

## 8.9. Keyboard Shortcut

Keyboard shortcuts are assigned to each button or operation to execute the command. You can execute the command from the keyboard without clicking any buttons or operations.

Keyboard Shortcut	Function	Remark
[Ctrl] + [Z]	Undo	
[Ctrl] + [Y]	Redo	
[Ctrl] + [C]	Snapshot (copy to clipboard)	
[F1]	Move to LIVE mode.	
[F2]	Move to MEMORY mode.	
[F3]	Move to FILE mode.	
[F10]	Open [Configuration] menu.	
[Ctrl] + [Q]	Exit PFV4.	
[Tab]	Switch windows (forward).	
[Shift] + [Tab]	Switch windows (reverse).	
[Arrow] keys	Move cross cursor, selected point, or selected area.	The behavior changes depending on the plug-in function. See the Arrow keys operation for details.
[U]	Reverse playback	Operation in MEMORY and FILE mode
[I]	Pause	Operation in MEMORY and FILE mode
[O]	Playback	Operation in MEMORY and FILE mode
[H]	Move to the start frame.	Operation in MEMORY and FILE mode
[J]	Backward one frame.	Operation in MEMORY and FILE mode
[K]	Forward one frame.	Operation in MEMORY and FILE mode
[L]	Move to the end frame.	Operation in MEMORY and FILE mode
[N]	Move to the trigger frame.	Operation in MEMORY and FILE mode
[M]	Enable / disable virtual trigger.	Operation in MEMORY and FILE mode
[.] (period)	Move to the event frame.	Operation in MEMORY and FILE mode
[F]	Set the current frame as the end frame.	Operation in MEMORY and FILE mode
[S]	Set the current frame as the start frame.	Operation in MEMORY and FILE mode
[Shift] + [Enter]	Set to record ready / Start recording.	Operation in LIVE mode
[Shift] + [Delete]	Cancel / stop recording.	Operation in LIVE mode
[W]	Adjusts the display to the resolution of the loaded image.	
[E]	Fit the image size to the view window.	
[R]	Rotate the image.	Rotate by one unit as mouse operation for each press.
[T]	Invert the image.	Flip by one unit as mouse operation for each press.
[+]	Zoom in the displayed image.	Zoom in by one unit as mouse operation for each press.
[-]	Zoom out the displayed image.	Zoom out by one unit as mouse operation for each press.
[Esc]	Deactivate Quick Toolbar menu selection. Exit "Multi points" function of "Measurements".	Operation in Measurements menu
	Release the operation.	Operation in common
	Cancel	Operation in MEMORY and FILE mode Common operation for the [Save] screen
[Delete]	Delete the measurement result selected in the "Dimensions".	



Keyboard Shortcut	Function	Remark
[Ctrl] + [O]	Open files.	Operation in FILE mode
[Ctrl] + [W]	Close all files.	Operation in FILE mode
[Shift] + [Up/Down] key	Change frame rate.	Operation in LIVE mode Raise or lower the value by one step from the currently selected value.
[Shift] + [Right/Left] key	Change shutter speed.	Operation in LIVE mode Raise or lower the value by one step from the currently selected value.
[Ctrl] + [S]	Open [Save] screen. Apply	Operation in MEMORY and FILE mode Operation in MEMORY and FILE mode Common operation for the [Save] screen
[Ctrl] + [L]	Open [Layout save] screen.	Operation in MEMORY and FILE mode
[Ctrl] + [Enter]	Determination	Operation in MEMORY and FILE mode Common operation for the [Save] screen
[Ctrl] + [Up/Down] key	Switch the selected camera on the camera list or on the MCAT table.	Operation in LIVE mode and MEMORY mode

## ■ Arrow keys operation

The corresponding functions and operations for moving selection point and selection area are shown below.

### Move selection point and area

Operation	Supported Function
Press the [Arrow] keys to move the mouse position by one pixel before confirming and press the [Enter] key to confirm.	Cross cursor, Measurements, and Manual Tracking
During dragging the mouse, press the [Arrow] keys to move the mouse position by one pixel, and release the mouse to confirm the position.	Calibration and Keystone Correction
Press the [Arrow] key to move the selected area by one pixel during dragging the mouse or the mouse is hovering (mouse is in the cross-marked state).	Stabilization
Press the [Arrow] keys to change the shape of the rectangle. Press the [Shift]+[Arrow] keys to move the rectangle.	LUT/Bit-Shift, Color Correction (White Balance), Brightness Change, Hardware Image Trigger, Software Image Trigger, Variable setting, Trimming, and Auto Focus















## CAUTION

When Cross Cursor is enabled, the [Arrow] key shortcuts for other plug-ins are not available.

## 8.10. Quick Toolbar

Here, the functions available on the quick toolbar are described. You can use them by clicking icons or selecting items from the list displayed with a mouse cursor. Moreover, they can be used in combination with the tool menu functions.

Item	Name	Function
	Move	After clicking the button, dragging on the view window scrolls the displayed image in the direction dragged.
	Zoom	After clicking the button, dragging up and down on the view window enlarges and shrinks the display respectively.
	Enlarge	After clicking the button, drawing a square by dragging on the view window enlarges this specified area.
	Scale factor	After clicking the button, selecting the desired scaling factor from the displayed list scales the display by that factor.
	Same magnification in pixel	Adjusts the display to the resolution of the loaded image.
	Fit	Automatically adjusts the scaling factor to fit the whole image to the view window. Clicking the depressed button again returns the scaling factor to 100%.
	Rotate	After clicking the button, dragging up and down on the view window turns the image 90 degrees right and left respectively.
	Reverse	After clicking the button, dragging up on the view window flips the image in the order: horizontally, vertically, and both horizontally and vertically. Dragging down there flips it in the order: both horizontally and vertically, vertically, and horizontally.
	Cross cursor	After clicking the button, moving a mouse pointer onto the view window shows a cross cursor (cursor 1). The coordinates and RGB values of the pointed position are displayed. By clicking any position on the view window, you can fix the cross cursor (cursor 1) at there. Double-clicking on the view window shows a cursor 2. By double-clicking there again, you can return the target to the cursor 1. Clicking the icon again hides the cursors. Select "Lock active cursor at center" to fix the cross cursor to the center of the view window.
	Multi-lock	After clicking the button, new settings made will be applied to all the view windows displayed currently.
	Window alignment	Aligns view windows when multiple windows and graphs are displayed. Select an alignment method from the list to be displayed by clicking.
	Panel display switching	Allows you to show/hide the recording/playback panel and the function panel, and toggle full screen mode on and off. Select the desired option from the list to be displayed by clicking.

# 9

## Chapter 9 Side Menu

This chapter describes the settings available through the side menu to be displayed by clicking the menu button.

# 9.1. What Side Menu Does

The side menu is a menu to be displayed by clicking the menu button in the upper-left corner of the screen. This menu allows the following settings and information displays. See the references for details.

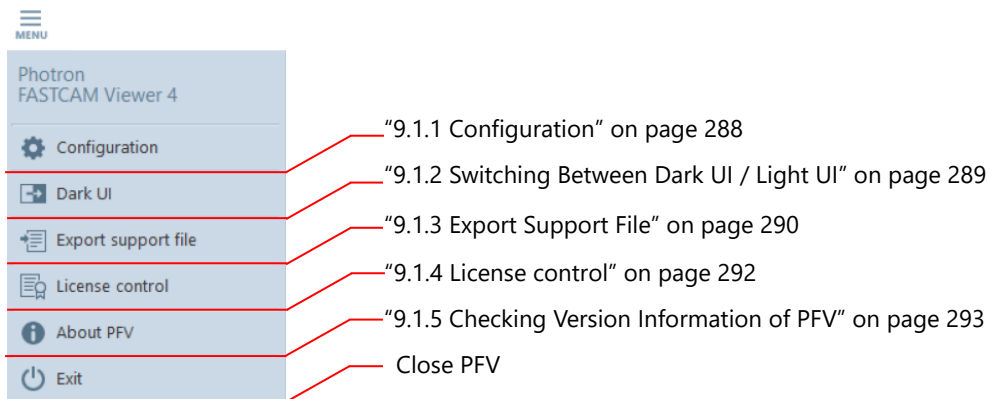

## 9.1.1. Configuration

Clicking [Configuration] on the side menu displays the detailed settings. The detailed settings allow various settings about PFV and cameras.

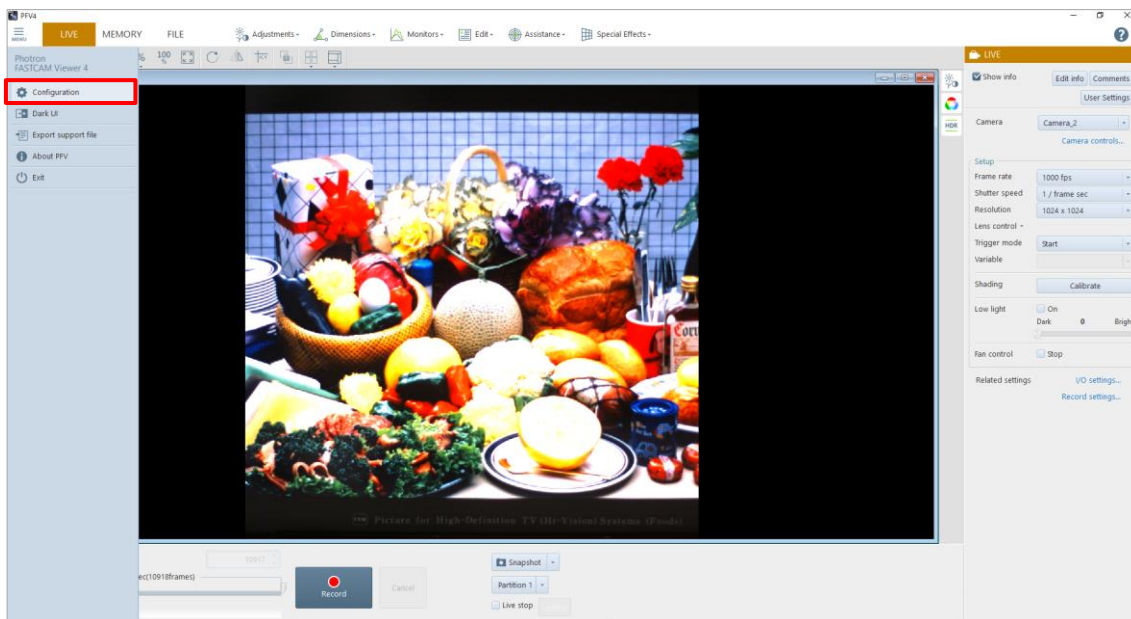

### REFERENCE

See "Chapter 10 Detailed Setting" on page 294.

## 9.1.2. Switching Between Dark UI / Light UI

Clicking [Dark UI] on the side menu switches to the dark UI. In a state of dark UI, [Light UI] is displayed on the side menu. Clicking it switches to the light UI.

### Dark UI

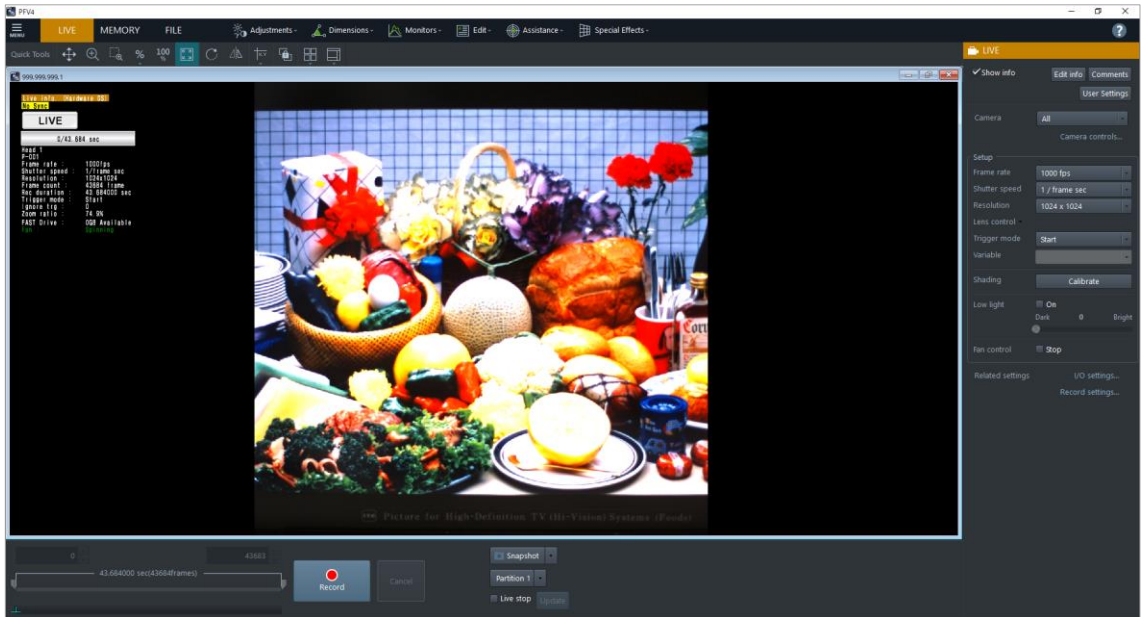

### Light UI

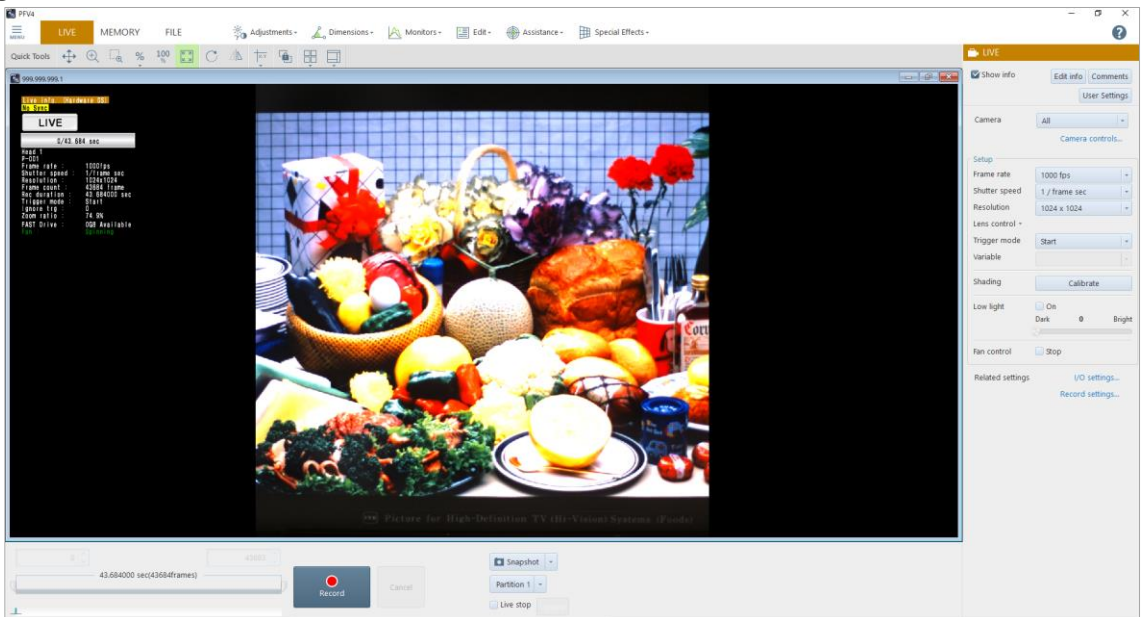

## 9.1.3. Export Support File

If an accident occurs in software or hardware while PFV is used, the information at that time will be saved, including set values of the software/hardware and a screen capture. The file is saved in ZIP format.

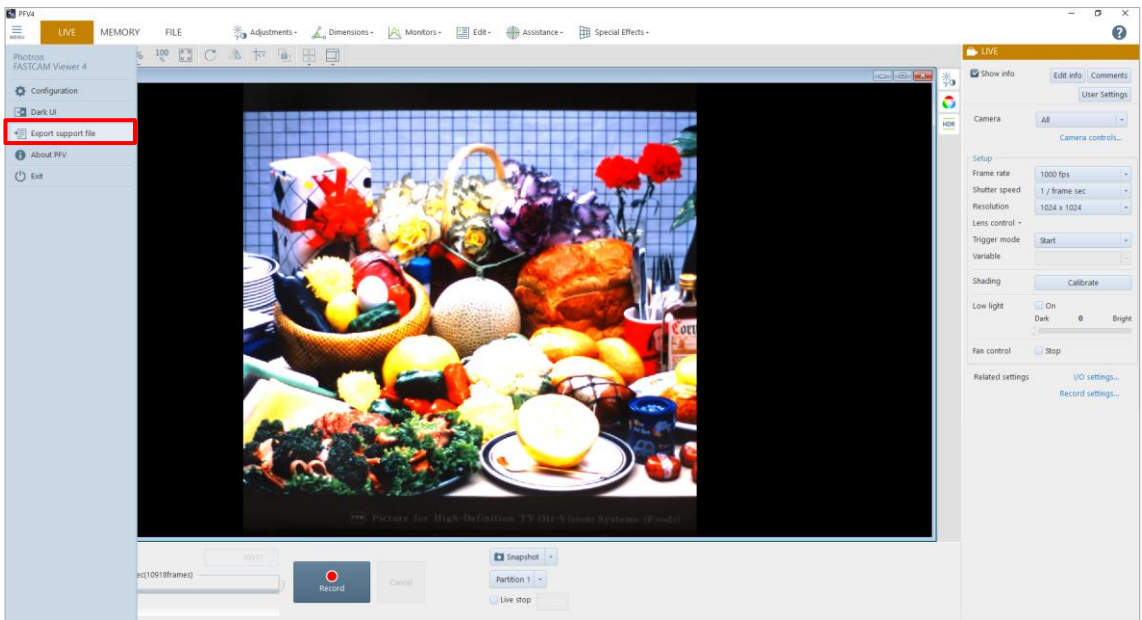

Contents to be saved to the ZIP file are as follows.  
If an accident occurs, send this file to our technical support.

- \*.pcsx  
Device control setting information saved in PFV4
- pfv4.ini  
General setting information of PFV
- pfv\_yyyymmdd.log (“yyyy mm dd” shows a date)  
Log information
- environment.txt  
PC configuration information
- version.txt  
Version information
- screenshot.png  
Current PFV4 screen (saved as a screen shot)
- Capture file  
Image capture of connected camera (in LIVE mode or MEMORY mode) or image capture in file list (in FILE mode)
- pdclib\_yyyymmdd.log (“yyyy mm dd” shows a date)  
SDK operation log
- pdclib.xml  
SDK setting log
- IGETHER\_yyyymmdd.log (“yyyy mm dd” shows a date)  
SDK Communication-related log
- \*.CIHX  
Camera information file to open the capture file

The procedure to export a support file is as follows.

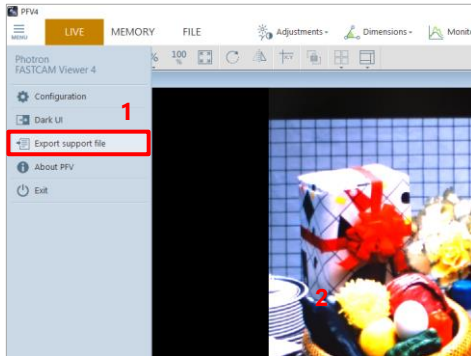

1. Click [Export support file] on the side menu.

The “Confirmation” screen is displayed.

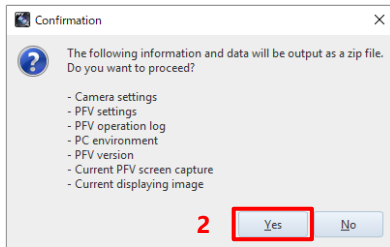

2. Click the [Yes] button.

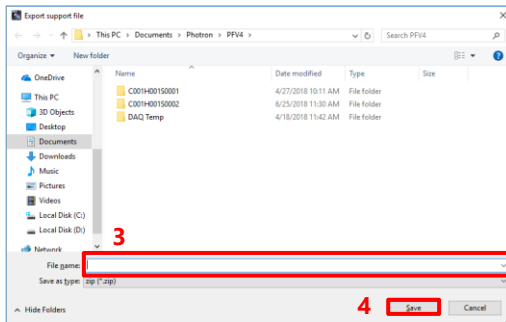

3. Specify the destination and filename.

4. Click the [Save] button.

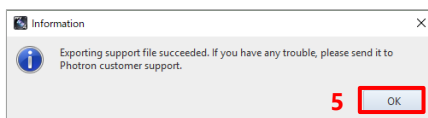

5. Click the [OK] button.

The file is saved in ZIP format.

## 9.1.4. License control

You can manage licenses for PFV4 paid plug-ins.

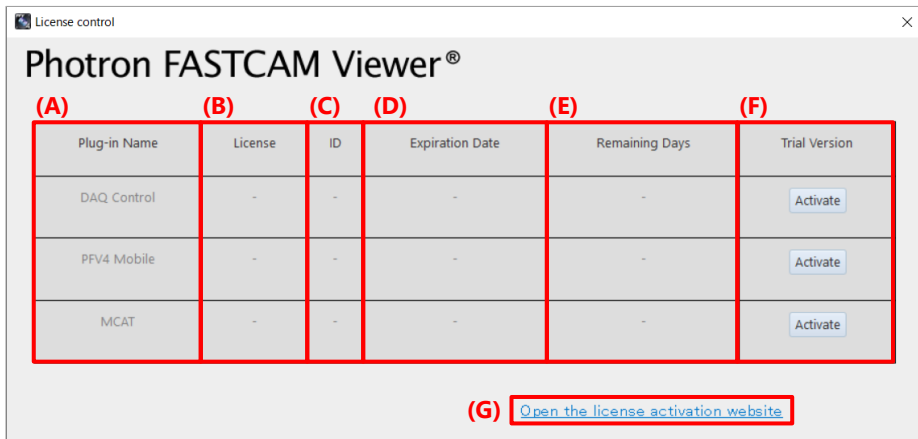

Item	Name	Function
(A)	Plug-in Name	Displays the name of the plug-in. Available licenses are displayed in black.
(B)	License	Displays the type of license (“Dongle”, “Node Lock”, or “Trial Version”). If there is no license, “-” will be displayed.
(C)	ID	Displays the Code Meter ticket ID and HASP serial number.
(D)	Expiration Date	Displays the expiration date of the license. For Code Meter permanent license or HASP USB dongle license, “Permanent Version” is displayed. When the number of days remaining on the license is less than 90 days (7 days for the trial version), it will be displayed in red.
(E)	Remaining Days	Displays the number of days remaining until the license expiration date. <ul style="list-style-type: none"> <li>Permanent License: Permanent Version</li> <li>Subscription License: number of days the license is valid (e.g., 360)</li> <li>Trial Version: number of days trial version is valid (e.g., 60)</li> <li>License expired: 0</li> <li>No license: -</li> </ul>
(F)	Trial Version	Clicking the [Activate] button activates the trial version license. The trial version expires 60 days after activation is performed.
(G)	Open the license activation website	Access Code Meter’s activation site. Refer to “Photron Software License Activation Guide” for how to activate the license.



## 9.1.5. Checking Version Information of PFV

Clicking [About PFV] on the side menu displays the “About PFV” screen, where you can check the version of PFV and the versions of components.



The description of items on the screen is as follows.

Item	Name	Function
(A)	PFV version	Displays the executable file of PFV and its version.
(B)	Component versions	Displays the versions of executable and DLL files contained in PFV. However, the version of the executable file of PFV is not displayed.

# 10

## Chapter 10 Detailed Setting

This chapter describes the detailed menu to be displayed by clicking the menu button in the upper-left corner of the screen.

# 10.1. Camera Connection Settings

This screen allows the settings about camera connection.

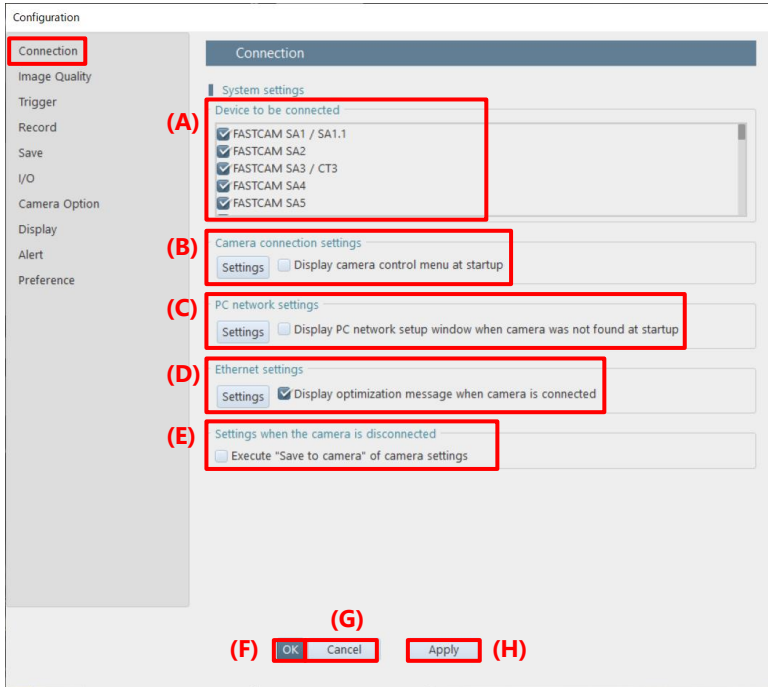

Item	Name	Function
(A)	Device to be connected	Check the cameras to which you will connect.
(B)	Camera connection settings	Settings about connection with the cameras are made on the [Camera connection settings] screen to be displayed by clicking the [Settings] button. Checking “Display camera control menu at startup” will display the function panel “Camera Controls” on startup.
(C)	PC network setting	Settings about connection with the PC are made on the [PC Network Setup] screen to be displayed by clicking the [Settings] button. For the setting procedure, see “3.1.3 Changing PC’s IP Address” on page 31. Checking “Display PC network setup window when camera was not found at startup” will display the [PC Network Settings] screen if no connectible device is recognized on startup.
(D)	Ethernet settings	Click the [Settings] button to configure Ethernet settings. For details, see “10.1.2 [Ethernet settings] Screen” on page 296. Checking “Display optimization message when camera is connected” will display a message prompting optimization when the camera is connected.
(E)	Settings when the camera is disconnected	Checking [Execute “Save to camera” of camera settings] enables the preset saving to the camera when the camera is disconnected.
(F)	OK	Applies the settings and closes this screen.
(G)	Cancel	Closes the screen without applying the changed settings.
(H)	Apply	Applies the settings.

## 10.1.1. [Camera Connection Settings] Screen

This screen allows the settings for searching for cameras with their IP addresses.

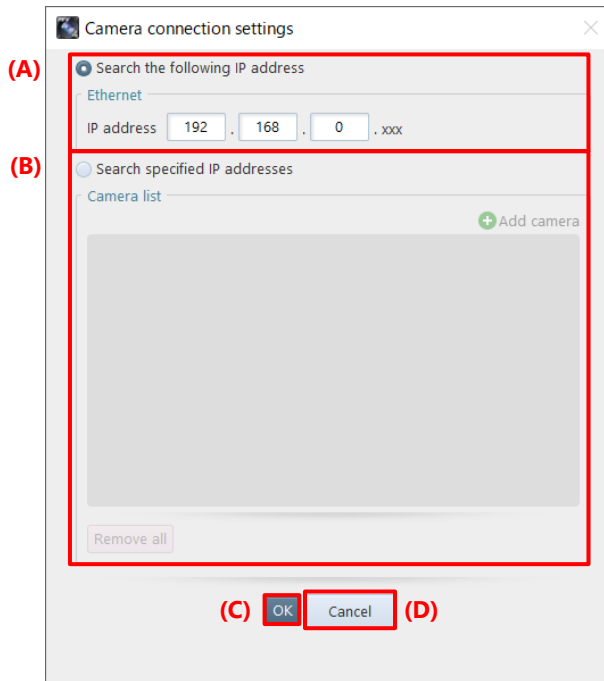

Item	Name	Function
(A)	Search the following IP address	Choose this to search for cameras automatically. Enter the high-order address of cameras' IP addresses in "IP address".
(B)	Search specified IP addresses	Clicking it will allow you to add, select, edit, and delete cameras from "Camera list". The operating procedure is the same as that for the [DEVICE SETTINGS] panel. For details, see "4.2 Camera Controls Menu" on page 50.
(C)	OK	Applies the settings and closes this screen.
(D)	Cancel	Closes the screen without applying the changed settings.

### NOTE

Ethernet send/receive ports are automatically assigned at each PFV4 startup (1 to 65535).  
To specify a specific send/receive port, contact our technical personnel.

## 10.1.2. [Ethernet settings] Screen

This screen allows either manual or automatic optimization of the packet settings.  
For the procedures of optimization, see the “3.1.4 Optimizing Ethernet Settings” on page 33.

The screenshot shows the 'Ethernet settings' interface. It is divided into 'Common settings' and 'Individual settings' sections. In the 'Common settings' section, there are three dropdown menus: 'Packet size' (A) set to 'AUTO', 'Packet count' (B) set to '128', and 'Packet interval mode' (C) with options 'Normal', '10GbE', and 'Normal (1Gbps equivalent)'. A 'Reset' button (D) is located to the right. The 'Individual settings' section (E) contains a table with columns: 'Camera', 'Apply common...', 'Packet size', 'Packet count', 'Interval (1GbE)', and 'Interval (10GbE)'. The table lists two cameras: 'Camera\_1 (999.999.999.1)' and 'Camera\_2 (999.999.999.2)'. Below the table is a checkbox 'Apply common settings' (F). At the bottom, there are two more dropdown menus for 'Packet size' (A) and 'Packet count' (B), a 'Packet interval mode' dropdown (C), a 'Reset' button (D), an 'Optimize' button (G), and 'OK' (H) and 'Cancel' (I) buttons.

Item	Name	Function
(A)	Packet size	Select a value from the following. AUTO (0), 1458, 1994, 2994, 3994, 4994, 5994, 6994, 7994, and 8986
(B)	Packet count	Select a value from the following. 1, 2, 4, 8, 16, 32, 64, 128, 256, 512, and 1024
(C)	Packet interval mode	If connection with the cameras is unstable depending on the PC, configure this value. Set the value to “Slow mode” to make the packet interval time longer. It stabilizes the communication but reduces the communication rate. <ul style="list-style-type: none"> <li>1GbE Connection: Setting for 1GbE-supported camera (Setting value: Slow mode, Normal)</li> <li>10GbE Connection: Setting for 10GbE-supported camera (Setting value: Slow mode, Normal (1Gbps equivalent), 2 to 18, and Fastest)</li> </ul> A larger value increases the communication rate and the chance of packet loss at the same time.
(D)	Reset	Resets the settings to default.
(E)	Camera list	Displays a list of cameras. Select the camera you want to configure from the list and perform each setting. You can select multiple cameras by selecting them while holding down the [Ctrl] or [Shift] keys, and then uncheck [Apply common settings] to make individual settings.
(F)	Apply common settings	Uncheck this to configure the settings (A) to (D) for each camera. Check this to apply each setting in the Common Settings field.

Item	Name	Function
(G)	Optimize	Optimizes the packet settings (packet size, packet count, and packet interval), the PC's network card settings, and the power settings automatically. For details of the optimization, refer to the "3.1.4 Optimizing Ethernet Settings" on page 33.
(H)	OK	Applies the settings and closes this screen.
(I)	Cancel	Closes the screen without applying the changed settings.

## 10.2. Image Quality Settings

This screen allows the settings about camera image quality adjustment.

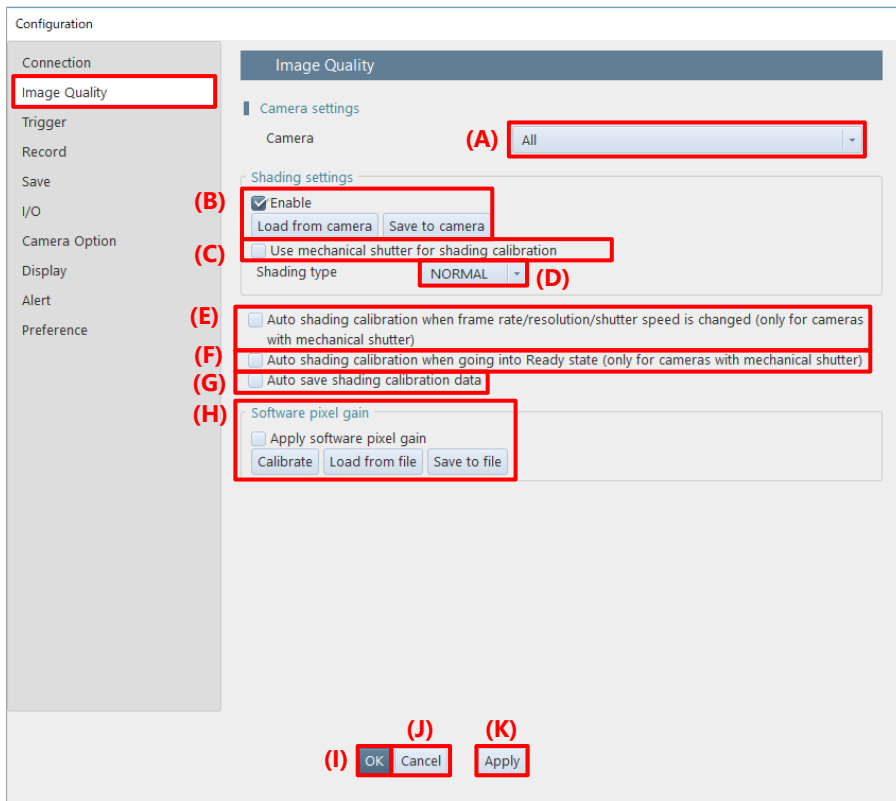

Item	Name	Function
(A)	Camera	Select a camera to set from the list to be displayed by clicking.
(B)	Enable (shading settings)	The current shading correction state of the camera is reflected in the check box. Checking/Unchecking the box turns ON/OFF the shading correction function. Clicking the [Load from camera] button read out the black level image recorded on the camera to make a shading correction. Clicking the [Save to camera] button saves the current black level image to the camera.
(C)	Use mechanical shutter for shading calibration	The current mechanical shutter state of the camera is reflected in the check box. Checking/Unchecking the box turns ON/OFF the mechanical shutter function.
(D)	Shading type	Select a shading correction method from the following. NORMAL: Standard correction FINE: Rigorous correction

Item	Name	Function
(E)	Auto shading calibration (only for cameras with mechanical shutter)	Check this to make a shading correction automatically when the frame rate, resolution, or shutter speed is changed.
(F)	Auto shading calibration when going into Ready state (only for cameras with mechanical shutter)	Check here to execute shading automatically when a camera state goes to Ready while the camera having a mechanical shutter is connected.
(G)	Auto save shading calibration data	Check this to allow the shading data to be saved automatically to the camera after the shading correction is made.
(H)	Apply software pixel gain	<p>Checking this enables independent gain adjustment for all the sensor pixels. To enable this function, you need to make a shading correction beforehand. Making both the shading correction and the pixel gain correction can eliminate the non-uniformity in pixels attributed to the camera's lighting conditions, optical system, or image sensor.</p> <p>Clicking the [Calibrate] button makes a pixel gain correction. With the image when it is selected regarded as a reference image, the gain correction information is generated to make a pixel gain correction.</p> <p>Clicking the [Load from file] button loads the saved gain correction information to make a correction.</p> <p>Clicking the [Save to file] button outputs the current pixel gain correction to the file. This correction is not reflected in the NTSC/PAL video monitor output.</p>
(I)	OK	Applies the settings and closes this screen.
(J)	Cancel	Closes the screen without applying the changed settings.
(K)	Apply	Applies the settings.



## CAUTION

[Apply software pixel gain] is an image correction only available on PFV. The corrected information will not be applied to the image data when saving destination is SD card / FAST Drive / CFast card.



# 10.3. Trigger Settings

This screen allows the settings about triggers.

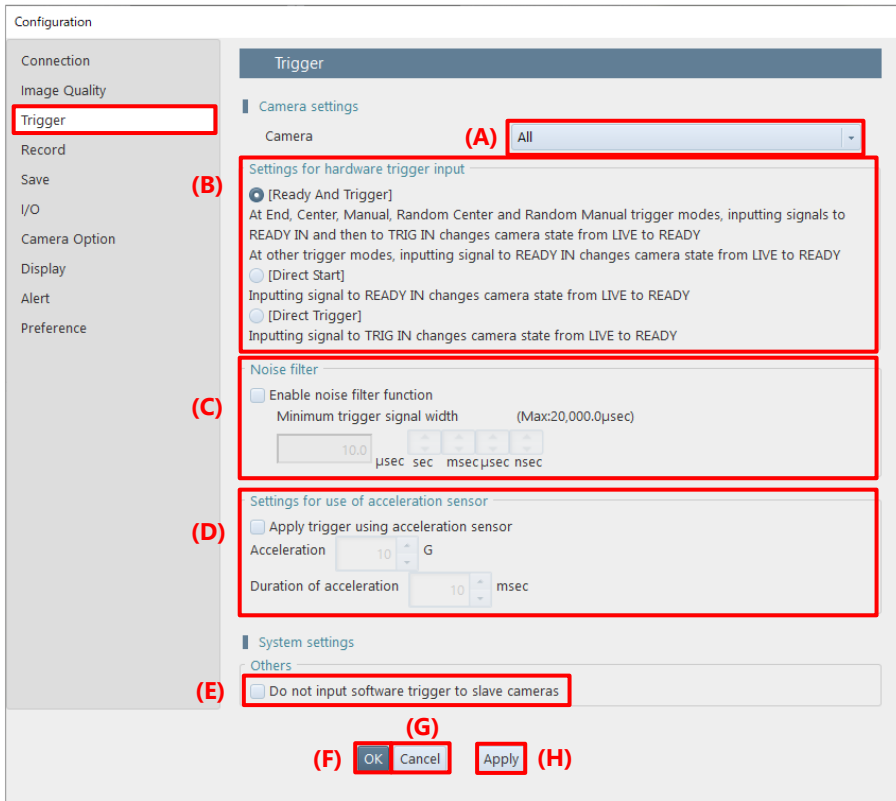

Item	Name	Function
(A)	Camera	Select a camera to set from the list to be displayed by clicking.
(B)	Settings for hardware trigger input	Select the trigger of hardware from the following. Ready And Trigger: Inputting a signal to READY IN and TRIG IN terminals in LIVE mode changes the camera state to READY. Direct Start: Inputting a Ready signal in LIVE mode changes the camera state to READY. Direct Trigger: Inputting a Trigger signal in LIVE mode changes the camera state to READY.
(C)	Enable noise filter function	Prevents incorrect trigger signals generated by voltage fluctuation. Selecting this check box enables the trigger mask function to set the trigger signal restriction width.
(D)	Apply trigger using acceleration sensor	By using an accelerometer built in a camera, a trigger can be issued. A trigger is issued when the specified acceleration and acceleration duration are exceeded. They can be specified within the range of 5 to 160 G and 1 to 100 ms, respectively.
(E)	Do not input software trigger to slave cameras	Check this not to input a trigger from PFV to the slave camera during synchronized shots with multiple cameras.
(F)	OK	Applies the settings and closes this screen.
(G)	Cancel	Closes the screen without applying the changed settings.
(H)	Apply	Applies the settings.

## 10.4. Recording Settings

This screen allows adjustment to the recording settings on a camera basis and a system-wide basis.

The settings on a camera basis are made for each camera selected by using [Camera] in “Camera settings” at the top of the screen. The settings on a system-wide basis are made in “System settings” at the bottom of the screen.

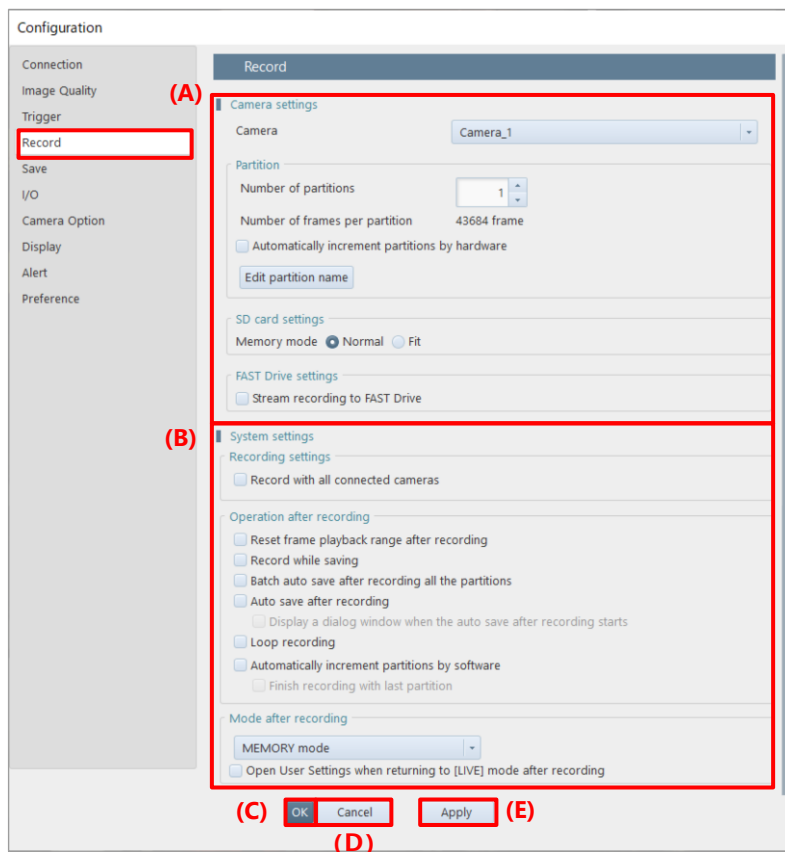

Item	Name	Function
(A)	Camera settings	Allows the settings about the camera, memory partition, SD card, and FAST Drive.
(B)	System settings	Allows the settings about the behavior after completion of recording and the mode after recording.
(C)	OK	Applies the settings and closes this screen.
(D)	Cancel	Closes the screen without applying the changed settings.
(E)	Apply	Applies the settings.

## Camera settings

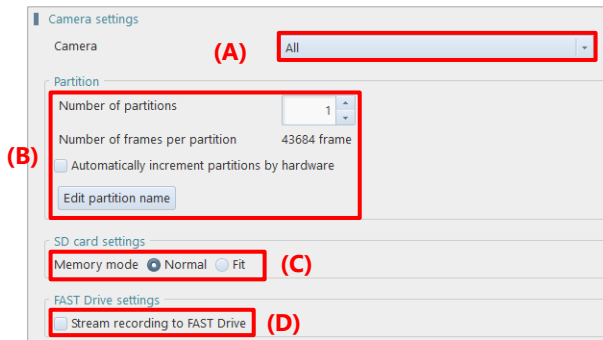

Item	Name	Function
(A)	Camera	Select a camera to set from the list to be displayed by clicking. Choosing “All” will select all the registered cameras as setting targets.
(B)	Partition	Specify the number of partitions to divide in “Number of partitions”. Check “Automatically increment partitions by hardware” to automatically increment the partition number by camera. Click the “Edit partition name” to edit the partition name.  <div style="border: 2px solid yellow; padding: 10px;"> <p> <b>CAUTION</b></p> <ul style="list-style-type: none"> <li>• Check “Automatically increment partitions by hardware” when shooting only by using a camera without using PFV.</li> <li>• Do not set this item when triggering using PFV.</li> <li>• Also, this item cannot be set together with “Direct Start”. Since “Direct Start” is set automatically when PFV4 starts, “Automatically increment partitions by hardware” always defaults to off. Check “Automatically increment partitions by hardware” again and stop PFV to automatically increment the partition number by camera.</li> </ul> </div>
(C)	Memory mode	Choose whether to enable saving to the SD card capacity in recording on the camera. Choose “Normal” or “Fit”. Choosing “Normal” will use the camera’s memory fully in recording. Choosing “Fit” will limit the camera’s memory capacity to match the SD card’s memory capacity.
(D)	Stream recording to FAST Drive	Checking this will establish the mode of direct record to FAST Drive.



## NOTE

The mode of direct record to FAST Drive is a mode to stream data directly to the FAST Drive without using the camera memory. The recordable time is calculated from the current free space of FAST Drive and displayed in “Information” - “Recordable time”. To switch modes, you need to restart the camera.

This mode has the following limitations.

- MEMORY mode cannot be used.
- Partitioning and moving partitions are disabled.
- Recording during save and automatic save after recording cannot be used in combination.
- It cannot be used in combination with loop recording.
- Automatic increment of partition is invalid. However, it is valid for cameras except in FAST Drive direct record mode.
- The mode after recording cannot be established.

## System settings



Item	Name	Function
(A)	Record with all connected cameras	Checking this uses all the connected cameras for recording. A camera that is not selected is also used for recording if the camera is connected.
(B)	Reset frame playback range after recording	Check this to reset the playback area when the recording is complete.
(C)	Record while saving	Checking this allows you to offload one partition of image data while recording to another partition simultaneously.
(D)	Batch auto save after recording all the partitions	Check this to execute auto save after recording all the partitions.
(E)	Auto save after recording	After recording is finished, a file is saved to the PC automatically. Checking “Display a dialogue when the auto save after recording starts” will display a message before the file is saved.
(F)	Loop recording	Checking this will automatically start recording again after it is finished. (A recording is made as if the [Record] button were clicked automatically.) Since recording continues while overwriting data, attention should be given if “Auto save after recording” or “Automatically increment partitions by software” is not used.
(G)	Automatically increment partitions by software	With multiple partitions, when recording on the 1st partition is finished, it continues to the next partition without overwriting data. Checking “Finish recording with last partition” will stop recording after data is written on all the partitions. Unchecking it will continue recording while overwriting data after returning to the first partition.
(H)	Mode after recording	Set the display mode of PFV after shooting is finished, from the list to be displayed by clicking [▼].
(I)	Open User Settings when returning to [LIVE] mode after recording	Check this to display the User Settings window the connected camera has recording data when returning to [LIVE] mode after the recording.

# 10.5. Save Settings

This screen allows the settings about behavior during save.

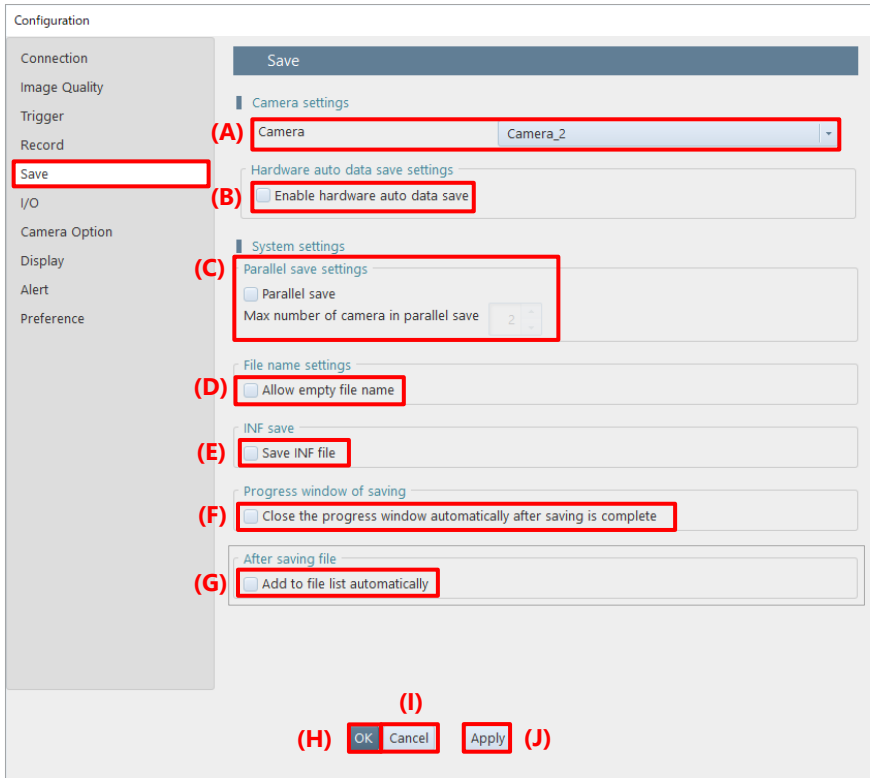

Item	Name	Function
(A)	Camera	Select a camera to be set from the list displayed by clicking. Choosing “All” will select all the registered cameras as setting targets.
(B)	Enable hardware auto data save	Enables to save the hardware data automatically.
(C)	Parallel save	Enables saving multiple images in parallel when multiple cameras are connected. In “Max number of camera in parallel save”, set the number of cameras for parallel save. Unchecking this enables saving multiple images in order.  <div style="border: 2px solid yellow; padding: 5px;"> <p><b>CAUTION</b></p> <ul style="list-style-type: none"> <li>When using a parallel save setting, provide the control PC with the same number of LAN ports as that of cameras.</li> <li>Camera heads belong to a same camera cannot be parallel-saved.</li> </ul> </div>
(D)	Allow empty file name	Checking “Allow empty file name” allows a blank filename field during save.
(E)	Save INF file	Checking “Save INF file” displays the “INF save” check box on the [Save] screen.
(F)	Close the progress window automatically after saving is complete	Checking “Close the progress window automatically after saving is complete” closes the saving progress dialog when saving is complete.
(G)	Add to file list automatically	Check this to open the saved image automatically in [FILE] mode after saving in [MEMORY] mode.

<b>Item</b>	<b>Name</b>	<b>Function</b>
(H)	OK	Applies the settings and closes this screen.
(I)	Cancel	Closes the screen without applying the changed settings.
(J)	Apply	Applies the settings.

# 10.6. I/O Settings

This screen allows the settings about I/O. Items to be displayed on this screen vary with the functions of the target camera. Here, every item is described by using the example case where all the items are displayed.

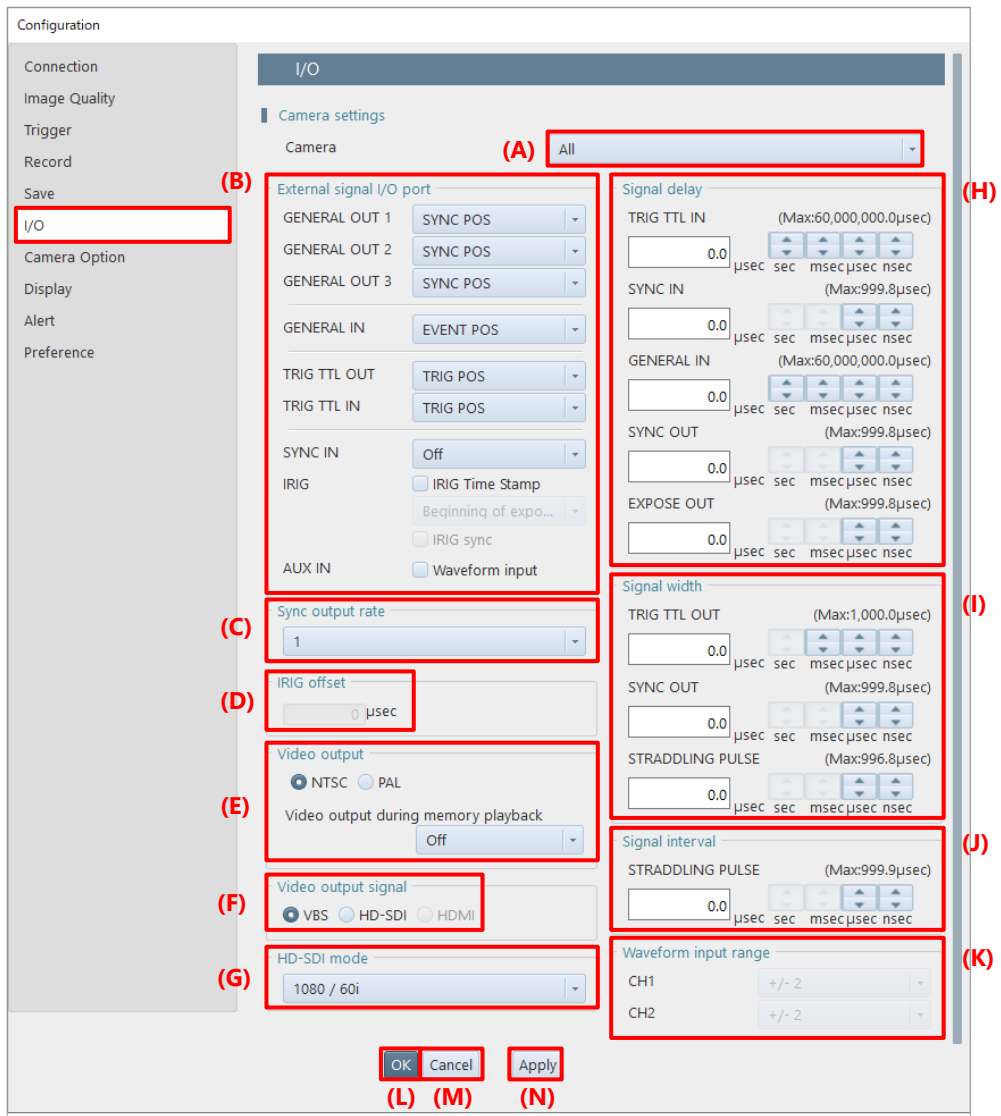

Item	Name	Function
(A)	Camera	Select a camera to set from the list to be displayed by clicking.
(B)	External signal I/O port	In this item, Mini-series cameras and the other cameras are different in contents to be displayed. For setting items in each camera, see “10.6.1 Setting External I/O Port” on page 310.
(C)	Sync output rate	Specify the frequency of a vertical synchronization signal to be output.
(D)	IRIG offset	Specify the IRIG signal offset value in microseconds.



Item	Name	Function
(E)	Video output	Choose NTSC or PAL as a video output format. Moreover, from “Video output during memory playback”, select a video to output to the video monitor.
(F)	Video output signal	<p>Choose VBS, HD-SDI, or HDMI as a video output signal. When HD-SDI is selected, the following can be enabled.</p> <ul style="list-style-type: none"> <li>• Output HDMI</li> <li>• Stop HDMI output when in recording standby</li> <li>• Display OSD</li> <li>• Display a cross cursor</li> </ul> <p> <b>NOTE</b></p> <p>When “Output HDMI” is enabled, the live refresh, save and CFast card save slow down.</p>
(G)	HD-SDI mode	When HD-SDI is selected as a video output signal, select a video signal format.
(H)	Signal delay	<p>Specify the delay times before the following I/O signals are recognized, in seconds, milliseconds, microseconds, and nanoseconds. When specifying the value, be careful not to exceed the displayed limit.</p> <p>Input signal</p> <ul style="list-style-type: none"> <li>• TRIG TTL IN: Signal to be input from the TRIG TTL IN connector</li> <li>• SYNC IN: Signal to be input from the SYNC IN connector</li> <li>• GENERAL IN: Signal to be input from the camera’s external input connector</li> </ul> <p>Output signal</p> <ul style="list-style-type: none"> <li>• SYNC OUT</li> <li>• EXPOSE OUT</li> </ul>
(I)	Signal width	<p>Specify the pulse widths of the following signals, in seconds, milliseconds, microseconds, and nanoseconds. When specifying the value, be careful not to exceed the displayed limit.</p> <ul style="list-style-type: none"> <li>• TRIG TTL OUT</li> <li>• SYNC OUT</li> <li>• STRADDLING PULSE</li> </ul>
(J)	Signal interval	Specify the straddling signal output interval in the width of $\Delta t$ , or in seconds, milliseconds, microseconds, and nanoseconds.
(K)	Waveform input range	<p>Set the input voltage range of the waveform recording built in a camera. Select the range from the list to be displayed by clicking.</p> <p>This item is not displayed for cameras that do not support the waveform input function.</p>
(L)	OK	Applies the settings and closes this screen.
(M)	Cancel	Closes the screen without applying the changed settings.
(N)	Apply	Applies the settings.

## 10.6.1. Setting External I/O Port

Here, the items of “External signal I/O port” on the I/O screen are described. Non-Mini cameras and Mini/Nova/MH6 are different in setting items.

### For Mini CX

(A)	SYNC OUT	SYNC POS
	EXPOSE OUT	EXPOSE POS
	READY OUT	READY POS
(D)	TRIG IN	TRIG POS
(F)	SYNC IN	ON CAM POS
(G)	IRIG	<input type="checkbox"/> IRIG time stamp <input type="checkbox"/> IRIG sync
(I)	REMOTE ON	REMOTE ON POS

### For Non-Mini cameras

External signal I/O port	
(A)	GENERAL OUT 1 SYNC POS
	GENERAL OUT 2 SYNC POS
	GENERAL OUT 3 SYNC POS
(B)	GENERAL IN EVENT POS
(C)	TRIG TTL OUT TRIG POS
(D)	TRIG TTL IN TRIG POS
(F)	SYNC IN Off
(G)	IRIG <input checked="" type="checkbox"/> IRIG time stamp Beginning of expo... <input checked="" type="checkbox"/> IRIG sync
(H)	AUX IN <input type="checkbox"/> Waveform input

### For Mini UX/WX/AX, Nova, Mini R5

(A)	OUTPUT 1 SYNC POS
	<input type="checkbox"/> Output SYNC and EXPOSE only during Ready and Rec states
	OUTPUT 2 TRIG POS
	<input checked="" type="checkbox"/> Output SYNC and EXPOSE only during Ready and Rec states
(B)	INPUT 1 SYNC POS
	INPUT 2 TRIG POS
(E)	TRIG SW IN NORMALLY CLOSE
(F)	External Sync Off
	<input type="checkbox"/> Operates independently when the external sync signal is interrupted
(G)	IRIG <input type="checkbox"/> IRIG time stamp Beginning of expo... <input type="checkbox"/> IRIG sync

### For MH6

(A)	GENERAL OUT 1 SYNC POS
	GENERAL OUT 2 SYNC POS
	GENERAL OUT 3 SYNC POS
(B)	GENERAL IN EVENT POS
(C)	TRIG TTL OUT TRIG POS
(D)	TRIG TTL IN TRIG POS
(E)	TRIG SW IN NORMALLY OPEN
(F)	SYNC IN Off
(G)	IRIG data <input type="checkbox"/> IRIG time stamp Beginning of expo...

※ Only when using Nova, displays “Output SYNC and EXPOSE only during Ready and Rec states”.

※ Only when using Nova S20, Nova R5/R3, and Mini R5, displays “Operates independently when the external sync signal is interrupted”.

※ Only when using Nova and MH6, displays “TRIG SW IN”.

Item	Name				Function
	Mini CX	Mini UX/WX/AX, Nova, Mini R5	Non-Mini	MH6	
(A)	SYNC OUT EXPOSE OUT READY OUT	OUTPUT 1 to 2	GENERAL OUT 1 to 3	GENERAL OUT 1 to 3	Select the type and polarity of the signal to be output from the camera's external output connector. If "Output SYNC and EXPOSE only during Ready and Rec states" is displayed, check this to output SYNC and EXPOSE when the camera is in Ready or Rec status.
(B)	–	INPUT 1 to 2	GENERAL IN	GENERAL IN	Select the type and polarity of the signal to be input from the camera's external input connector.
(C)	–	–	TRIG TTL OUT	TRIG TTL OUT	Select the type and polarity of the signal to be output from the TRIG TTL OUT connector.
(D)	TRIG IN	–	TRIG TTL IN	TRIG TTL IN	Select the type and polarity of the signal to be input from the TRIG TTL IN connector.
(E)	–	TRIG SW IN	–	TRIG SW IN	Select the type and polarity of the signal to be input from the TRIG SW IN connector.
(F)	SYNC IN	External Sync	SYNC IN	SYNC IN	Select the type and polarity of the signal to be input from the SYNC IN connector. If "Operates independently when the external sync signal is interrupted" is displayed check this to allow the camera to continue recording at the set frame rate even when the external sync signal is interrupted.
(G)	IRIG	IRIG	IRIG	IRIG	To make the setting of IRIG time code reception, check "IRIG time stamp". For non-Mini cameras, select a timing from the list when to acquire the time code. To enable synchronization with the IRIG time code, check "IRIG sync".
(H)	–	–	AUX IN	–	Check "Waveform input" to use the waveform recording function incorporated in a camera.
(I)	REMOTE ON	–	–	–	Select the type and polarity of the signal to be input from the RemoteOn connector of a camera.

**NOTE**

- When the [IRIG sync] in the item (G) is checked, the values in the list for normal frame rate become unselectable, after checking [IRIG sync], make variable settings. Only a frame rate and a resolution are selectable that leave a margin adding to the normal variable setting.  
However, in the case of Mini CX, IRIG synchronization can be performed without the variable setting.
- In the case of Mini CX, SYNC IN and [IRIG sync] are linked.

Items to be displayed on the lists (A) to (F), and (I) are as follows.

Item	Name	List Item	Function
(A)	GENERAL OUT1 to 3 OUTPUT1 to 2 SYNC OUT EXPOSE OUT READY OUT	SYNC POS	Outputs a vertical synchronization signal. (positive polarity)
		SYNC NEG	Outputs a vertical synchronization signal. (negative polarity)
		EXPOSE POS	Outputs the camera's exposure interval signal. (positive polarity)
		EXPOSE HEAD1 to n POS	Outputs the camera head 1's to n's exposure interval signal. (positive polarity)
		EXPOSE NEG	Outputs the camera's exposure interval signal. (negative polarity)
		EXPOSE HEAD1 to n NEG	Outputs the camera head 1's to n's exposure interval signal. (negative polarity)
		REC POS	Outputs an interval signal during recording. (positive polarity)
		REC NEG	Outputs an interval signal during recording. (negative polarity)
		TRIG POS	Outputs the trigger signal received by the camera. (positive polarity)
		TRIG NEG	Outputs the trigger signal received by the camera. (negative polarity)
		READY POS	Outputs a signal to indicate the recording ready state. (positive polarity)
		READY NEG	Outputs a signal to indicate the recording ready state. (negative polarity)
		IRIG RESET POS	Outputs the camera's internal IRIG reset signal. (positive polarity)
IRIG RESET NEG	Outputs the camera's internal IRIG reset signal. (negative polarity)		

Item	Name	List Item	Function
(B)	GENERAL IN INPUT1 to 2	EVENT POS	Inputs an event signal (event marker/Two-Stage trigger vary speed). (positive polarity)
		EVENT NEG	Inputs an event signal (event marker/Two-Stage trigger vary speed). (negative polarity)
		TRIG POS	Inputs a TTL trigger signal. (positive polarity)
		TRIG NEG	Inputs a TTL trigger signal. (negative polarity)
		READY POS	Inputs a recording ready state switch signal (READY ON/OFF). (positive polarity)
		READY NEG	Inputs a recording ready state switch signal (READY ON/OFF). (negative polarity)
(C)	TRIG TTL OUT	TRIG POS	Outputs the trigger signal received by the camera. (positive polarity)
		TRIG NEG	Outputs the trigger signal received by the camera. (negative polarity)
		TTL IN THRU POS	Performs TRIG TTL IN through output. (positive polarity)
		TTL IN THRU NEG	Performs TRIG TTL IN through output. (negative polarity)
(D)	TRIG TTL IN, TRIG IN	TRIG POS	Inputs a TTL trigger signal. (positive polarity)
		TRIG NEG	Inputs a TTL trigger signal. (negative polarity)
(E)	TRIG SW IN	NORMALLY OPEN	A trigger can be input as short-circuited. (positive polarity)
		NORMALLY CLOSE	A trigger can be input as the short-circuit is released. (negative polarity)
(F)	SYNC IN External Sync	OFF	Turns OFF external synchronization.
		ON CAM POS (for Non-Mini cameras) ON CAM (for Mini cameras)	Conducts synchronization with a camera of the same type. (positive polarity)
		ON CAM NEG	Conducts synchronization with a camera of the same type. (negative polarity)
		ON OTHERS POS (for Non-Mini cameras) ON OTHERS (for Mini cameras)	Conducts synchronization with an external device (including other Photron products). (positive polarity)
		ON OTHERS NEG	Conducts synchronization with an external device (including other Photron products). (negative polarity)
(I)	REMOTE ON	REMOTE ON POS	Turns on a camera by inputting a TTL signal. (positive polarity)

## 10.6.2. Signal Delay

Specify the delay times before the following I/O signals are recognized, in seconds, milliseconds, microseconds, and nanoseconds. When specifying the value, be careful not to exceed the displayed limit.

### Input signal

- TRIG TTL IN : Signal to be input from the TRIG TTL IN connector
- SYNC IN : Signal to be input from the SYNC IN connector
- GENERAL IN: Signal to be input from the camera's external input connector

### Output signal

- Vertical synchronization signal output
- Exposure interval signal output

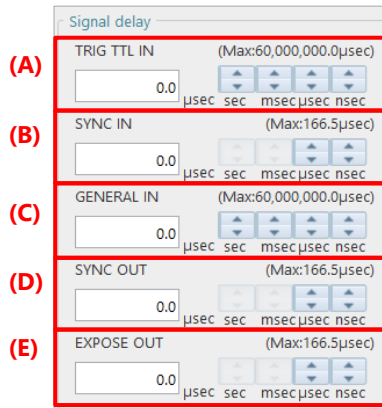

Item	Name	Function
(A)	TRIG TTL IN	Set the delay time before a signal input to the TRIG TTL IN connector is recognized, in seconds, milliseconds, microseconds, and nanoseconds. When setting the value, be careful not to exceed the limit.
(B)	SYNC IN	Set the delay time before a signal input to the SYNC IN connector is recognized, in milliseconds, microseconds, and nanoseconds. When setting the value, be careful not to exceed the limit.
(C)	GENERAL IN	Set the delay time before a signal input to the GENERAL IN connector is recognized, in seconds, milliseconds, microseconds, and nanoseconds. When setting the value, be careful not to exceed the limit.
(D)	SYNC OUT	Set the delay time before a vertical synchronization signal is output, in milliseconds, microseconds, and nanoseconds. When setting the value, be careful not to exceed the limit.
(E)	EXPOSE OUT	Set the delay time before an exposure interval signal to output is output, in milliseconds, microseconds, and nanoseconds. When setting the value, be careful not to exceed the limit.

## 10.6.3. Signal Width

Specify the pulse widths of the following signals, in seconds, milliseconds, microseconds, and nanoseconds. When specifying the value, be careful not to exceed the displayed limit.

- TRIG TTL OUT
- SYNC OUT
- STRADDLING\_WIDTH

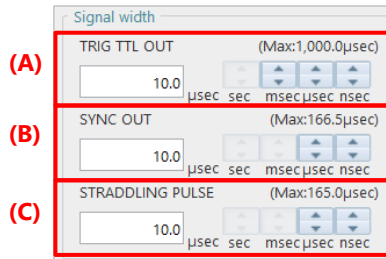

Item	Name	Function
(A)	TRIG TTL OUT	Set the pulse width of a TTL trigger to output, in milliseconds, microseconds, and nanoseconds. When setting the value, be careful not to exceed the limit.
(B)	SYNC OUT	Set the pulse width of a vertical synchronization signal output to output, in milliseconds, microseconds, and nanoseconds. When setting the value, be careful not to exceed the limit.
(C)	STRADDLING WIDTH	Set the pulse width of a straddling signal output to output, in seconds, milliseconds, microseconds, and nanoseconds. When setting the value, be careful not to exceed the limit.

# 10.7. Camera Option Settings

This screen allows you to select a camera and adjust its options. The selectable modes (items shown) vary depending on the model. For details, contact our technical personnel.



Item	Name	Function
(A)	Camera	Select a camera to set from the list to be displayed by clicking.
(B)	Frame rate mode	Set the frame rate. Checking “High quality mode” will improve image quality by controlling the frame rate that can be set. For items other than “High quality mode”, selectable modes (items to be displayed) vary with the camera’s functions. Here, the full-resolution frame rate is set. For example, checking “20KMode” will establish the 20K mode when the camera is restarted; accordingly, the items selectable from the “Frame rate” list in [LIVE] will be changed.



Item	Name	Function
(C)	Low Shutter Speed Function	Checking “Enable” adds “5/10/20/30 fps” to the list of frame rate, and thus allows to choose from among the low shutter speed. <ul style="list-style-type: none"> <li>Mini AX/WX/UX: Allows to select a low shutter speed such as “5 fps”.</li> <li>Nova: The shutter speed limitation (1 ms) is removed.</li> </ul>
(D)	Operation Bit Switching	If you select the “8bit” option while using a camera with a 12-bit sensor, upper eight bits of the sensor can be used for recording. Selecting this option reduces the data size and increases the available memory, so the recording time can be longer. Nova S20 allows switching between 10-bit and 12-bit. It is also possible to select the bit position (Higher, Middle, or Lower).
(E)	Auto playback	Select the camera’s operation mode after shooting is finished.
(F)	EXPOSE signal extension	Checking “Enable” enables the exposure instability period prior to the falling edge of the EXPOSE POS signal.
(G)	Dual slope shutter	Checking “Enable” enables the dual slope shutter function on Nova R3 / R5. For details of the dual slope shutter, refer to the “4.3.4 Detailed Settings of Shutter Speed” on page 68.
(H)	Camera date and time	Set the camera’s date and time in “Date” and “Time” respectively. Clicking the [Set with PC] button imports the PC’s date and time. Clicking the [Apply] button reflects a freely specified date and time in the camera.
(I)	USER SW	Assign the functions selected in [USER] to programmable switches in the camera.
(J)	Allocating free memory to active channel	Check here to allocate free memory for unconnected camera heads to connected heads.
(K)	Automatically turn on camera	Checking this automatically turns on the camera when the external power is supplied.
(L)	Automatically start saving to CFast card	Checking this automatically starts to save data to CFast card when a CFast card is inserted.
(M)	Stop fan while waiting trigger and recording	Checking this turns off the fan during the trigger wait time or recording.
(N)	Restore factory default settings	Checking this resets the camera settings to the factory default settings.
(O)	OK	Applies the settings and closes this screen.
(P)	Cancel	Closes the screen without applying the changed settings.
(Q)	Apply	Applies the settings.

## NOTE

- Beware that the image quality lowers when the low shutter speed is chosen.
- The shutter speed of 1/frame and 1/50sec or more can be chosen if the Low Shutter Speed Function is enabled.
- The slowest shutter speed when the low light mode is used is 1/50sec.
- Low shutter speed cannot be chosen in “Variable” setting.
- The shutter speed is limited to 1 msec on AX. This limitation is removed when the Low Shutter Speed Function is enabled.
- “Automatically start saving to CFast card” function is not available when “Enable hardware auto save” is checked in [MENU] - [Configuration] - [Save].  
For details, see the “10.5 Save Settings” on page 306.

# 10.8. Display Settings

This screen allows the settings about the screen display when PFV is started.

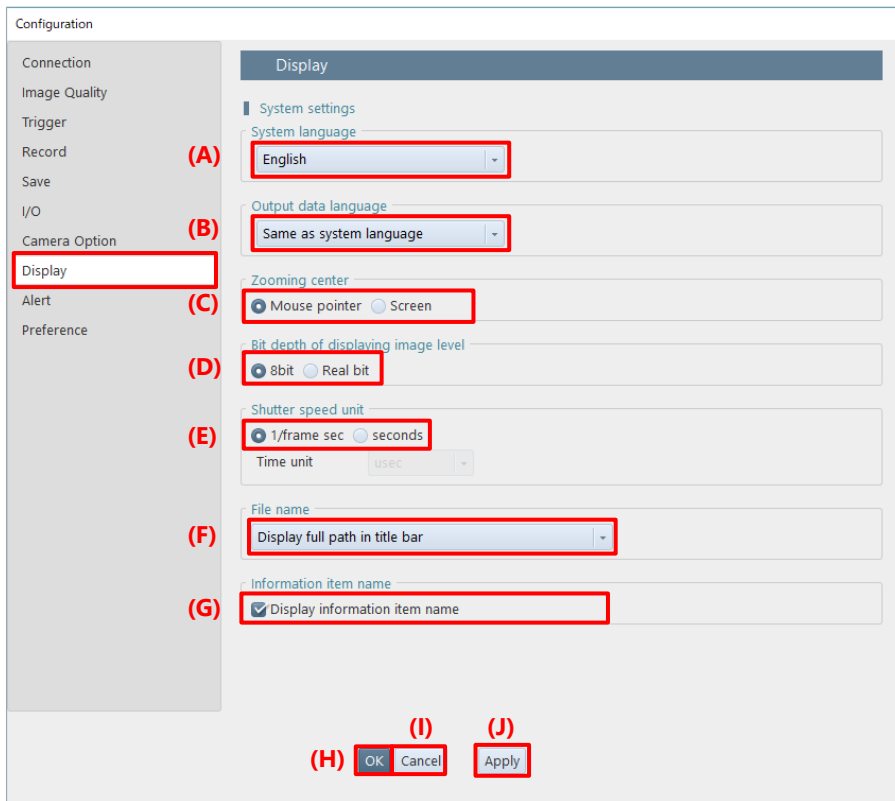

Item	Name	Function
(A)	Language	Select a language to use on PFV from the list to be displayed by clicking.
(B)	Output Language Setting	Select a language of a file to be saved by PFV.
(C)	Zooming center	Select a scaling center position from the following. Screen: Enlarges from the screen center. Mouse pointer: Enlarges from the clicked position.
(D)	Bit depth of displaying image level	Choose “8bit” or “Real bit” as the gradation of cross cursors.
(E)	Shutter speed unit	Choose “1/frame sec” or “seconds” as the unit of shutter speed.
(F)	File name	Select a character string to be displayed on the title bar when opening a file, from the list to be displayed by clicking.
(G)	Information item name	Check here to display information item names in the pane.
(H)	OK	Applies the settings and closes this screen.
(I)	Cancel	Closes the screen without applying the changed settings.
(J)	Apply	Applies the settings.

## 10.9. Alert Settings

This screen allows the settings about confirmation and alert displays.  
To display a confirmation or an alert, check the corresponding item.

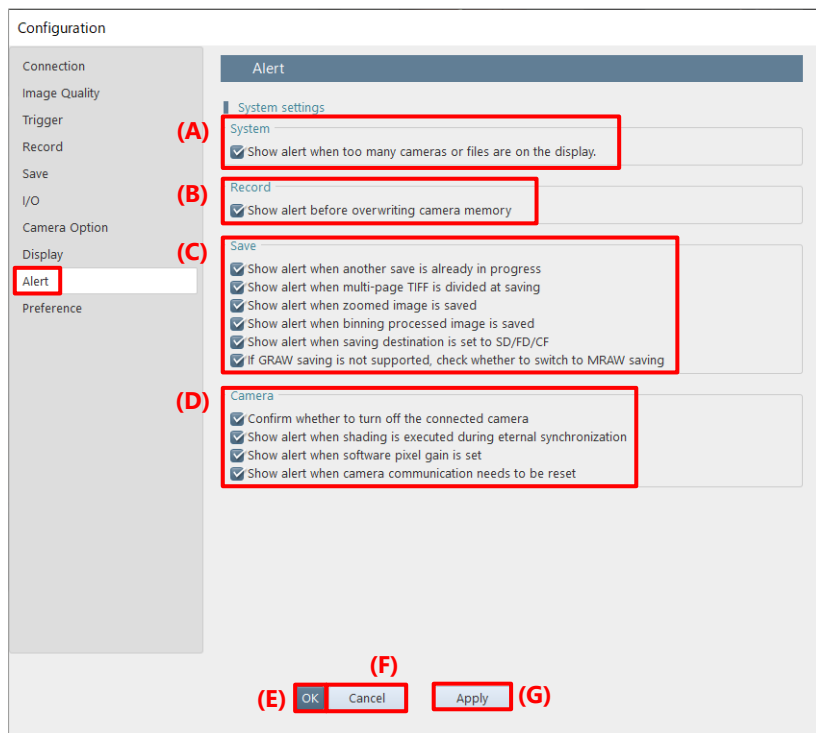

Item	Name		Function
(A)	System	Show alert when too many cameras or files are on the display.	Alerts when too many cameras or files are on the display.
(B)	Record	Show alert before overwriting camera memory	Alerts when the [Record] button is clicked in using endless triggers (center, end, manual, and random manual).
(C)	Save	Show alert when another save is already in progress	Alerts when recording cannot be started because data is being saved to the current partition.
		Show alert when multi-page TIFF is divided at saving	Alerts when data is split up and saved in Multi-page TIFF format.
		Show alert when zoomed image is saved	Alerts when data is resized and saved.
		Show alert when binning processed image is saved	Alerts when data is saved by binning.
		Show alert when saving destination is set to SD/FD/CF	Alerts when saving destination is SD card / FAST Drive / CFast card in trimmed duration save mode.
		if GRAW saving is not supported, check whether to switch MRAW saving	Shows message if GRAW saving is not supported and switches to MRAW saving.

Item	Name		Function
(D)	Camera	Confirm whether to turn off the connected camera	Displays a message asking if you want to turn off the connected camera when exiting PFV4.
		Show alert when shading is executed during external synchronization	Alerts when performing shading during external synchronization.
		Show alert when software pixel gain is set	Alerts when saving destination is SD card / FAST Drive / CFast card while software pixel gain is enabled.
(E)	OK		Applies the settings and closes this screen.
(F)	Cancel		Closes the screen without applying the changed settings.
(G)	Apply		Applies the settings.

# 10.10. Preference

This screen describes other customizable settings.

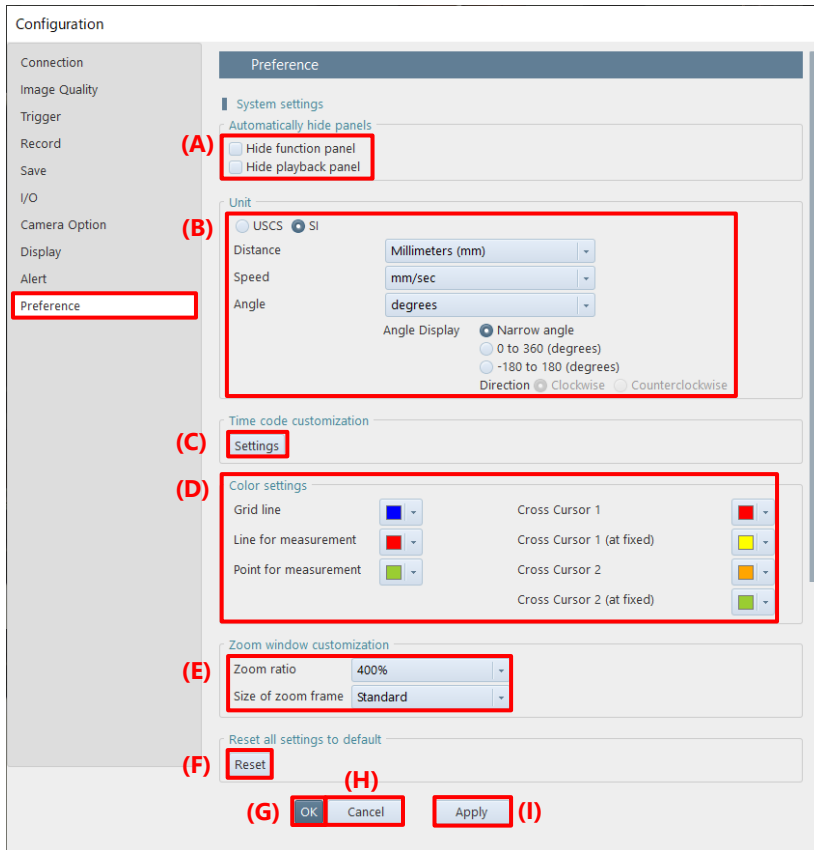

Item	Name	Function
(A)	Automatically hide panels	Check these options to hide the function panel or the playback panel automatically.
(B)	Unit	Choose the USCS (United States Customary System) or the SI (International System) units to use in the setting/display of measurement and correction. Moreover, select the units of distance, speed, and angle to use, from the corresponding list displayed by clicking. <ul style="list-style-type: none"> <li>• Narrow angle: Displays the angle from 0 to 180 degrees. If the angle exceeds 180 degrees, the narrower angle is displayed.</li> <li>• 0 to 360 (degrees): Displays the angle from 0 to 360 degrees.</li> <li>• -180 to 180 (degrees): If the angle exceeds 180 degrees, the angle minus 360 will be displayed. e.g. If the angle is 260 degrees, displays as -100 degrees (260 - 360).</li> <li>• Direction: Select clockwise or counterclockwise.</li> </ul>
(C)	Time code customization	Click [Settings] to make the settings about time code display on the [Time Code Display Settings] screen. For details, see “10.10.1 Time Code Display Settings” on page 322.
(D)	Color settings	Select the colors of grid lines, simple measurement lines and points, and cross cursors, from the corresponding palette displayed by clicking [▼]. The colors of the 1st and 2nd cross cursors can be specified for those during edit and when fixed.

Item	Name	Function
(E)	Zoom window customization	Make the settings about the size and zoom ratio of a cursor “+” that is displayed during manual tracking or Keystone correction. Select the desired size and zoom ratio from the lists displayed by clicking “Zoom ratio” and “Size of zoom frame”.
(F)	Reset all settings to default	Clicking the [Reset] button returns all settings to the default settings.
(G)	OK	Applies the settings and closes this screen.
(H)	Cancel	Closes the screen without applying the changed settings.
(I)	Apply	Applies the settings.

## 10.10.1. Time Code Display Settings

To display the time code display setting screen, click the [Settings] button at the time code display setting field. This screen allows the settings about time code display.

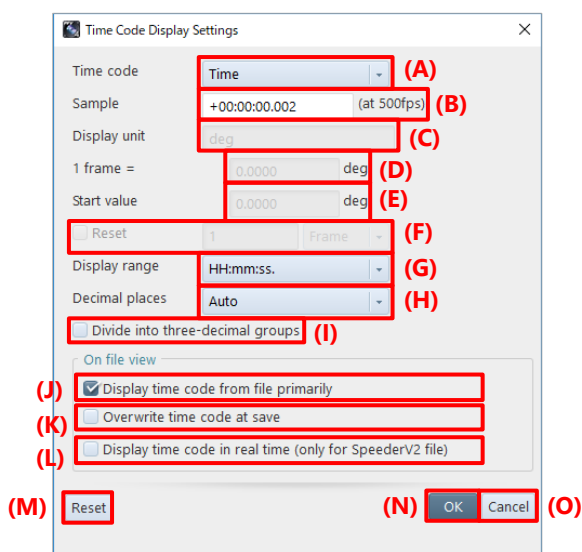

Item	Name	Function
(A)	Time code	The default is “Time”. To freely set a time code, choose “User settings”.
(B)	Sample	Specify a sample.
(C)	Display unit	Enter the unit of time code. It can be set when “User settings” is selected in “Time code”.
(D)	1 frame =	Enter the length of 1 frame in the unit displayed. It can be set when “User settings” is selected in “Time code”.
(E)	Start value	Specify a start value. It can be set when “User settings” is selected in “Time code”.
(F)	Reset	Choose this to reset the time code to 0 with a freely specified value. Check the check box and enter the frame value to reset in the box to the right. It can be set when “User settings” is selected in “Time code”.
(G)	Display range	Select a time display format. It can be set when “Time” is selected in “Time code”.

Item	Name	Function
(H)	Decimal places	Specify the number of decimal places. The default is “Auto”, which will change the number of digits according to the frame rate. The number of digits can be set freely when “Time” is selected in “Time code”.
(I)	Divide into three-decimal groups	A space is inserted every three decimal places. The default is “OFF”. It can be set when “Time” is selected in “Time code”.
(J)	Display time code from file primarily	Checking this will give priority to the time code display setting saved in the information file.
(K)	Overwrite time code at save	Checking this will save the current time code display setting to the information file at the time of resave in FILE mode.
(L)	Display time code in real time (only for SpeederV2 file)	Checking this will display the time code in real time when a SpeederV2 file is played back.
(M)	Reset	Returns the settings to default.
(N)	OK	Applies the settings and closes this screen.
(O)	Cancel	Closes the screen without applying the changed settings.

# A

**A. Appendix**



# A1. FAQ and Troubleshooting

## Q1. PFV shows no live image from a camera.

### If the network LED (IF LINK/TRANS, GbE, or GIGABIT ETHERNET) is not lit

- The possible cause is a poor connection of the network cable or a failure in the LAN port on the PC.
- Initialize the IP address of the camera. Try the following operations for your camera.  
For the details of the procedure, refer to the hardware manual of each model.

Camera	IP address Reset Operation
SA series, MH6	Press and hold USER1 switch for “10 seconds”.
Mini AX/WX/UX, Nova series, Mini R5	Press and hold RESET switch until all the LEDs light up, turn off, blink once, and lights up. Reboot the camera.
Mini CX	Press RESET switch once.

### If the network LED is lit

- There is a possibility that IP address and firewall settings on the PC are not made.  
Check the communication by using the command prompt.

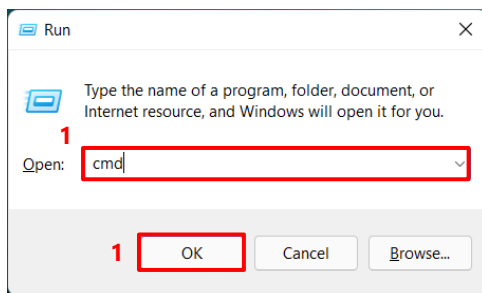

1. Press the [Win] key and [R] key, enter “cmd” and click the [OK] button to open the Command Prompt.

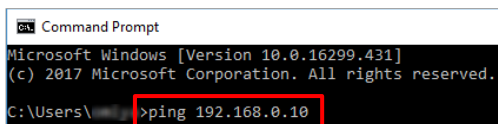

2. On the command prompt, type in “ping 192.168.0.10” (camera’s IP address) and press the [Enter] key.

This is a display for normal connection.  
Communication between the camera and the PC is established.

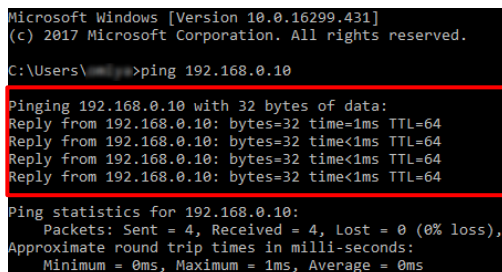

This is a display for abnormal communication.  
There is a high possibility that settings on the PC are not made.

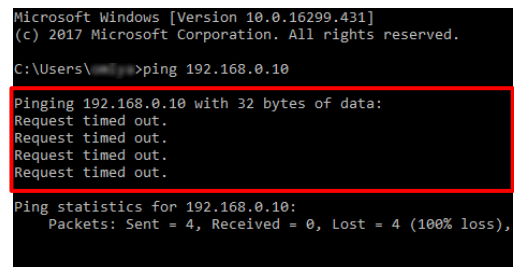

- If you are unable to connect the camera, initialize the camera to the factory defaults. Try the following operations for your camera.  
For the details of the procedure, refer to the hardware manual of each model.

Camera	Factory Initialization Operation
SA series, MH6	Press and hold USER1 switch for more than “15 seconds”.
Mini AX/WX/UX, Nova series, Mini R5	Press and hold RESET switch until all the LEDs light up, turn off, blink once, and light up repeatedly for “3 sets”. Reboot the camera.
Mini CX	Press RESET switch for more than “4 seconds” while the camera is turned off.

## Q2. Will a camera retain shooting data when being turned off?

- Data will be lost when the camera is turned off. Be sure to download necessary data after shooting.



**Reference:** “6.2 Saving Recorded Data” on page 113

## Q3. Data download is very slow.

- Check the size of downloaded data. It may be slow depending on the sequential number format and compression codec for image files. Deterioration in the LAN cable may also slow it down.



**Reference:** “6.2.5 Edit File Name” on page 118  
“6.2.9 File Formats and Options” on page 126

## Q4. A camera makes no response even if being turned on, and LEDs on its back will not light up normally.

- Try to check for a problem with the power supply. If there is no problem, take a moment to contact Photron or the dealer.



**Reference:** “A5 Contacting Photron” on page 341

## Q5. Whole or part of video is streaked.

- Check whether a shading correction is made.  
If the problem persists, take a moment to contact Photron or the dealer because there is a possibility of an internal failure.



**Reference:** “4.3.7 Shading Calibration” on page 76

## Q6. Tone of video is unusual.

- Try to turn off the software pixel gain.
- Try to adjust the color temperature.

 **Reference:** “10.2 Image Quality Settings” on page 299  
“8.1.2 Color Adjustment” on page 177

## Q7. A screen has dotted noise.

- Try to perform the shading correction function.

 **Reference:** “4.3.7 Shading Calibration” on page 76

## Q8. How to initialize a camera to the factory default.

- Depending on the model, PFV can reset the camera to factory default.
  1. Click [MENU] - [Camera Option]. Check the “Restore factory default settings” checkbox.
  2. Check the confirmation message and click the [Yes] button.
  3. Click the [OK] button.
  4. Wait for about 20 seconds, then turn off the camera and reboot.

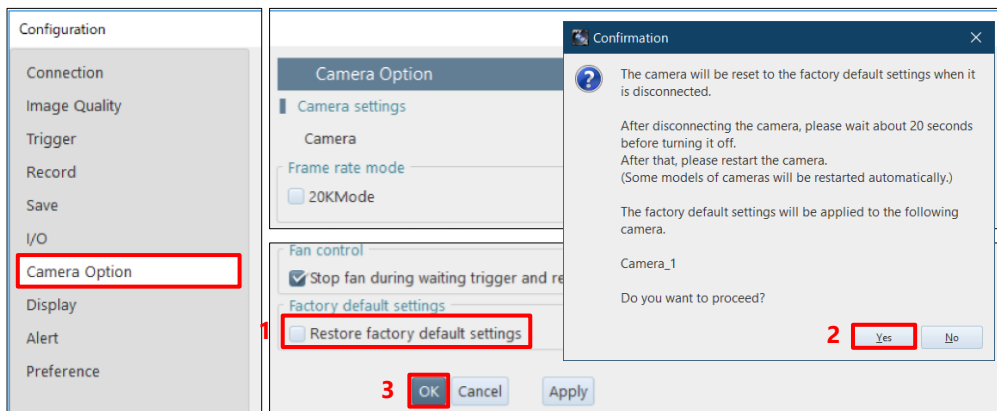

- You can also reset the camera to factory default from the switch on the camera. Try the following operations for your camera. For the details of the procedure, refer to the hardware manual of each model.

Camera	Factory Initialization Operation
SA series, MH6	Press and hold USER1 switch for more than “15 seconds”.
Mini AX/WX/UX, Nova series, Mini R5	Press and hold RESET switch until all the LEDs light up, turn off, blink once, and light up repeatedly for “3 sets”. Reboot the camera.
Mini CX	Press RESET switch for more than “4 seconds” while the camera is turned off.

Q9. A message asking whether to delete data is displayed when attempting to change the shooting conditions while using a Mini CX camera.

---

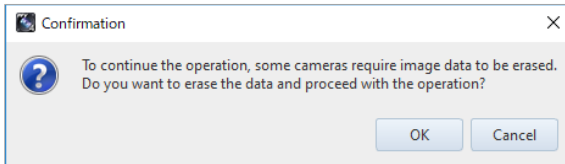

- If you want to change the frame rate, shutter speed, resolution, trigger mode, low light, SYNC IN, and IRIG setting or load a PCSX file, Mini CX camera needs to erase the recording data on the camera memory. Therefore, if necessary, save the recording data in a PC or dedicated nonvolatile medium before changing the conditions.

Q10. A confirmation message for the camera communication reset while using ST Camera Head.

---

- The warning is displayed when there is a sudden temperature change in the camera head or relay box. Clicking the [Reset] button in the “Camera communication reset” of the function panel will execute phase adjustment (camera communication reset) for all selected cameras for which a phase adjustment warning has occurred.  
If a phase error occurs due to a sudden temperature change of the camera, the data transfer may be abnormal depending on the model. When the warning appears, click the [Reset] button in the “Camera communication reset”.

Q11. Connecting a camera using 10GbE, but the speed is not high.

---

- Use a commercially available 10GBASE-T compatible interface board and a CAT7 (Category 7) or higher STP cable.
- Make sure that the PC’s network card and hub are compatible with 10GBASE-T.  
If you connect the camera to a network card that does not support 10GBASE-T via a hub that supports 10GBASE-T, the PC will not be able to receive commands from the camera and the camera will freeze and will not operate properly.  
Use a network card that supports 10GBASE-T.
- Check the packet interval mode setting. If it is set to “Normal (1Gbps equivalent)”, the speed will be the same as that of a 1GbE connection. For the setting procedure, see the “3.1.4 Optimizing Ethernet Settings”.
- You may need to change the power settings of your PC and the settings of the network card. See the “Gigabit Ethernet I/F Camera Connection Manual” for details.

## Q12. Every time I add a camera or open a file, a warning appears.

---

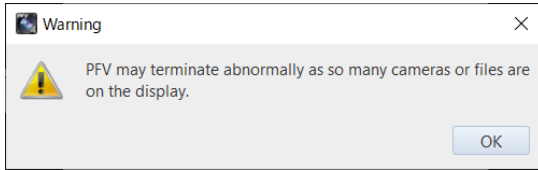

- The above warning may be displayed even though the image is being rendered correctly. This is especially likely to occur when using multiple cameras with high resolution such as Nova R5 (4K camera).
- If the warning message appears even though the image is being rendered normally, you can hide it by unchecking the “Show alert when too many cameras or files are on the display.” checkbox in the [System settings] field of [MENU] - [Configuration] - [Alert].



**Reference:** “10.9 Alert Settings” on page 319

If you have any other questions, cannot solve a problem, or encounter any other abnormalities, take a moment to contact Photron or the dealer.

## A2. Terms

Here, the terms used in this manual are described.

Term	Description
ADC file	In the FastCam series where an analog signal can be input, this is a data format where the analog signal is recorded.
CIH file	Camera information file used in Version 3 or earlier = CIH (Camera Information Header) file. Text file that contains information about the moving image data shot with a Photron high-speed camera and set values and shooting conditions of a camera device during shooting.
E-Sync	Abbreviation for External Sync. When the camera is driven by external sync, (E-Sync) is displayed on the right side of the frame rate.
Event marker	The camera has a function to memorize a frame number the instant you enter the signal from outside during recording, allowing you to jump to the memorized frame number (event frame) during playback. This is the marker of this memorized frame number. By marking a point in time that you are interested in besides a trigger point, you can easily call the video at that point in time during playback.
Layout save	This is a method to make a composite video from those shot with multiple cameras and heads and then save the file.
Line profile	This is a graph showing changes in light intensity on one line.
Low light	This lightens a LIVE mode display screen by reducing the frame rate temporarily. It is useful for such a case where, because of high-speed image shooting, the LIVE mode display screen is so dark until shooting is executed that the lens focus cannot be adjusted easily, under the set shooting conditions.
LUT	This stands for LookUp Table. It is a list that contains other values to output in response to input values.
PIV	This stands for Particle Image Velocimetry. This is a method to measure the distribution of the velocity of fluid itself by putting microparticles that moves at the same speed as the fluid into the flow and measuring the velocity of the particle utilizing the image measurement method.
Pixel gain	This enables independent gain adjustment for all the sensor pixels. The setting becomes effective on PFV only. It is not reflected in the camera. Making both the shading correction and the pixel gain correction can eliminate the non-uniformity in pixels attributed to the camera's lighting conditions, optical system, or image sensor. This correction is not reflected in the NTSC/PAL video monitor output.
Shading	This is, in an image processor, an inconsistency in the conversion characteristics between the original brightness of a target image and the video signal, resulting from the vignetting of camera optical system or the non-uniformity of image sensor sensitivity.
STP cable	This means a shielded LAN cable.
Waveform data	This has stored the data acquired by synchronizing the DAQ function or the camera's analog signal input with shot images.

# A3. Various Information

## A3.1 File Format

Here, the file format available to PFV is described.  
CSV files can be associated with videos and then loaded.

Term	Description
ADC file	In the FastCam series where an analog signal can be input, this is a data format where the analog signal is recorded.
CIH file	Camera information file used in Version 3 or earlier = CIH (Camera Information Header) file. Text file that contains information about the moving image data shot with a Photron high-speed camera and set values and shooting conditions of a camera device during shooting.
CIHX file	This is an archive that contains camera information, waveform information, and IRIG information. The file contains information about the moving image data shot with a Photron high-speed camera and set values and shooting conditions of a camera device during shooting. It is generated in the folder to store image files during file save to the PC. For details of the information to be saved, see “A3.2 Various Information in CIHX File” on page 333. (The CIH file in older versions is a file that has stored the similar information in text format. This version can only load it.)
CSV Type A	This is one of the data formats of the CSV file that has recorded waveform data. Data can only be read from PFV.
CSV Type B	This is one of the data formats of the CSV file that has recorded waveform data. Data can only be read from PFV.
CSV Type C	This is one of the data formats of the CSV file that has recorded waveform data. Data can only be read from PFV.
CSV Type D	This is one of the data formats of the CSV file that has recorded waveform data. Data can only be read from PFV.
CSV Type S	This is one of the data formats of the CSV file that has recorded waveform data. Data can be read from and written to PFV.
TypeAwithT	This is one of the data formats of the CSV file that has recorded waveform data. Data can be read from and written to PFV.
TypeBwithT	This is one of the data formats of the CSV file that has recorded waveform data. Data can be read from and written to PFV.
CSV (line profile information)	This is a file to be generated when data is output in CSV format in the line profile plug-in.
CSV (histogram)	This is a file to be generated when data is output in CSV format in the histogram plug-in.
GDF file	This stands for Gain Data File, which can store pixel gain data. The data is binary, and all the data are saved in unsigned short type.
INF file	This is a file in which information such as an image is described.

Term	Description
IRG file	This is an IRIG time code to be output during file save when IRIG input is used on PFV. It is binary data that consists of 20 bytes per frame.
ISO-MME file	This is a multimedia data exchange format (Road vehicles - Multimedia data exchange format for impact test) file for vehicle impact test defined in ISO/TS 13499. The file is in text format.
MCD file	This is a binary file that has recorded waveform data. PFV4 can load it.
PCSX file	This means PFV Camera Setup file, where the various information set on PFV4 is output in XML format. This file allows the compound data of document files and application setting files to be saved to the PC when a user clicks the pcsx file save button. When the saved pcsx file is loaded, all the saved settings will be applied. Double-clicking the pcsx file will start PFV with the settings that were in place when the pcsx file was created.
TEMA format	This is a data format that is edited so that waveform data can be loaded by the external application "TEMA".
WVDX file	This is a binary file that has recorded waveform data. PFV4 can both write and load it.



## A3.2 Various Information in CIHX File

Information to be stored in the CIHX file is as follows.

- CIHX Version
- Creation Date
- Creation Time
- PFV Version
- PDC Version
- Serial number digits of sequentially numbered image files
- Image file format
- Image resolution
- Segmentation CIHX
- Related CIHX
- Groups
- Image color type
- Sensor bit depth, bit position
- Apply image processing
- Pixel position information relative to full camera resolution
- Data number for external media resave
- Serial number for external media resave
- Total number of frames recorded
- Total number of frames saved to file
- Start frame number
- Virtual trigger (ON/OFF)
- Virtual trigger frames
- Skip saved frames
- Event trigger number
- RecOnCmd Difference from previous trigger frame
- Comment text
- Logo file path
- Custom information
- Camera name
- Date of recording (SpeederV2 only)
- Recording time (SpeederV2 only)
- Trigger time (SpeederV2 only)
- Frame rate
- Shutter speed (s)
- Shutter speed (ns)
- Trigger mode
- Number of frames set after trigger
- Number of random trigger settings
- Number of random trigger times
- Time from trigger to start of exposure
- Number of trigger disable times
- Time code (type)
- Time code (display unit)
- Time code (frame unit)
- Time code (start value)
- timecode (reset unit)
- Time code (reset ON/OFF)
- Time code (decimal places)
- Time code (maximum display range)
- Time code (decimal point separated by every 3 digits or not)
- Automatic exposure (ON/OFF)
- Temperature at start of recording
- Acceleration at start of recording
- Camera mode
- Device IP address
- Device Subnet Mask
- Device Gateway
- Device firmware version
- Device Code
- Device Name
- Head Name
- Head Number
- Head Type
- IRIG timestamp
- IRIG Synchronization
- Slow frame rate setting
- Resolution
- Variable channel
- Number of partitions
- Current partition
- Resolution lock
- Shutter speed lock
- Dual slope shutter mode
- Auto Exposure (ON/OFF)
- Auto Exposure setpoint
- Pixel gain mode
- Mechanical shutter enable/disable setting
- Hardware recording type
- SD card recording mode
- Partition increment mode
- Hardware auto data save mode
- External sync signal output magnification
- IRIG offset
- IRIG sample timing
- Video output during memory playback
- Video signal (VBS/HD-SDI)
- HDMI output for HDMI output
- OSD display
- Crosshairs display
- ADC (ON/OFF)
- External input (General In)
- External Output (General Out1)
- Delay (GeneralIn)
- Self-drive when external signal is interrupted
- Autoplay
- Indefinite Exposure Period Extension
- Acceleration Trigger Input Control
- Acceleration when accelerometer trigger input
- Acceleration trigger duration
- Trigger mask function enabled
- Trigger signal limit width
- Acceleration trigger duration
- CFast auto save setting when external power supply is interrupted
- CFast insertion setting (CFast auto save)
- Power supply setting
- Temperature when saving CIHX
- Memory share function
- Significant digits with decimal point less than or equal to  $\mu\text{sec}$
- Fan stop while waiting for trigger and recording
- LED status for LED/laser option
- Laser status for LED/laser option
- Color temperature correction
- Color temperature correction factor R component
- color temperature correction factor G component
- color temperature correction factor B component
- Color temperature correction factor Default value
- Color temperature Correction Factor Maximum Value
- Color temperature mode list
- Color enhancement factor matrix Rx elements
- Color enhancement Factor matrix Gx elements
- Color enhancement Factor matrix Bx elements
- Color enhancement correction modes
- Color enhancement correction list
- USER SW
- Partition name
- Lens settings
- Lower and upper limits of save range
- Playback range lower and upper limits
- Repeat playback
- Skip playback
- Skip playback frames
- Skip playback units
- Trigger parameter lock target

# A4. CSV File

Imported wave form data can be exported in a CSV file.

In a CSV file, imported waveform data follows the header part in which the camera shooting conditions are described.

In the imported waveform data part, data can be imported in the Type A, Type B, Type C, or Type D data array format. Also, data can be imported or exported in the TypeAwithT, TypeBwithT, or Type S data array format.

## A4.1 Type A

In Type A, data is listed in sample units.

- Data can only be exported from PFV.
- The columns related to the IRIG time (four columns on the right) may not exist.
- Sloap and Intercept store the applied sampling values.
- There is the Digital column for MCDL. However, PFV ignore this column.
- The keys (character strings starting with #) and the titles of the data part are case sensitive.
- #AnalogBoardType, #AnalogBoardID, and #Sampling/Frame may not exist.

#PHOTRON MCDL DATA									
#SheetType	A								
#Date	2017/1/11								
#Time	18:11:21								
#CameraType	FASTCAM SA5 model 1300K-C1								
#CameraID	12								
#AnalogBoardType	NIDAQ USB-6361 (BNC)								
#AnalogBoardID	1								
#FrameRate(fps)	7000								
#SaveStep	1								
#ShutterSpeed(sec)	1/10000								
#ImageWidth	1024								
#ImageHeight	1024								
#TriggerMode	Center								
#NumberOfFrames	11	11							
#FrameRange	-5 to 5								
#UseZeroFrame	1								
#SamplingRate(sps)	70000								
#Sampling/Frame	10	10							
#NumberOfDats	110	110							
#Sloap			1	1					
#Intercept			0	0					
DataNo	FrameNo	SampleNo	Digital	AnalogA	AnalogB	IRIG_Day	IRIG_Hour	IRIG_Minutes	IRIG_Second
0	-5	0	*	*	*	*	*	*	*
1	-5	1	*	*	*	*	*	*	*
2	-5	2	*	*	*	*	*	*	*
3	-5	3	*	*	*	*	*	*	*
4	-5	4	*	*	*	*	*	*	*

## A4.2 Type B

In Type B, data is listed in shoot image frame units.

- Data can only be exported from PFV.
- In one data column, “channel x number of samplings”, “channel x number of samplings”, ... are listed.
- The columns related to the IRIG time (four columns on the right) may not exist.
- Sloap and Intercept store the applied sampling values.
- There is the Digital column for MCDL. However, PFV ignore this column.
- #AnalogBoardType, #AnalogBoardID, and #Sampling/Frame may not exist.
- The keys (character strings starting with #) and the titles of the data part are case sensitive.

#PHOTRON MCDL DATA												
#SheetType	B											
#Date	2017/1/11											
#Time	18:11:21											
#CameraType	FASTCAM SA5 model 1300K-C1											
#CameraID	0											
#AnalogBoardType	NIDAQ USB-6361 (BNC)											
#AnalogBoardID	1											
#FrameRate(fps)	7000											
#SaveStep	1											
#ShutterSpeed(sec)	1/10000											
#ImageWidth	1024											
#ImageHeight	1024											
#TriggerMode	Center											
#NumberOfFrames	11											
#FrameRange	-5 to 5											
#UseZeroFrame	1											
#SamplingRate(sps)	70000											
#Sampling/Frame	10											
#NumberOfDatas	11	11										
#Sloap					1			1		1		
#Intercept								0		0		
DataNo	FrameNo	Digital-0	...	Digital-9	AnalogA-0	...	AnalogA-9	AnalogB-0	...	AnalogB-9	AnalogC-0	...
0	-5	*		*	*		*	*		*	*	
1	-4	*		*	*		*	*		*	*	
2	-3	*		*	*		*	*		*	*	
3	-2	*		*	*		*	*		*	*	
4	-1	*		*	*		*	*		*	*	

## A4.3 Type C

In Type C, data is listed in sample units.

- Data can only be exported from PFV.
- In a Type C file, Digital data of Type A are divided into 1-bit units. Since Digital data consists of 6 bits, the data is divided into six columns in this file.
- The columns related to the IRIG time (four columns on the right) may not exist.
- Sloap and Intercept store the applied sampling values.
- There is the Digital column for MCDL. However, PFV ignore this column.
- The keys (character strings starting with #) and the titles of the data part are case sensitive.

#PHOTRON MCDL DATA									
#SheetType	C								
#Date	2017/1/11								
#Time	18:11:21								
#CameraType	FASTCAM SA5 model 1300K-C1								
#CameraID	0								
#FrameRate(fps)	7000								
#SaveStep	1								
#ShutterSpeed(sec)	1/10000								
#ImageWidth	1024								
#ImageHeight	1024								
#TriggerMode	Center								
#NumberOfFrames	11	11							
#FrameRange	-5 to 5								
#UseZeroFrame	1								
#SamplingRate(sps)	70000								
#SamplingRate(sps)	110	110							
#Sloap									1
#Intercept									0
DataNo	FrameNo	SampleNo	Digital1	Digital2	Digital3	Digital4	Digital5	Digital6	AnalogA
0	-5	0	*	*	*	*	*	*	*
1	-5	1	*	*	*	*	*	*	*
2	-5	2	*	*	*	*	*	*	*
3	-5	3	*	*	*	*	*	*	*
4	-5	4	*	*	*	*	*	*	*

## A4.4 Type D

In Type D, data is listed in shoot image frame units.

- Data can only be exported from PFV.
- In a Type D file, Digital data of Type B are divided into 1-bit units. Since Digital data consists of 6 bits, the data is divided into six columns in this file.
- The columns related to the IRIG time (four columns on the right) may not exist.
- Sloap and Intercept store the applied sampling values.
- There is the Digital column for MCDL. However, PFV ignore this column.
- #AnalogBoardType, #AnalogBoardID, and #Sampling/Frame may not exist.
- The keys (character strings starting with #) and the titles of the data part are case sensitive.

#PHOTRON MCDL DATA												
#SheetType	D											
#Date	2017/1/11											
#Time	18:11:21											
#CameraType	FASTCAM SA5 model 1300K-C1											
#CameraID	0											
#AnalogBoardType	NIDAQ USB-6361 (BNC)											
#AnalogBoardID	1											
#FrameRate(fps)	7000											
#SaveStep	1											
#ShutterSpeed(sec)	1/10000											
#ImageWidth	1024											
#ImageHeight	1024											
#TriggerMode	Center											
#NumberOfFrames	11											
#FrameRange	-5 to 5											
#UseZeroFrame	1											
#SamplingRate(sps)	70000											
#Sampling/Frame	11											
#NumberOfDatas												
#Sloap												
#Intercept												
DataNo	FrameNo	Digital1-0	...	Digital1-9	Digital2-0	...	Digital2-9	Digital3-0	...	Digital3-9	Digital4-0	...
0	-5	*		*	*		*	*		*	*	
1	-4	*		*	*		*	*		*	*	
2	-3	*		*	*		*	*		*	*	
3	-2	*		*	*		*	*		*	*	
4	-1	*		*	*		*	*		*	*	

## A4.5 Type S

---

This is a simple file consisting of a time axis and sample values.

- Data can be exported from and imported to PFV.
- The first column is a time axis item.
- There are four-time axis units: sec, msec,  $\mu$ sec, and nsec.
- When reading data, the data is read as sampling data of Sloap=1 and Intercept of Y=0.
- Each channel has the Y-axis unit.
- If the frequency is omitted (the Frequency line does not exist), the frequency will be calculated from the difference between the first- and second-time data.
- Frequency, Time, and time axis units are not case sensitive.

Frequency	10000		
Time	CH1	CH2	CH3
msec	V	V	V
-5	*	*	*
-4.9	*	*	*
-4.8	*	*	*

## A4.6 Type A with T

This file is a slightly improved file that includes the time axis items in addition to the items of Type A.

- Data can be exported from and imported to PFV.
- The columns related to the IRIG time (four columns on the right) may not exist.
- The first column is a time axis item.
- There are four-time axis units: sec, msec,  $\mu$ sec, and nsec.
- This file does not have the #UseZeroFrame line of Type A. (PFV always uses 0 frames.)
- Sloap and Intercept store the applied sampling values.
- The keys (character strings starting with #) and the titles of the data part are case sensitive.

msec	DataNo	FrameNo	SampleNo	Dev1/ai0	Dev1/ai1	IRIG_Day	IRIG_Hour	IRIG_Minute	IRIG_Second
-1.25	0	-5	0	-0.083462	0.005483	0	0	4	18.817659
-1.225	1	-5	1	-0.066059	0.013217	0	0	4	18.817659
-1.2	2	-5	2	-0.059936	0.020307	0	0	4	18.817659
-1.175	3	-5	3	-0.065093	0.027397	0	0	4	18.817659
-1.15	4	-5	4	-0.082172	0.031264	0	0	4	18.817659
-1.125	5	-5	5	-0.107309	0.032231	0	0	4	18.817659
-1.1	6	-5	6	-0.145014	0.030619	0	0	4	18.817659
-1.075	7	-5	7	-0.19013	0.024496	0	0	4	18.817659
-1.05	8	-5	8	-0.240081	0.018051	0	0	4	18.821659
-1.025	9	-5	9	-0.293254	0.007739	0	0	4	18.821659
-1	10	-4	0	-0.342238	-0.000318	0	0	4	18.821659

## A4.7 Type B with T

This file is a slightly improved file that includes a time axis item in addition to the items of Type B.

- Data can be exported from and imported to PFV.
- The columns related to the IRIG time (four columns on the right) may not exist.
- The first column is a time axis item.
- There are four-time axis units: sec, msec,  $\mu$ sec, and nsec.
- This file does not have the #UseZeroFrame line of Type A. (PFV always uses 0 frames.)
- Sloap and Intercept store the applied sampling values.
- For example, if #Sampling/Frame is 20, the horizontal axis is “number of channels” x 20.
- The keys (character strings starting with #) and the titles of the data part are case sensitive.

#PHOTRON WAVE DATA									
#SheetType	BwithT								
#Date	2013/12/12								
#Time	15:32:00								
#CameraType	FASTCAM Mini UX100 type 800K-C-16G								
#CameraID	23								
#AnalogBoardType	NIDAQ USB-6251 (BNC)								
#FrameRate(fps)	4000								
#SaveStep	1								
#ShutterSpeed(sec)	1/4000								
#ImageWidth	1280								
#ImageHeight	1024								
#TriggerMode	Manual 8729								
#NumberOfFrames	11								
#FrameRange	-5 to 5								
#SamplingRate(sps)	40000								
#Sampling/Frame	10								
#NumberOfDatas	11								
#Sloap	1								
#Intercept	0								
msec	DataNo	FrameNo	Dev1/ai0-0	Dev1/ai0-1	Dev1/ai0-2	Dev1/ai0-3	Dev1/ai0-4	Dev1/ai0-5	Dev1/ai0-6
-1.25	0	-5	-0.08346	-0.06606	-0.05994	-0.06509	-0.08217	-0.10731	-0.14501
-1	1	-4	-0.34224	-0.3851	-0.42087	-0.44826	-0.4676	-0.4763	-0.47791
-0.75	2	-3	-0.35803	-0.30872	-0.25813	-0.20786	-0.16177	-0.11633	-0.07959
-0.5	3	-2	-0.0087	-0.01611	-0.03061	-0.04286	-0.02545	0.068324	0.248791
-0.25	4	-1	1.795005	2.373788	2.96804	3.551336	4.081459	4.523605	4.834589
0	5	0	5.100135	4.955439	4.693116	4.313811	3.864576	3.411474	3.018958
0.25	6	1	1.965482	1.762456	1.637419	1.634518	1.754722	1.96387	2.196866
0.5	7	2	3.200392	3.507509	3.790133	4.008306	4.139467	4.215521	4.256448
0.75	8	3	3.958677	3.601287	3.151086	2.666403	2.199122	1.796616	1.487244
1	9	4	0.886548	0.882681	0.98226	1.183029	1.458885	1.773091	2.094387
1.25	10	5	3.291914	3.463358	3.498807	3.425009	3.258721	3.061174	2.849448



## A5. Contacting Photron

For inquires related to PFV, contact Photron at the contact information listed below. Additionally, the following items will be verified when inquiring, so prepare them in advance.

Items Verified	Example
Contact Information	Company name, school name, customer name, phone number, etc.
Product Information	<ul style="list-style-type: none"> <li>Version number of Photron FASTCAM Viewer It can be checked from [MENU] - [About PFV] of the PFV menu bar.</li> <li>High speed camera name and firmware version From the LIVE mode tab, click the [  Edit] icon of a camera item in [Function panel] – [Camera controls] and the information can be checked from [Camera name] and [Firmware ver.] in the “Edit Camera Info” dialog.</li> </ul>

Contact Information	
In Americas and Antipodes	<p><b>PHOTRON USA, INC.</b> 9520 Padgett Street, Suite 110, San Diego, CA 92126-4426, USA Phone: +1 (800) 585 2129 or +1 (858) 684 3555 Fax: +1 (858) 684 3558 E-mail: <a href="mailto:image@photron.com">image@photron.com</a> Web: <a href="http://www.photron.com">www.photron.com</a></p>
In UK, Africa and India	<p><b>PHOTRON (EUROPE) LIMITED</b> The Barn, Bottom Road, West Wycombe, Buckinghamshire HP14 4BS, U.K. Phone: +44 (0) 1494 48 1011 Fax: +44 (0) 1494 48 7011 E-mail: <a href="mailto:image@photron.com">image@photron.com</a> Web: <a href="http://www.photron.com">www.photron.com</a></p>
In Europe outside the UK	<p><b>Photron Deutschland GmbH</b> Ziegelweg 3, 72764 Reutlingen, Germany Phone: +49 (0) 7121 699 7950 Fax: +49 (0) 7121 699 7943 E-mail: <a href="mailto:image@photron.com">image@photron.com</a> Web: <a href="http://www.photron.com">www.photron.com</a></p>
In China	<p><b>PHOTRON (SHANGHAI) LIMITED</b> Room 20C Zhao-Feng World Trade Building, No. 369 Jiangsu Road Chang Ning District, Shanghai 200050, China Phone: +86 (21) 5268 3700 Fax: +86 (21) 5268 3702 E-mail: <a href="mailto:info@photron.cn.com">info@photron.cn.com</a> Web: <a href="http://www.photron.cn.com">www.photron.cn.com</a></p>
In other areas	<p><b>PHOTRON LIMITED</b> 21F, Jinbocho Mitsui Bldg., 1-105 Kanda Jimbocho, Chiyoda-Ku, Tokyo 101-0051, Japan Phone: 050 5211 8270 Fax: +81 (3) 3518 6279 E-mail: <a href="mailto:image@photron.co.jp">image@photron.co.jp</a> Web: <a href="http://www.photron.co.jp">www.photron.co.jp</a></p>

# **Photron FASTCAM Viewer**

## **for High-Speed Digital Imaging**

User's Manual Ver. 4.1.0.0 E

Last Updated      November 2023  
Written by         PHOTRON LIMITED  
                         F21, JINBOCHO MITSUI BUILDING,  
                         Kanda Jimbo-cho 101-51, Chiyoda-ku  
                         Tokyo 101, Japan